



SURGICAL INSTRUMENTS CATALOGUE



"PREMIUM QUALITY AND CUSTOMIZATION"

ABOUT US

The company RIMZA INDUSTRIES was established in 1986 and started manufacturing of re-usable medical devices at a small scale with skillful workers. Due to production of high quality surgical and dental instruments, soon it becomes popular among the potential buyers of Europe and worldwide.

Who We Are ?

RIMZA INDUSTRIES is a well established company from Punjab state, Sialkot Pakistan. The renowned 'Gods Own Country'. We are engaged in manufacturing and distribution of 100% pure quality stainless steel Surgical, Dental, Ophthalmic and Beauty care Instruments for all department of surgery since 1995. Our instruments are distributed throughout the world.

We take great pride in the extensive range of over 5,000 quality instruments that we offer in a multitude of disciplines. Our dedicated R&D department has acclaimed many golden feathers in their hat by modifying, designing and manufacturing complex instruments according to surgeon's requirements. Even more importantly, we have a very significant policy of effective 'service after sales' to the satisfaction of our entire clients.

Your satisfaction is our motto! Our Quality We are Certified ISO 9001,13485,14001.CE Class I, is & LLA NB # 1639 (Sterile & Non-Sterile Instruments).

"RIMZA INDUSTRIES Brings Modern Technology For Your Medical Needs"

Corporate Values

People oriented, customer focus, quality first, innovation, improvement and win-win cooperation.

Mission & Objective

Our mission is to supply high quality medical instruments at competitive prices. To exceed our customers' expectations in quality, delivery, and cost through best management practices.

Our Goal

Producing and Internationally Quality Standard Instruments. Improve our Products Quality and After Sales Services to Meet the International Standards.

Scalpel Blades, Scalpel Handles, Knives



No. 3
13,0 cm, 5"
003-003-00



No. 3
13,0 cm, 5"
003-003-01



No. 3L
21,0 cm, 8¼"
003-003-02



No. 7
16,5 cm, 6½"
003-007-00



No. 7K
13,0 cm, 5"
003-007-01



No. 4
13,5 cm, 5³/₈"
003-004-00



No. 4L
21,0 cm, 8³/₈"
003-004-01



No. 8
13,5 cm, 5³/₈"
003-008-00



No. 9
14,5 cm, 5⁷/₈"
003-009-00



Fig. 10
003-050-10



Fig. 11
003-050-11



Fig. 11s
003-050-11S



Fig. 12
003-050-12



Fig. 12d
003-050-12D



Fig. 13
003-050-13



Fig. 15
003-050-15



Fig. 15c
003-050-15C



Fig. 18
003-050-18



Fig. 19
003-050-19



Fig. 20
003-050-20



Fig. 21
003-050-21



Fig. 22
003-050-22



Fig. 23
003-050-23



Fig. 24
003-050-24



Fig. 1 **003-066-01**
 Fig. 2 **003-066-02**
 Fig. 3 **003-066-03**



OPERATION
 17,0 cm, 6¾"

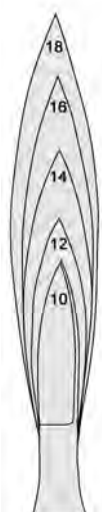

Fig. 10 **003-060-10**
 Fig. 12 **003-060-12**
 Fig. 14 **003-060-14**
 Fig. 16 **003-060-16**
 Fig. 18 **003-060-18**



COLLIN
 16,0 cm, 6¼"



Fig. 4 **003-066-04**
 Fig. 5 **003-066-05**
 Fig. 6 **003-066-06**



Fig. 1 **003-070-01**
 Fig. 2 **003-070-02**
 Fig. 3 **003-070-03**
 Fig. 4 **003-070-04**
 Fig. 5 **003-070-05**



Fig. 1 **003-076-01**
 Fig. 2 **003-076-02**
 Fig. 3 **003-076-03**
 Fig. 4 **003-076-04**
 Fig. 5 **003-076-05**



Fig. 15 **003-078-15**



DISSECTING
 17,0 cm, 6¾"



Fig. 6 **003-070-06**
 Fig. 7 **003-070-07**
 Fig. 8 **003-070-08**
 Fig. 9 **003-070-09**
 Fig. 10 **003-070-10**



DIEFENBACH
 16,0 cm, 6¼"



Fig. 6 **003-076-06**
 Fig. 7 **003-076-07**
 Fig. 8 **003-076-08**
 Fig. 9 **003-076-09**

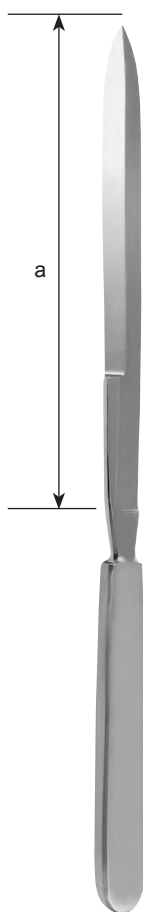

Fig. 16 **003-078-16**



COLLIN

a	
13,0 cm, 5"	003-080-13
16,0 cm, 6 ¹ / ₄ "	003-080-16
19,0 cm, 7 ¹ / ₂ "	003-080-19
22,0 cm, 8 ⁵ / ₈ "	003-080-22
28,0 cm, 11"	003-080-28



CATLIN

A	
16,0 cm, 6 ¹ / ₄ "	003-082-16
19,0 cm, 7 ¹ / ₂ "	003-082-19
22,0 cm, 8 ⁵ / ₈ "	003-082-22

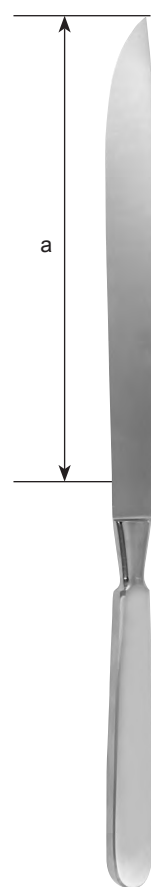

LISTON

A	
17,0 cm, 6 ³ / ₄ "	003-250-17
20,0 cm, 8"	003-250-20
22,0 cm, 8 ⁵ / ₈ "	003-250-22

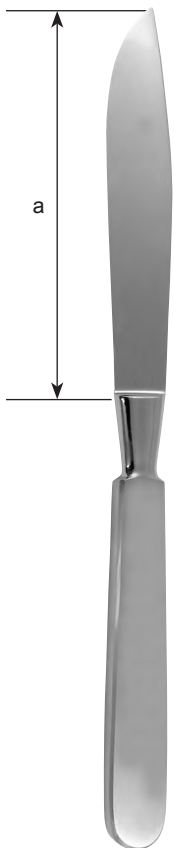

LANGENBECK
003-280-12

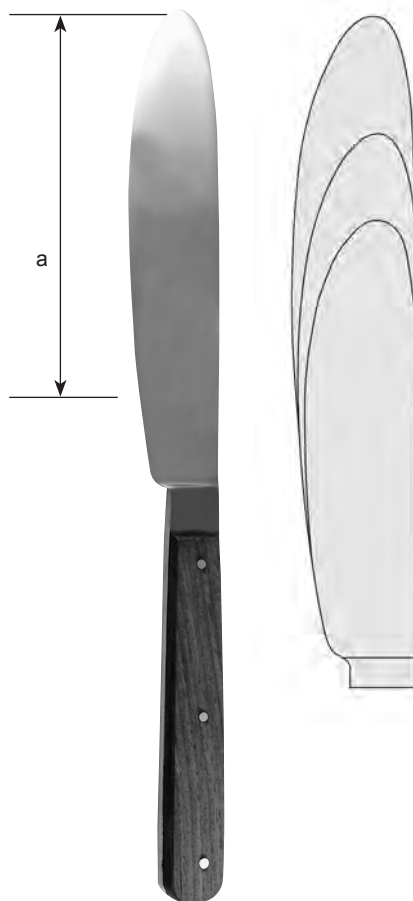

WALB

A	
11,0 cm, 4 1/2"	003-150-11
14,0 cm, 5 1/2"	003-150-14
17,0 cm, 6 3/4"	003-150-17

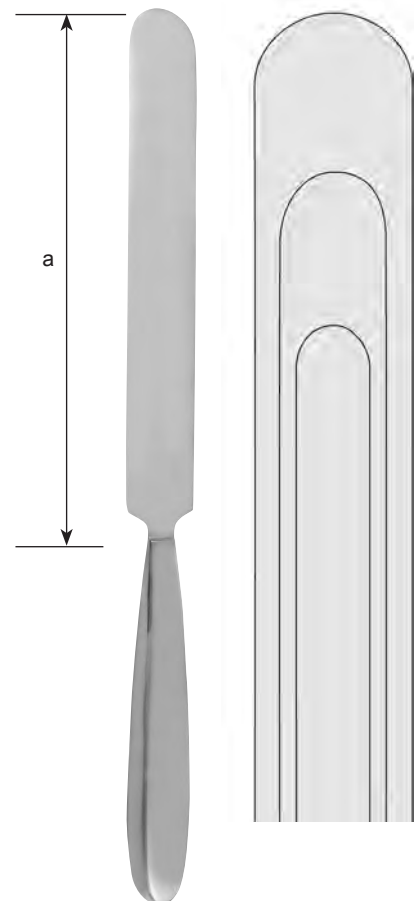

VIRCHOW

A	
16,0 cm, 6 1/4"	003-180-16
20,0 cm, 8"	003-180-20
24,0 cm, 9 1/2"	003-180-24



LANGENBECK
18,0 cm, 7"
003-105-55



CARTILAGE
17,5 cm, 6⁵/₈"
003-110-65

mit Schaber
with raspatory
con periostótomo
con raschiatoio

Haut-Spannplatten
Skin straightening plate
Placa para extender la piel
Placca per stendere la pelle



003-422-30

003-401-19
 Ersatzklinge
 Spare blade
 Hoja de repuesto
 Lama di ricambio



SILVER
 19 cm, 7½"
 003-400-19

003-411-30
 Ersatzklinge
 Spare blade
 Hoja de repuesto
 Lama di ricambio



BRAITHWAITE
 30,0 cm, 12"
 003-410-30

003-413-35
 Ersatzklinge
 Spare blade
 Hoja de repuesto
 Lama di ricambio



HUMBY
 35,0 cm, 14"
 003-412-35

003-421-30
 Ersatzklinge
 Spare blade
 Hoja de repuesto
 Lama di ricambio



SCHINK
 30,0 cm, 12"
 003-420-30

Scissors



STANDARD	
10,5 cm, 4 ¹ / ₄ "	010-000-10
11,5 cm, 4 ¹ / ₂ "	010-000-11
13,0 cm, 5"	010-000-13
14,5 cm, 5 ³ / ₄ "	010-000-14
15,5 cm, 6"	010-000-15
16,5 cm, 6 ¹ / ₂ "	010-000-16
17,5 cm, 6 ⁵ / ₈ "	010-000-17
18,5 cm, 7 ¹ / ₄ "	010-000-18
20,0 cm, 8"	010-000-20



STANDARD	
10,5 cm, 4 ¹ / ₄ "	010-001-10
11,5 cm, 4 ¹ / ₂ "	010-001-11
13,0 cm, 5"	010-001-13
14,5 cm, 5 ³ / ₄ "	010-001-14
15,5 cm, 6"	010-001-15
16,5 cm, 6 ¹ / ₂ "	010-001-16
17,5 cm, 6 ⁵ / ₈ "	010-001-17
18,5 cm, 7 ¹ / ₄ "	010-001-18
20,0 cm, 8"	010-001-20

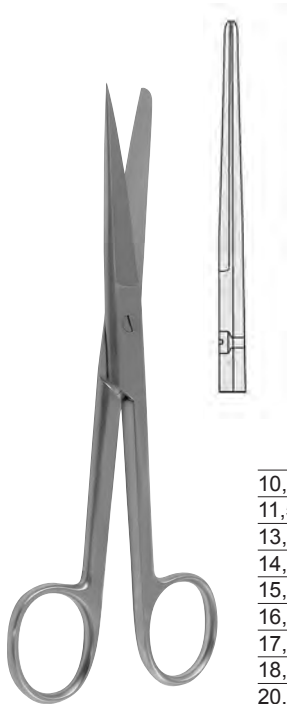

STANDARD	
10,5 cm, 4 ¹ / ₄ "	010-002-10
11,5 cm, 4 ¹ / ₂ "	010-002-11
13,0 cm, 5"	010-002-13
14,5 cm, 5 ³ / ₄ "	010-002-14
15,5 cm, 6"	010-002-15
16,5 cm, 6 ¹ / ₂ "	010-002-16
17,5 cm, 6 ⁵ / ₈ "	010-002-17
18,5 cm, 7 ¹ / ₄ "	010-002-18
20,0 cm, 8"	010-002-20

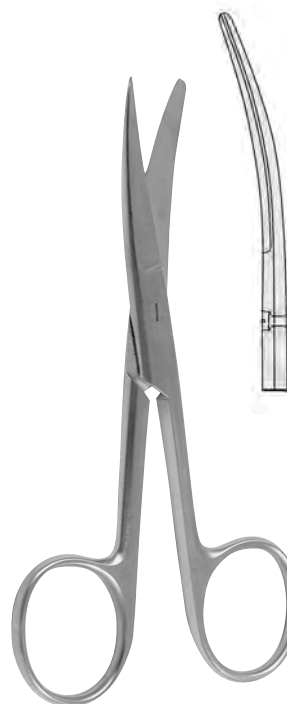

STANDARD	
10,5 cm, 4 ¹ / ₄ "	010-003-10
11,5 cm, 4 ¹ / ₂ "	010-003-11
13,0 cm, 5"	010-003-13
14,5 cm, 5 ³ / ₄ "	010-003-14
15,5 cm, 6"	010-003-15
16,5 cm, 6 ¹ / ₂ "	010-003-16
17,5 cm, 6 ⁵ / ₈ "	010-003-17
18,5 cm, 7 ¹ / ₄ "	010-003-18
20,0 cm, 8"	010-003-20

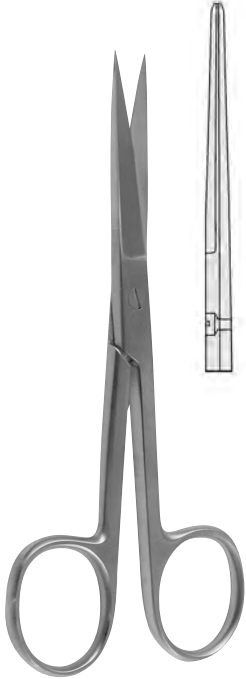

STANDARD	
10,5 cm, 4 ¹ / ₄ "	010-004-10
11,5 cm, 4 ¹ / ₂ "	010-004-11
13,0 cm, 5"	010-004-13
14,5 cm, 5 ³ / ₄ "	010-004-14
15,5 cm, 6"	010-004-15
16,5 cm, 6 ¹ / ₂ "	010-004-16
17,5 cm, 6 ⁵ / ₈ "	010-004-17
18,5 cm, 7 ¹ / ₄ "	010-004-18
20,0 cm, 8"	010-004-20

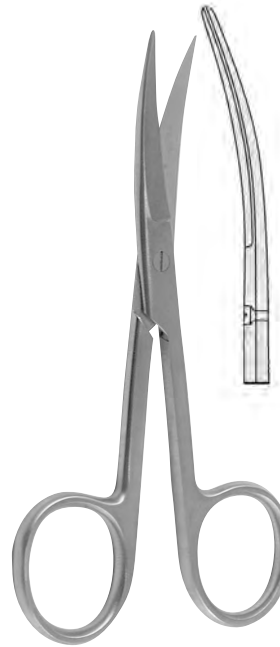

STANDARD	
10,5 cm, 4 ¹ / ₄ "	010-005-10
11,5 cm, 4 ¹ / ₂ "	010-005-11
13,0 cm, 5"	010-005-13
14,5 cm, 5 ³ / ₄ "	010-005-14
15,5 cm, 6"	010-005-15
16,5 cm, 6 ¹ / ₂ "	010-005-16
17,5 cm, 6 ⁵ / ₈ "	010-005-17
18,5 cm, 7 ¹ / ₄ "	010-005-18
20,0 cm, 8"	010-005-20



DEAVER	
12,0 cm, 4 ³ / ₄ "	010-050-12
13,0 cm, 5"	010-050-13
14,5 cm, 5 ³ / ₄ "	010-050-14

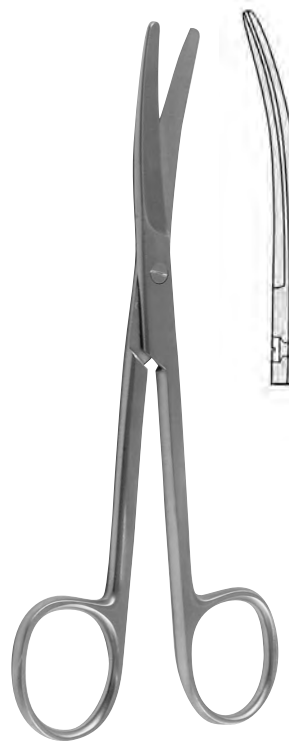

DEAVER	
12,0 cm, 4 ³ / ₄ "	010-051-12
13,0 cm, 5"	010-051-13
14,5 cm, 5 ³ / ₄ "	010-051-14

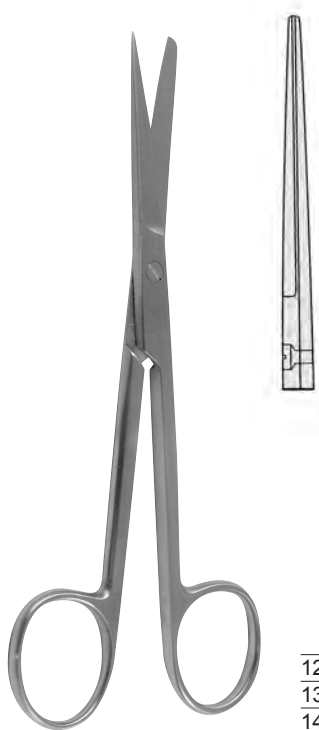

DEAVER

12,0 cm, 4 ³ / ₄ "	010-052-12
13,0 cm, 5"	010-052-13
14,5 cm, 5 ³ / ₄ "	010-052-14

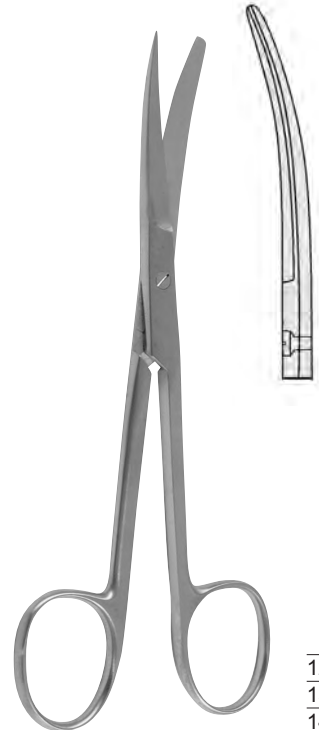

DEAVER

12,0 cm, 4 ³ / ₄ "	010-053-12
13,0 cm, 5"	010-053-13
14,5 cm, 5 ³ / ₄ "	010-053-14

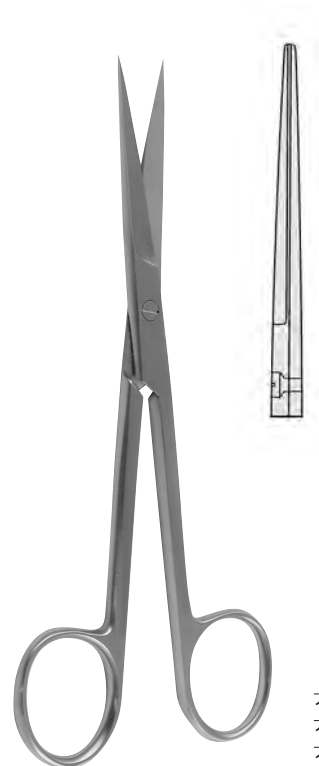

DEAVER

12,0 cm, 4 ³ / ₄ "	010-054-12
13,0 cm, 5"	010-054-13
14,5 cm, 5 ³ / ₄ "	010-054-14

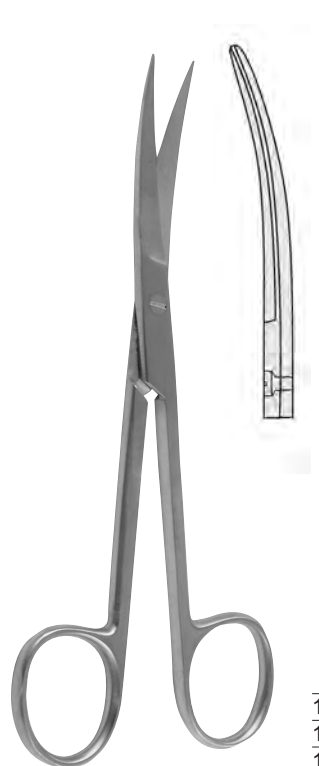

DEAVER

12,0 cm, 4 ³ / ₄ "	010-055-12
13,0 cm, 5"	010-055-13
14,5 cm, 5 ³ / ₄ "	010-055-14

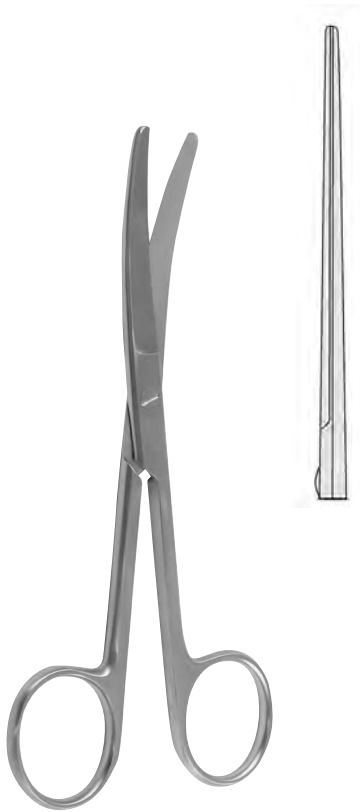

GRAZIL
 13,0 cm, 5" **010-070-13**
 14,5 cm, 5³/₄" **010-070-14**

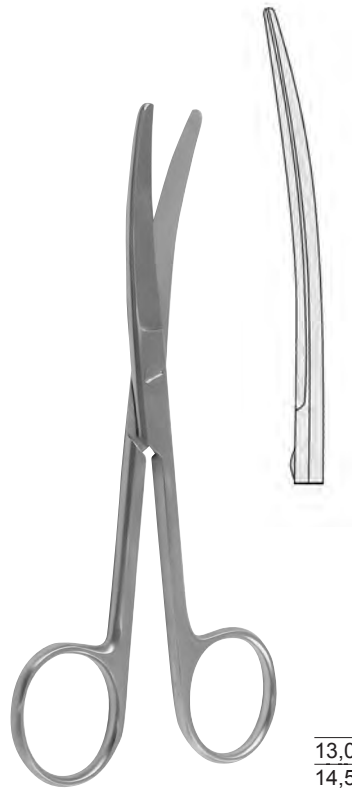

GRAZIL
 13,0 cm, 5" **010-071-13**
 14,5 cm, 5³/₄" **010-071-14**

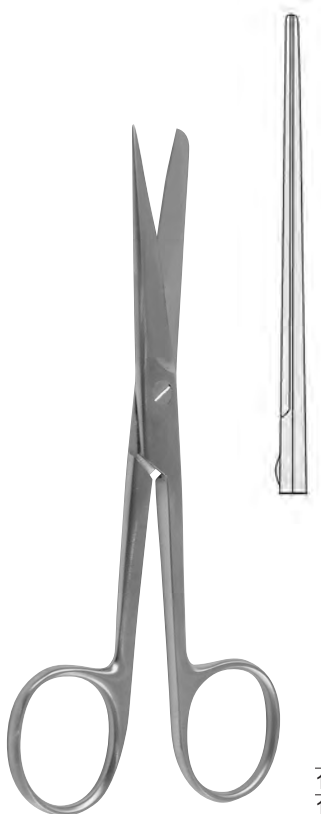

GRAZIL
 13,0 cm, 5" **010-072-13**
 14,5 cm, 5³/₄" **010-072-14**

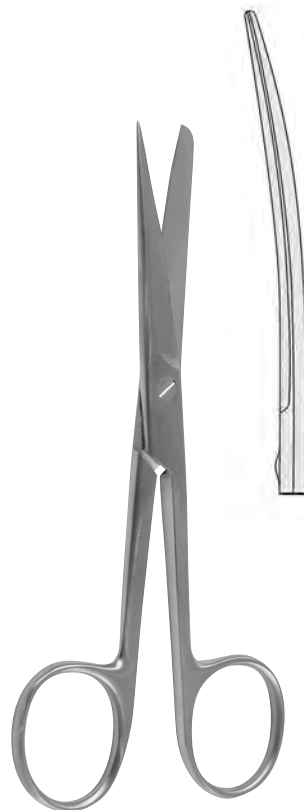

GRAZIL
 13,0 cm, 5" **010-073-13**
 14,5 cm, 5³/₄" **010-073-14**

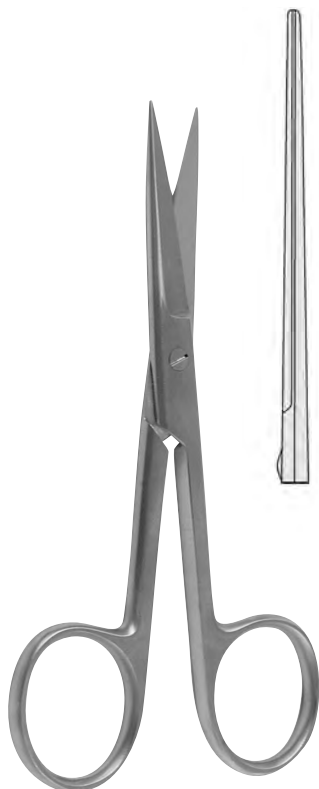

GRAZIL
 13,0 cm, 5" **010-074-13**
 14,5 cm, 5³/₄" **010-074-14**



GRAZIL
 13,0 cm, 5" **010-075-13**
 14,5 cm, 5³/₄" **010-075-14**

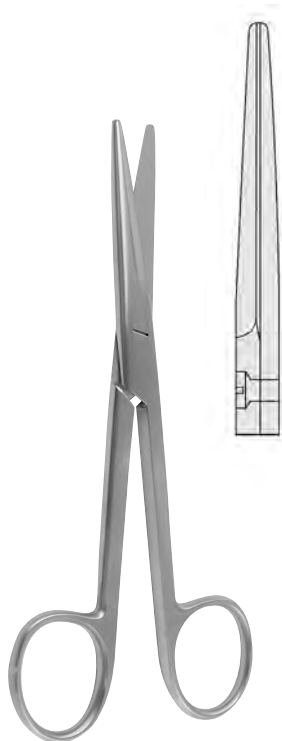

MAYO
 14,5 cm, 5³/₄" **010-100-14**
 17,0 cm, 6³/₄" **010-100-17**
 23,0 cm, 9" **010-100-23**
 28,0 cm, 11" **010-100-28**

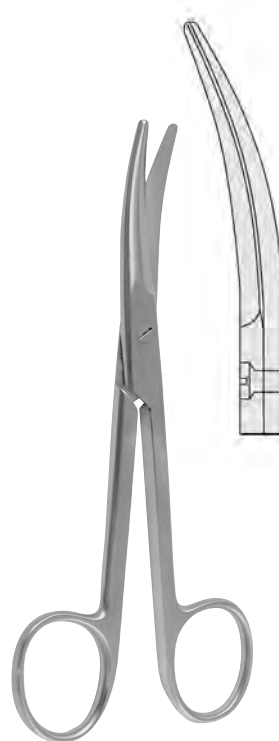

MAYO
 14,5 cm, 5³/₄" **010-101-14**
 17,0 cm, 6³/₄" **010-101-17**
 23,0 cm, 9" **010-101-23**
 28,0 cm, 11" **010-101-28**

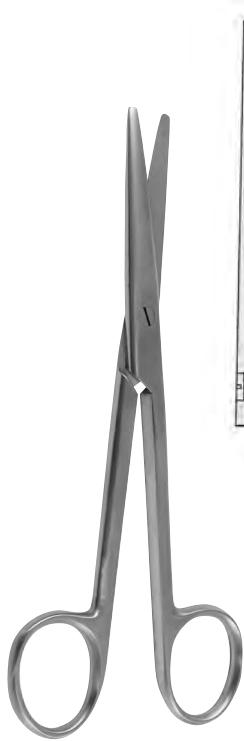

MAYO-STILE

15,0 cm, 6"	010-102-15
17,0 cm, 6 ³ / ₄ "	010-102-17
19,5 cm, 7 ³ / ₄ "	010-102-19
21,0 cm, 8 ¹ / ₄ "	010-102-21



MAYO-STILE

15,0 cm, 6"	010-103-15
17,0 cm, 6 ³ / ₄ "	010-103-17
19,5 cm, 7 ³ / ₄ "	010-103-19
21,0 cm, 8 ¹ / ₄ "	010-103-21



010-104-17



010-105-17

MAYO-NOBLE

17,0 cm, 6³/₄"



FOMON

13,5 cm, 5³/₈" **010-009-13**



BABY-METZENBAUM
11,5 cm, 4¹/₂"

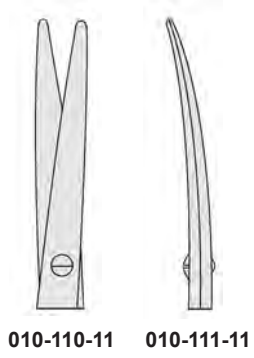

METZENBAUM
14,5 cm, 5³/₄"

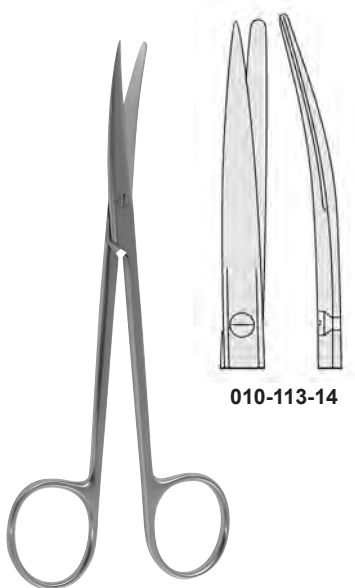
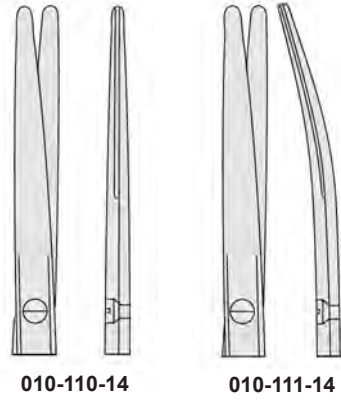

METZENBAUM
14,5 cm, 5³/₄"

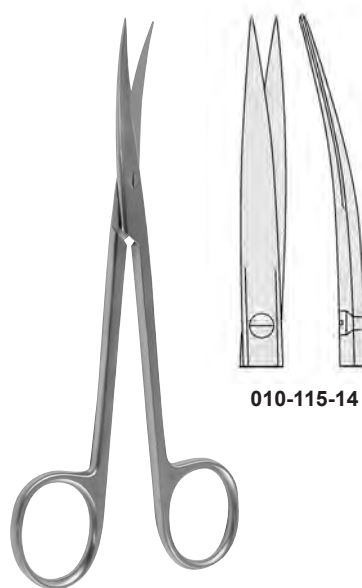
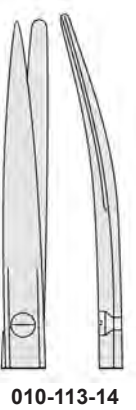

METZENBAUM
14,5 cm, 5³/₄"





METZENBAUM

18,0 cm, 7"
 20,0 cm, 8"
 23,0 cm, 9"
 25,0 cm, 10"
 28,0 cm, 11"
 30,0 cm, 12"

010-110-18
010-110-20
010-110-23
010-110-25
010-110-28
010-110-30

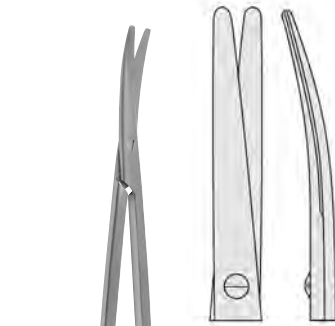

METZENBAUM

18,0 cm, 7"
 20,0 cm, 8"
 23,0 cm, 9"
 25,0 cm, 10"
 28,0 cm, 11"
 30,0 cm, 12"

010-111-18
010-111-20
010-111-23
010-111-25
010-111-28
010-111-30

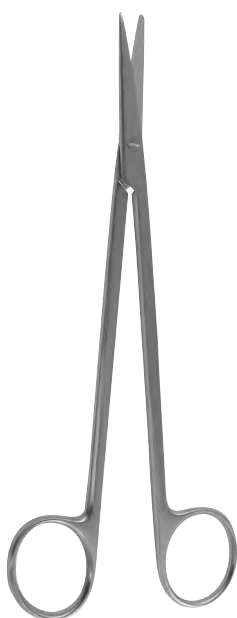

METZENBAUM

18,0 cm, 7"
 20,0 cm, 8"
 23,0 cm, 9"
 25,0 cm, 10"
 28,0 cm, 11"
 30,0 cm, 12"

010-112-18
010-112-20
010-112-23
010-112-25
010-112-28
010-112-30

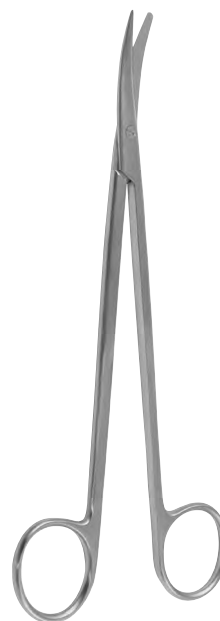

METZENBAUM

18,0 cm, 7"
 20,0 cm, 8"
 23,0 cm, 9"
 25,0 cm, 10"
 28,0 cm, 11"
 30,0 cm, 12"



010-113-18
010-113-20
010-113-23
010-113-25
010-113-28
010-113-30



METZENBAUM

<u>18,0 cm, 7"</u>
<u>20,0 cm, 8"</u>
<u>23,0 cm, 9"</u>
<u>25,0 cm, 10"</u>
<u>28,0 cm, 11"</u>
<u>30,0 cm, 12"</u>

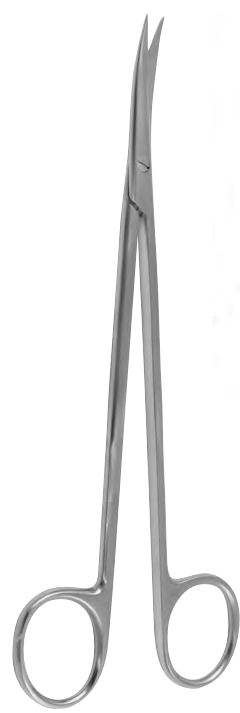
- 010-114-18**
- 010-114-20**
- 010-114-23**
- 010-114-25**
- 010-114-28**
- 010-114-30**

METZENBAUM

<u>18,0 cm, 7"</u>
<u>20,0 cm, 8"</u>
<u>23,0 cm, 9"</u>
<u>25,0 cm, 10"</u>
<u>28,0 cm, 11"</u>
<u>30,0 cm, 12"</u>

- 010-115-18**
- 010-115-20**
- 010-115-23**
- 010-115-25**
- 010-115-28**
- 010-115-30**

METZENBAUM-FINO

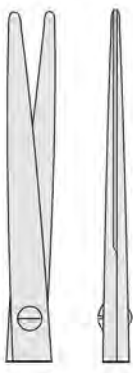
14,5 cm, 5³/₄"

010-120-14

010-121-14

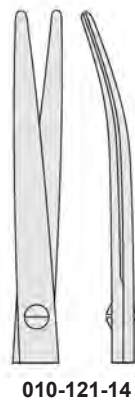
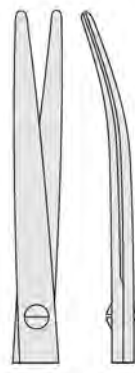

METZENBAUM-FINO

<u>18,0 cm, 7"</u>
<u>20,0 cm, 8"</u>
<u>23,0 cm, 9"</u>
<u>25,0 cm, 10"</u>
<u>28,0 cm, 11"</u>
<u>30,0 cm, 12"</u>

- 010-120-18**
- 010-120-20**
- 010-120-23**
- 010-120-25**
- 010-120-28**
- 010-120-30**

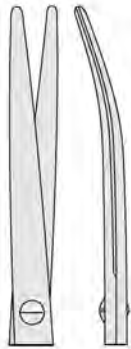

18,0 cm, 7"
20,0 cm, 8"
23,0 cm, 9"
25,0 cm, 10"
28,0 cm, 11"
30,0 cm, 12"

METZENBAUM-FINO

010-121-18
010-121-20
010-121-23
010-121-25
010-121-28
010-121-30

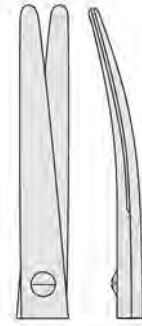

010-124-14

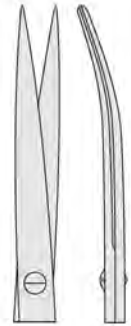

010-125-14

METZENBAUM-FINO
14,5 cm, 5³/₄"

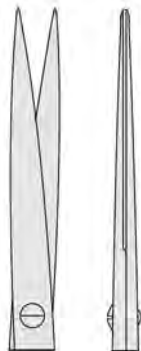

18,0 cm, 7"
20,0 cm, 8"
23,0 cm, 9"
25,0 cm, 10"
28,0 cm, 11"
30,0 cm, 12"

METZENBAUM-FINO

010-124-18
010-124-20
010-124-23
010-124-25
010-124-28
010-124-30

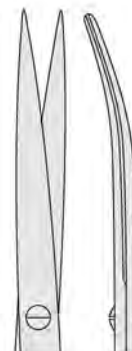

18,0 cm, 7"
20,0 cm, 8"
23,0 cm, 9"
25,0 cm, 10"
28,0 cm, 11"
30,0 cm, 12"

METZENBAUM-FINO

010-125-18
010-125-20
010-125-23
010-125-25
010-125-28
010-125-30

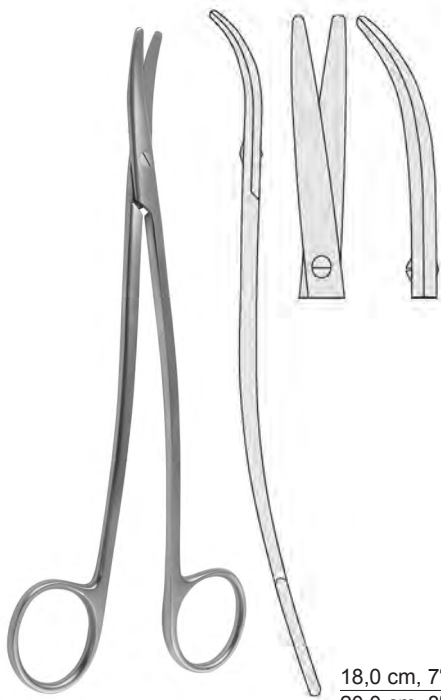

METZENBAUM-FINO S

18,0 cm, 7"
20,0 cm, 8"
23,0 cm, 9"

010-127-18
010-127-20
010-127-23

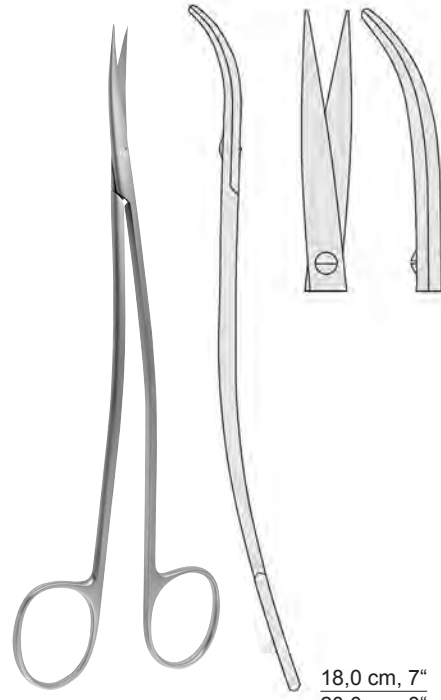

METZENBAUM-FINO S

18,0 cm, 7"
20,0 cm, 8"
23,0 cm, 9"

010-129-18
010-129-20
010-129-23



METZENBAUM-LAHEY

14,0 cm, 5 1/2" **010-137-14**

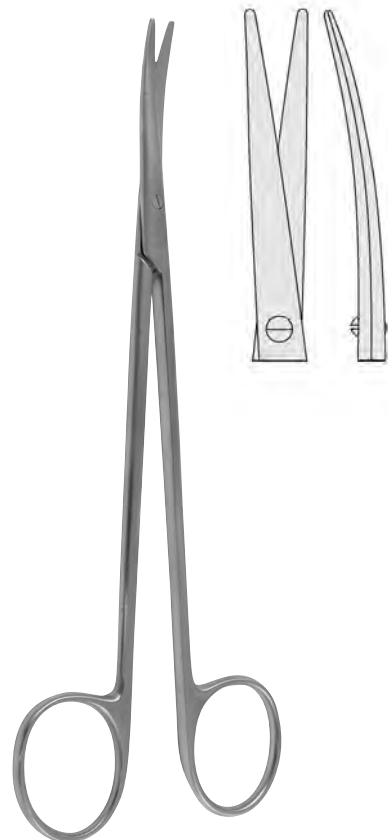

TOENNIS-ADSON

17,0 cm, 6 3/4" **010-139-17**

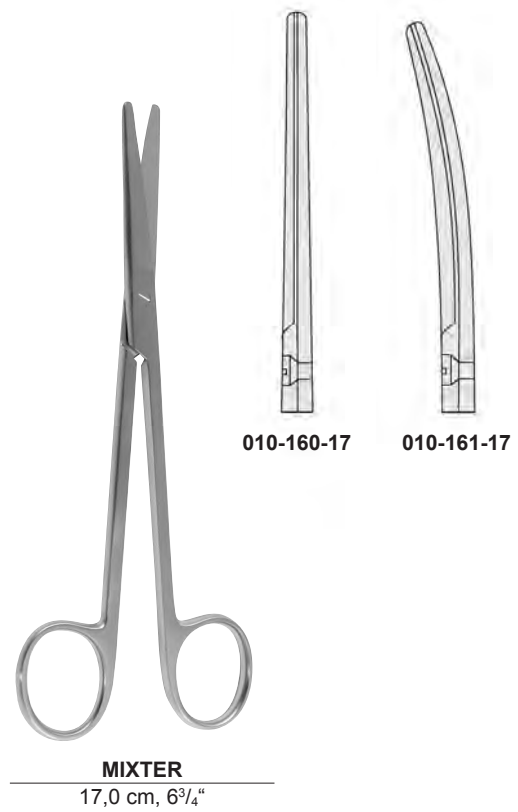
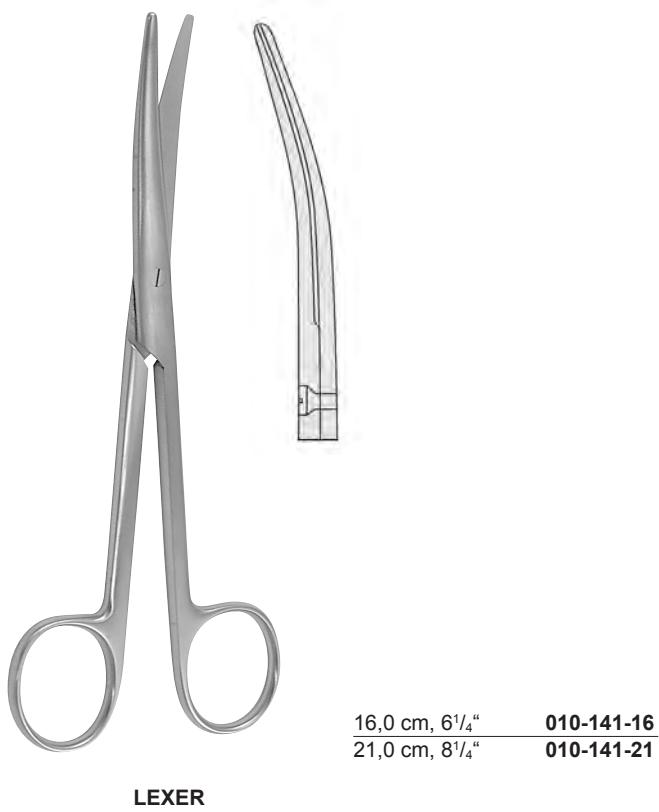



12,0 cm, 4 ³ / ₄ "	010-200-12
15,0 cm, 6"	010-200-15
18,0 cm, 7"	010-200-18
20,0 cm, 8"	010-200-20

KILNER (RAGNELL)



12,0 cm, 4 ³ / ₄ "	010-201-12
15,0 cm, 6"	010-201-15
18,0 cm, 7"	010-201-18
20,0 cm, 8"	010-201-20

KILNER (RAGNELL)



15,0 cm, 6"	010-210-15
18,0 cm, 7"	010-210-18

REYNOLDS

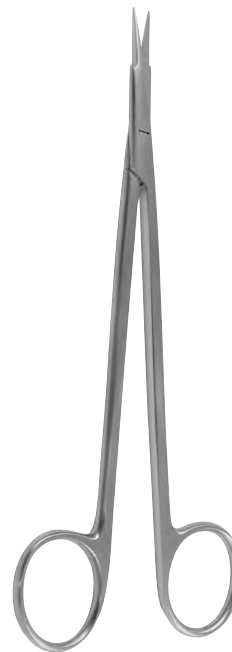

15,0 cm, 6"	010-211-15
18,0 cm, 7"	010-211-18
20,0 cm, 8"	010-211-20
23,0 cm, 9"	010-211-23
25,0 cm, 10"	010-211-25

REYNOLDS

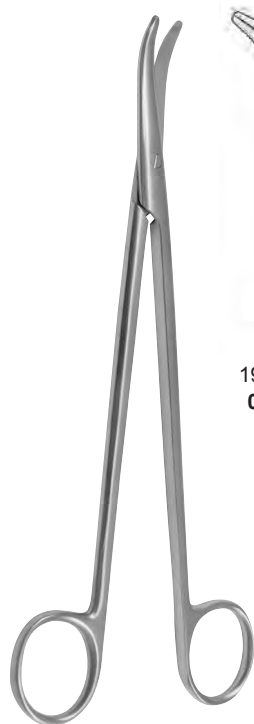

THOREK

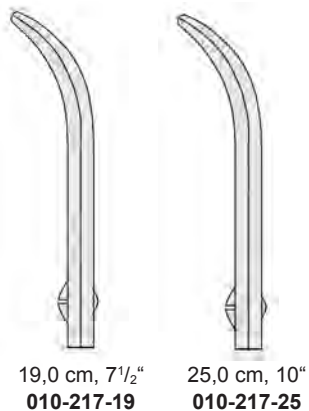

19,0 cm, 7 1/2"
010-217-19

25,0 cm, 10"
010-217-25

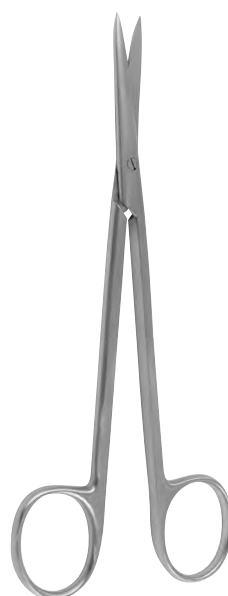

15,0 cm, 6"

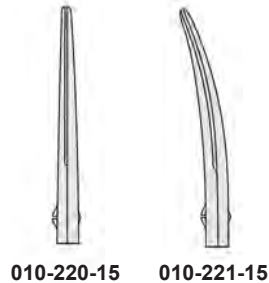

010-220-15

010-221-15

Nerv-Präparierscheren
Nerve dissecting scissors
Tijeras para nervios
Forbici per dissezione di nervi



SANVENERO
14,0 cm, 5 1/2"

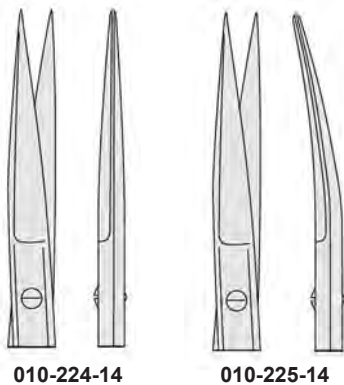

010-224-14

010-225-14



JOSEPH
14,0 cm, 5 1/2"

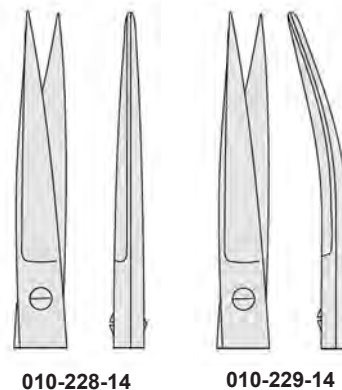

010-228-14

010-229-14



WAGNER
12,0 cm, 4³/₄"



010-230-12



010-231-12



010-234-12



010-235-12



STRABISMUS
11,5 cm, 4¹/₂"



010-240-11



010-241-11



IRIS



9,0 cm, 4 ¹ / ₈ "	010-244-09
10,5 cm, 4 ¹ / ₈ "	010-244-10
11,5 cm, 4 ¹ / ₂ "	010-244-11



IRIS



9,0 cm, 4 ¹ / ₈ "	010-245-09
10,5 cm, 4 ¹ / ₈ "	010-245-10
11,5 cm, 4 ¹ / ₂ "	010-245-11

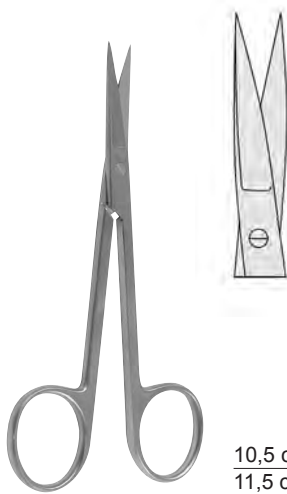

10,5 cm, 4¹/₈" **010-250-10**
11,5 cm, 4¹/₂" **010-250-11**

IRIS

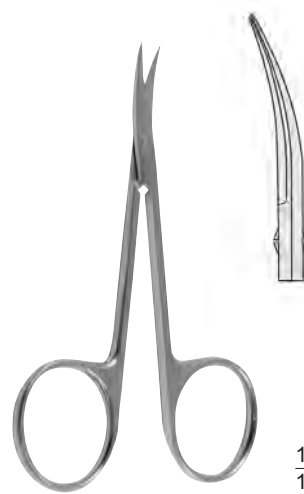

10,5 cm, 4¹/₈" **010-251-10**
11,5 cm, 4¹/₂" **010-251-11**

IRIS



11,5 cm, 4¹/₂"
010-261-11



11,5 cm, 4¹/₂"
010-263-11



12,0 cm, 4³/₄"



010-264-12



010-265-12



MOD. BONN
8,0 cm, 3¹/₄"
010-270-08



MOD. BONN
8,0 cm, 3¹/₄"
010-271-08



MOD. BONN
8,0 cm, 3¹/₄"
010-273-08

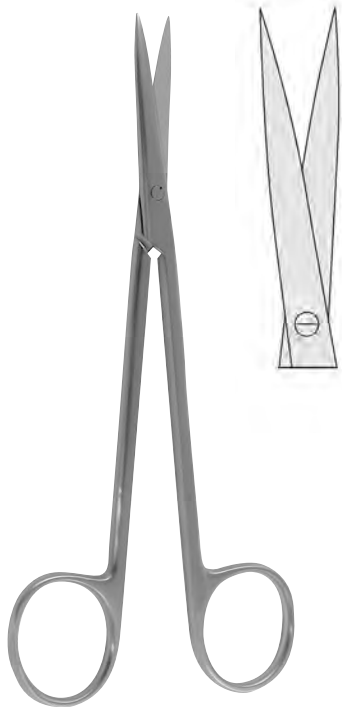

BROPHY (SULLIVAN)
14,0 cm, 5 1/2"
010-276-14



BROPHY (SULLIVAN)
14,0 cm, 5 1/2"
010-277-14



LANDOLT
12,5 cm, 5"

010-280-12 010-283-12 010-285-12

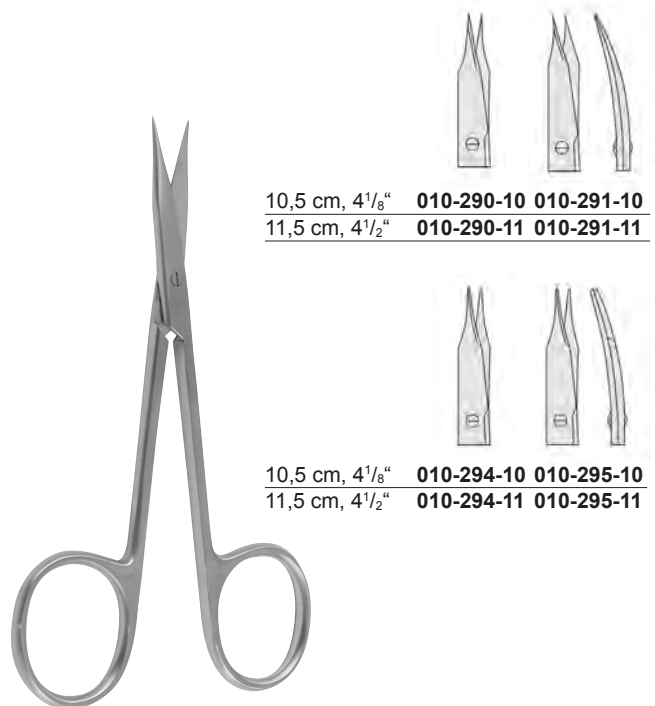

10,5 cm, 4 1/8" 010-290-10 010-291-10
11,5 cm, 4 1/2" 010-290-11 010-291-11

10,5 cm, 4 1/8" 010-294-10 010-295-10
11,5 cm, 4 1/2" 010-294-11 010-295-11

STEVENS



Inzisionsscheren
Incision scissors
Tijeras para incisión
Forbici vascolare e per fistole

13,0 cm, 5"
14,5 cm, 5³/₄"

010-300-13
010-300-14



RICHTER
14,5 cm, 5³/₄"
010-310-14



FERGUSSON
16,5 cm, 6¹/₄" **010-315-16**
18,0 cm, 7" **010-315-18**

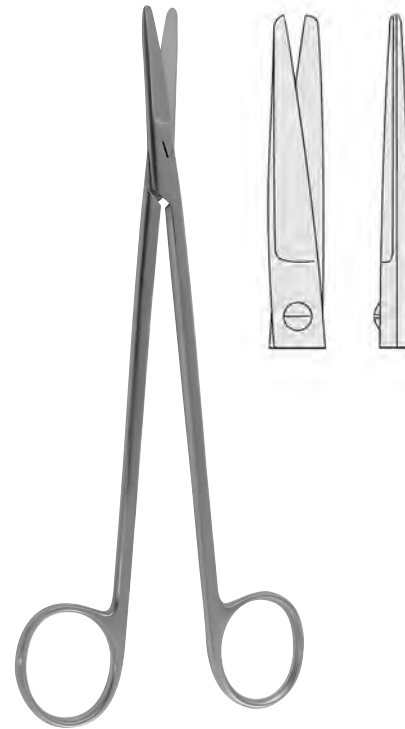

TOENNIS
18,0 cm, 7"
010-324-18



TOENNIS
18,0 cm, 7"
010-325-18

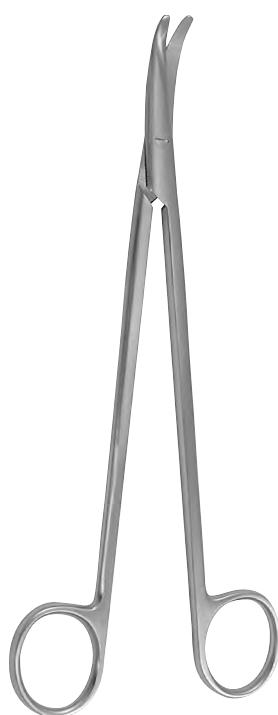
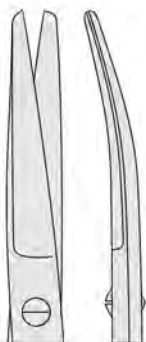

HALLE
19,0 cm, 7½"
010-341-19



FOMON
15,0 cm, 6"
010-343-15



SPENCER
9,0 cm, 4⅛"
10,5 cm, 4⅓"
13,0 cm, 5"
010-400-09
010-400-10
010-400-13



LITTAUER
11,5 cm, 4¼"
14,0 cm, 5½"
010-402-11
010-402-14

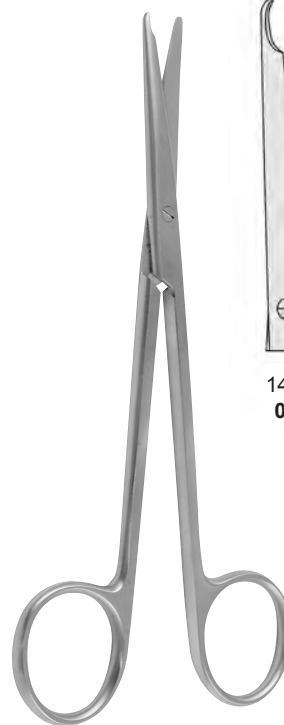

BUCK

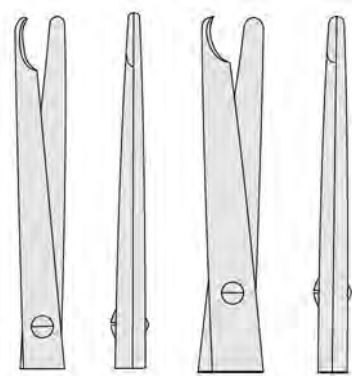

14,5 cm, 5¾"
010-404-14

18,0 cm, 7"
010-404-18

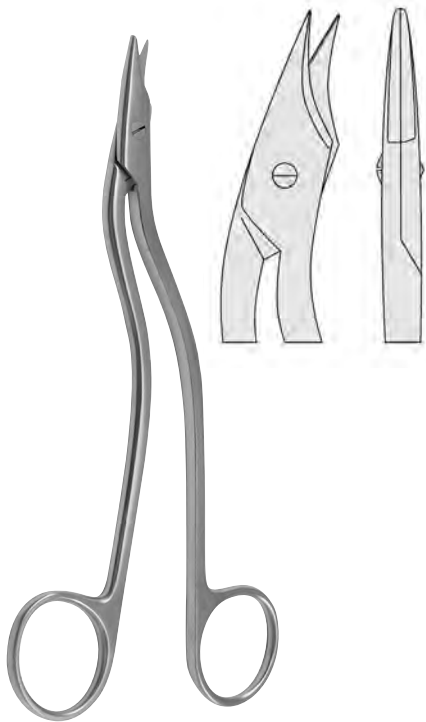

HEATH
16,0 cm, 6¹/₄"
010-408-16



NORTHBENT
9,0 cm, 3¹/₂"
010-411-19



NORTHBENT
13,0 cm, 5"
010-413-13



EISELSBERG
12,0 cm, 4³/₄"
010-415-12

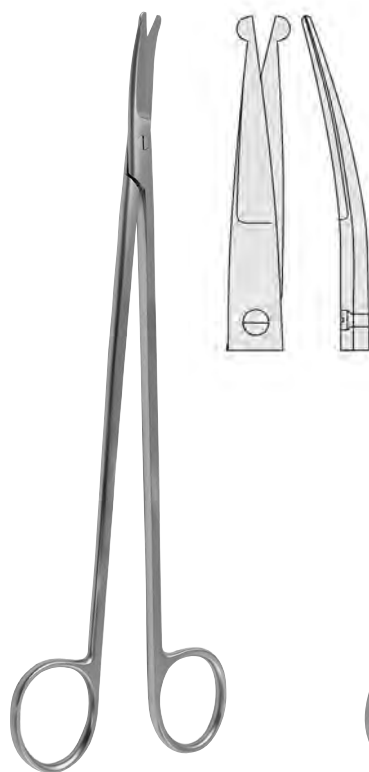

STRULLY
22,0 cm, 8⁵/₈"
010-450-22

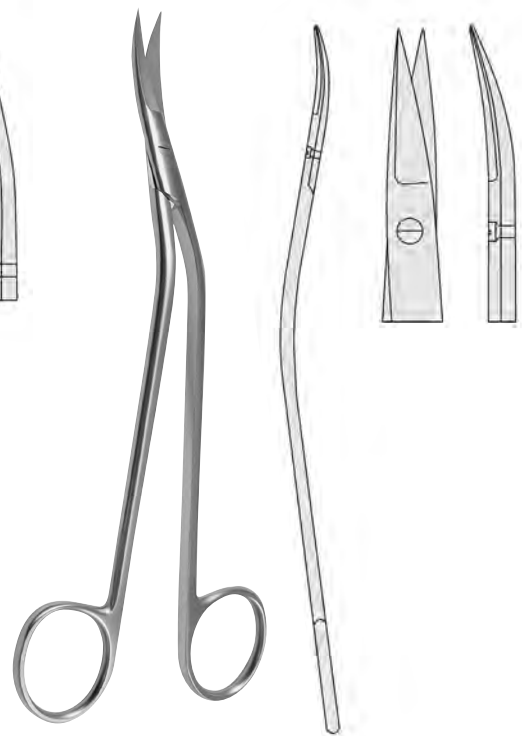

DANDY
17,0 cm, 6³/₄"
010-453-17

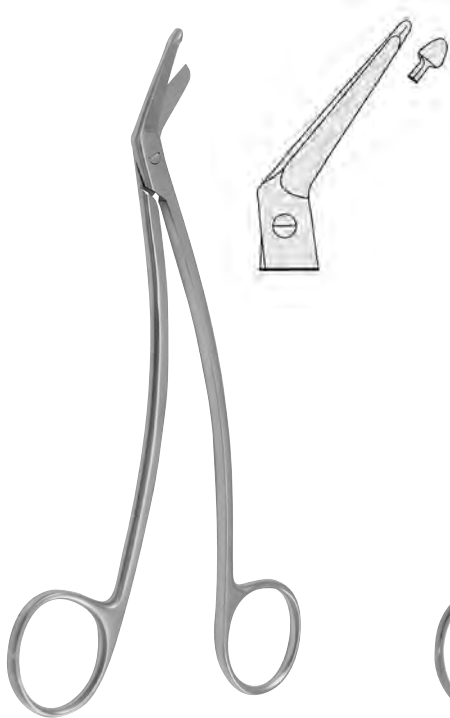

SCHMIEDEN-TAYLOR
17,0 cm, 6³/₄"
010-457-17



LINCOLN
17,0 cm, 6³/₄"



HEYMANN
18,0 cm, 7"
010-501-18

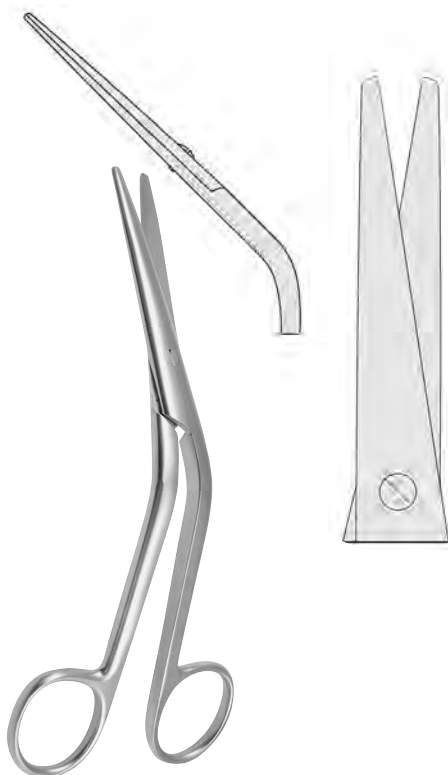

COTTLE
16,0 cm, 6¹/₄"
010-511-16



KIRSTEN
18,0 cm, 7"
010-517-18



CAPLAN
22,0 cm, 8⁵/₈"
010-519-22



BOETTCHER
18,0 cm, 7"
010-521-18

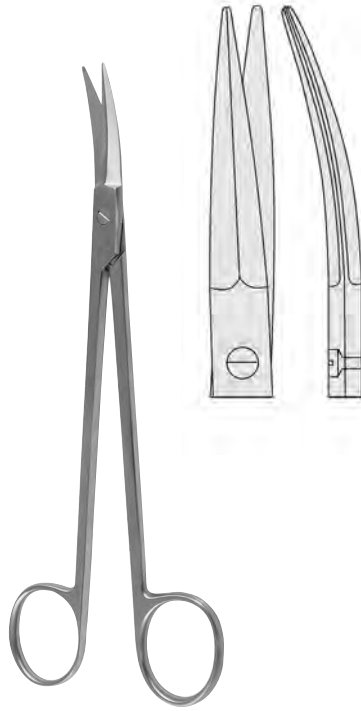

PRINCE
17,5 cm, 6⁵/₈"
010-523-17

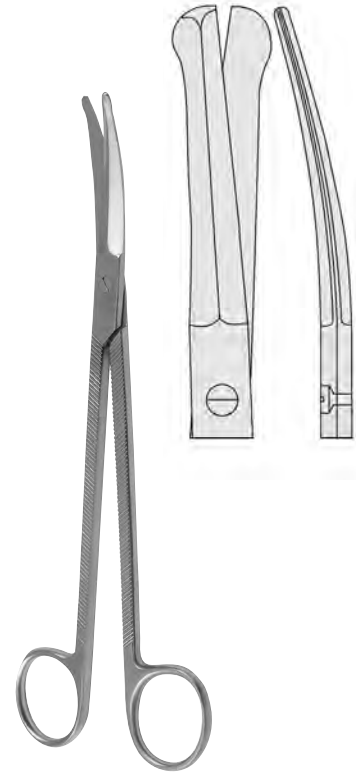

GOOD
19,0 cm, 7¹/₂"
010-525-19



CARTILAGE
20,0 cm, 8"
010-528-20

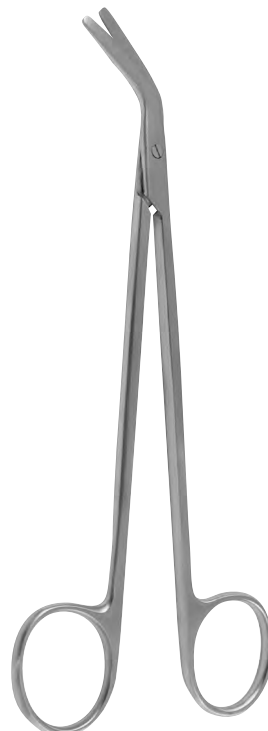

DE BAKEY

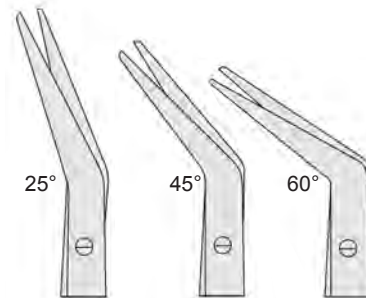

17,5 cm, 6 ⁵ / ₈ "	010-540-25	010-540-45	010-540-60
19,5 cm, 7 ³ / ₄ "	010-541-25	010-541-45	010-541-60
21,0 cm, 8 ¹ / ₄ "	010-542-25	010-542-45	010-542-60
23,0 cm, 9"	010-543-25	010-543-45	010-543-60
28,0 cm, 11"	010-544-25	010-544-45	010-544-60

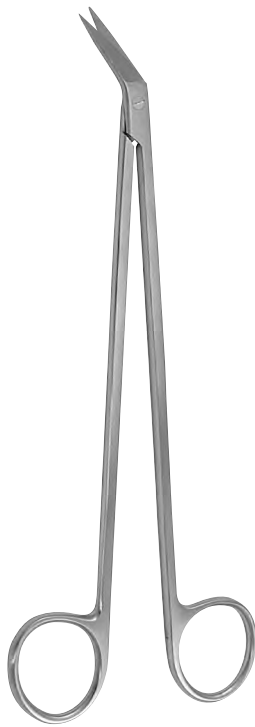

POTTS-SMITH
18,0 cm, 7"
010-547-18

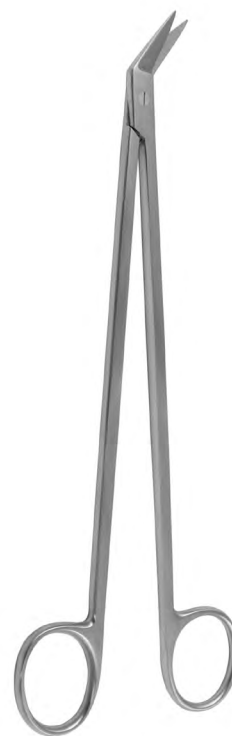
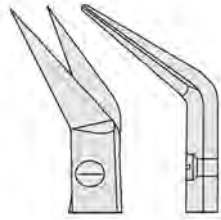

POTTS DE MARTEL
21,0 cm, 8 1/4" 010-548-21
24,0 cm, 9 1/2" 010-548-24

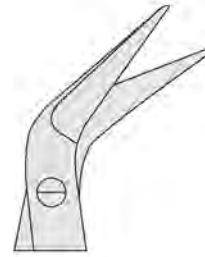

DIETRICH-HEGEMANN
19,0 cm, 7 1/2"

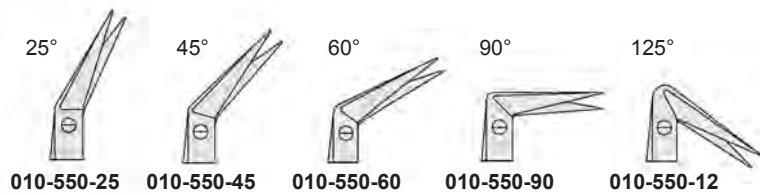



DIETRICH
20,0 cm, 7 1/2"
010-552-12

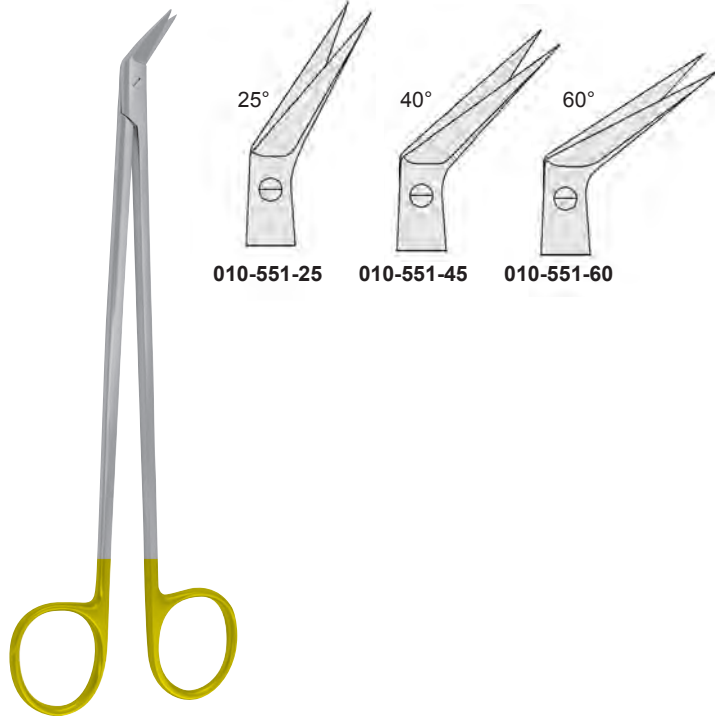

POTTS-SMITH
19,0 cm, 7 1/2"

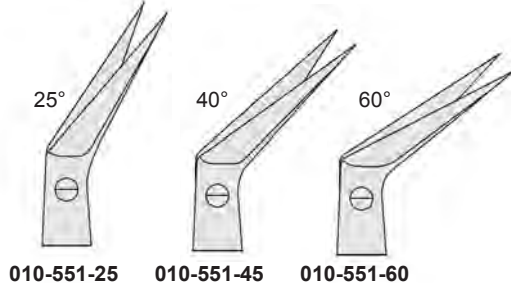

010-551-25 010-551-45 010-551-60

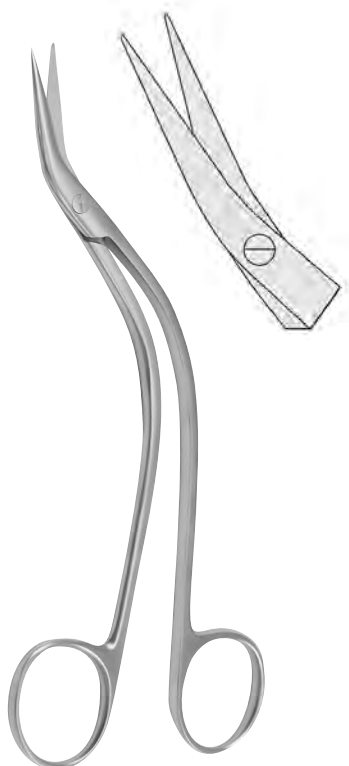

DE BAKEY
15,5 cm, 6"
010-560-15

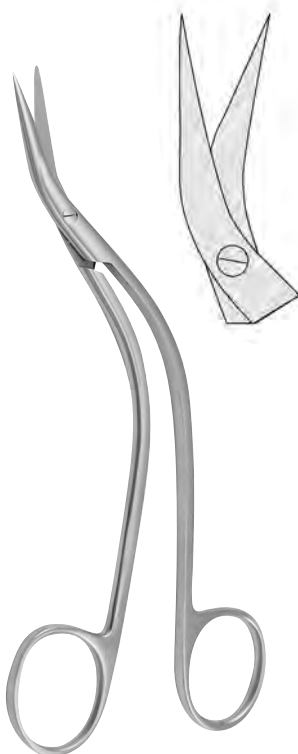

DE BAKEY
15,5 cm, 6"
010-561-15

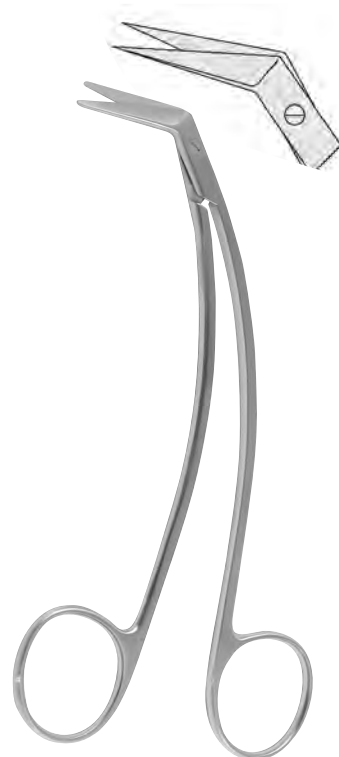

DE BAKEY
15,5 cm, 6"
010-562-15

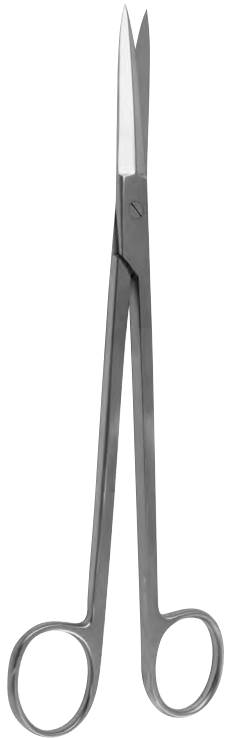

MC INDOE
19,0 cm, 7½"
010-570-19

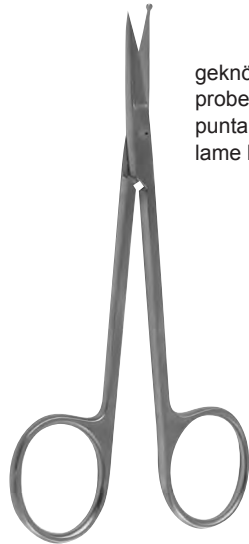

geknöpftes Blatt
probe-pointed blade
punta botonda
lame bottonuta

11,5 cm, 4½"
010-572-11



CRAFOORD
30,0 cm, 12"
010-575-30



SATINSKY
15,5 cm, 9⅝"
010-577-24

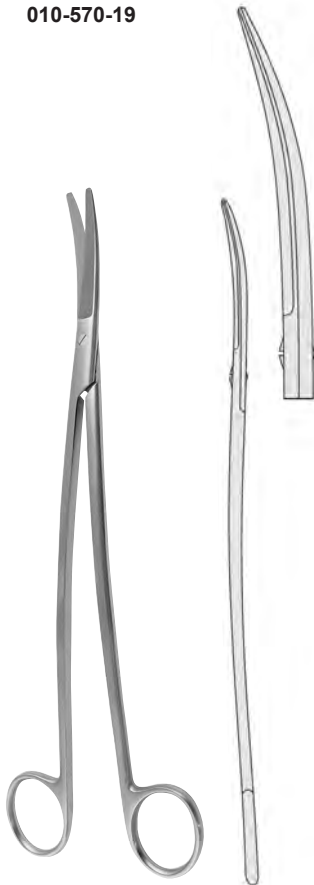

KLINGENBERG-LOTH
23,0 cm, 9"
010-579-23



SIMS



20,0 cm, 8" 010-600-20 010-602-20 010-604-20
23,0 cm, 9" 010-600-23 010-602-23 010-604-23

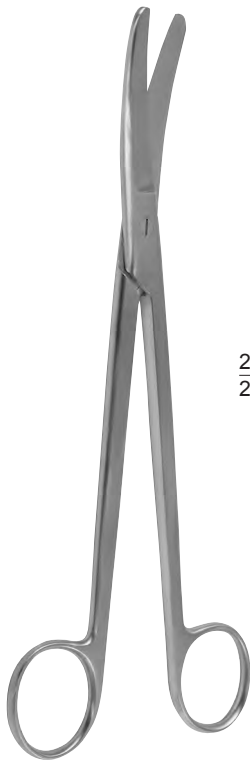

SIMS

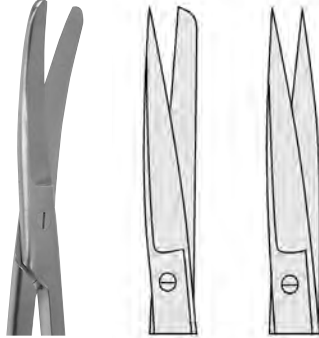

20,0 cm, 8"	010-601-20	010-603-20	010-605-20
23,0 cm, 9"	010-601-23	010-603-23	010-605-23



SIEBOLD
24,0 cm, 9 1/2"
010-620-24



BOZEMANN
22,0 cm, 8 3/4"
010-622-22



DOYEN

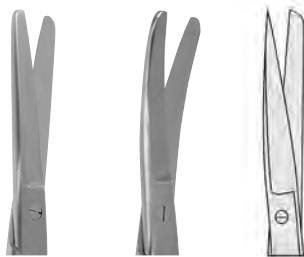

16,0 cm, 6 1/4"	010-610-16	010-611-16	010-612-16
17,5 cm, 6 5/8"	010-610-17	010-611-17	

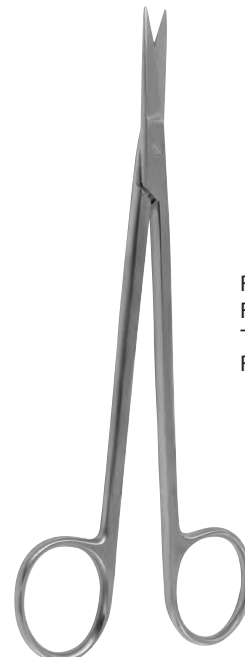

KELLY
16,0 cm, 6 1/4" **010-634-16**
18,0 cm, 7" **010-634-18**

Fistelscheren
Fistula scissors
Tijeras para fistulas
Forbici per fistole

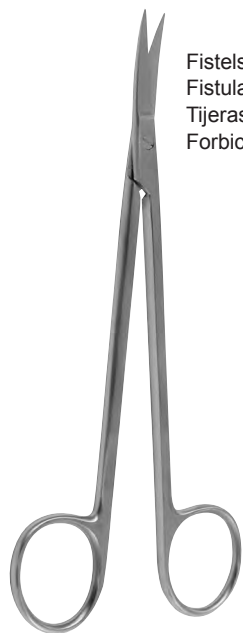

Fistelscheren
Fistula scissors
Tijeras para fistulas
Forbici per fistole

KELLY

16,0 cm, 6¹/₄" **010-635-16**
18,0 cm, 7" **010-635-18**



WERTHEIM

19,5 cm, 7³/₄" **010-640-19**
22,5 cm, 8³/₄" **010-640-23**



DUBOIS

27,0 cm, 10⁵/₈" **010-650-18**

010-651-18

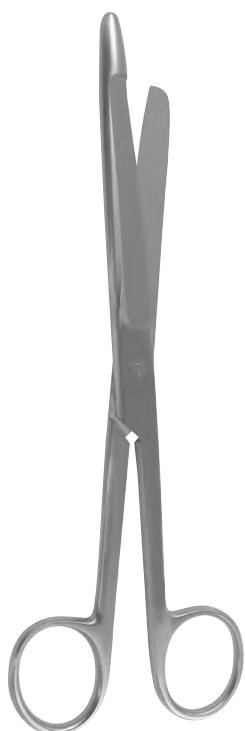

21,0 cm, 8¹/₄" **010-670-21**



21,0 cm, 8¹/₄" **010-672-21**



21,0 cm, 8¹/₄" **010-674-21**



LLOYD-DAVIES
27,0 cm, 10⁵/₈" **010-677-27**



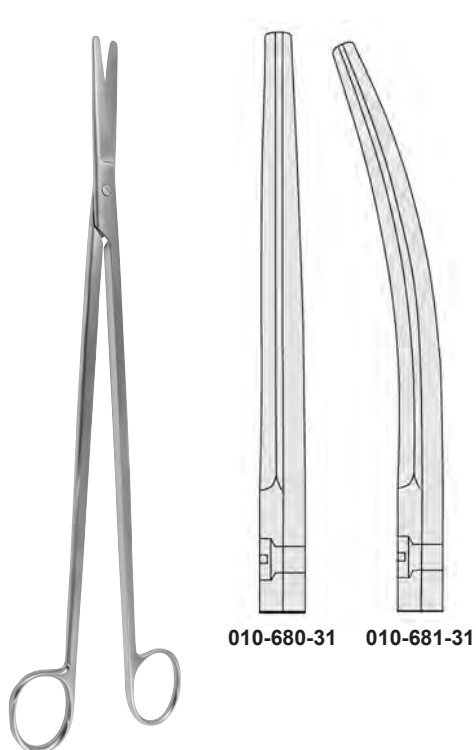

STELZNER
31,0 cm, 12¹/₄"

010-680-31 010-681-31

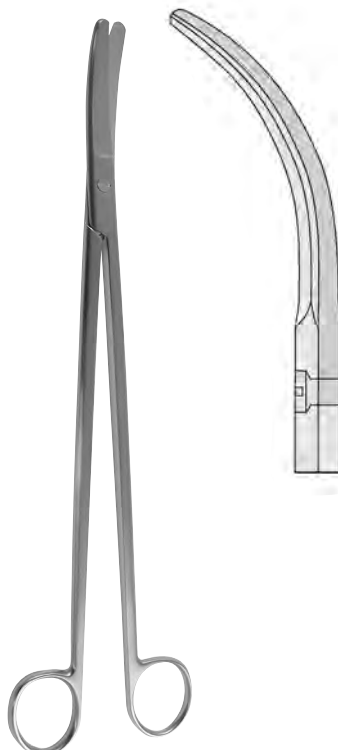

RECTAL
32,5 cm, 12³/₄"
010-685-32



WILLAUER
25,0 cm, 9³/₄" 010-688-25
28,0 cm, 11" 010-688-28

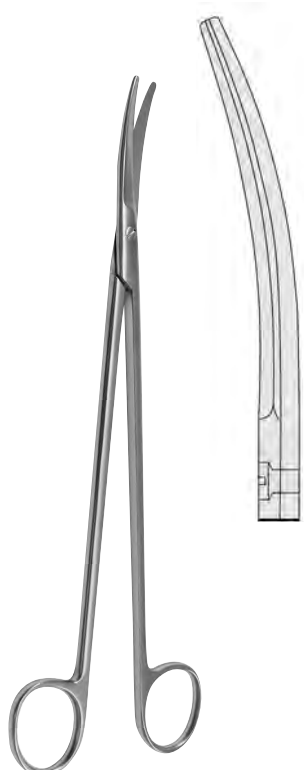

WILLAUER
25,0 cm, 9³/₄" 010-689-25
28,0 cm, 11" 010-689-28

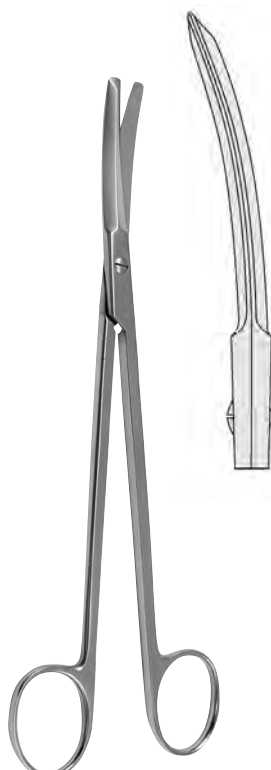

POTTS-SMITH
19,0 cm, 7¹/₂"
010-691-19



FINOCHIETTO
32,5 cm, 10⁵/₈"
010-693-27



WALDMANN
18,0 cm, 7"
010-695-18



BRAUN-STADLER
14,5 cm, 5³/₄" 010-701-14
20,0 cm, 8" 010-701-20



20,0 cm, 8"
010-703-20



MOD. USA
10,5 cm, 4¹/₈"
010-706-10



BUSCH
13,5 cm, 5³/₈" 010-707-13
16,0 cm, 6¹/₄" 010-707-16



SCHUMACHER
16,0 cm, 16¹/₄"
010-709-16



gezahnt
serrated
dentada
dentata

UNIVERSAL
12,0 cm, 4³/₄"
010-800-12



LISTER

9,0 cm, 3 ¹ / ₂ "	010-900-09
11,0 cm, 4 ³ / ₈ "	010-900-11
14,0 cm, 5 ¹ / ₂ "	010-900-14
18,0 cm, 7"	010-900-18
20,0 cm, 8"	010-900-20



LISTER

18,5 cm, 7 ¹ / ₄ "	010-901-18
21,0 cm, 8 ¹ / ₄ "	010-901-21

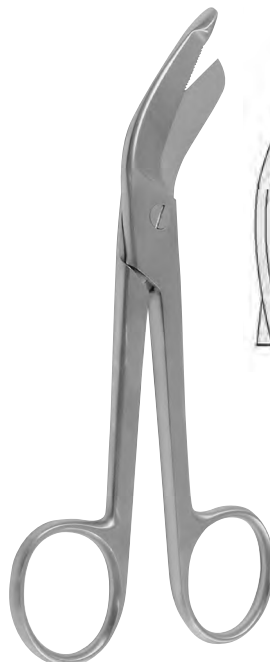

LISTER-EXCENTRIC

16,0 cm, 6 ¹ / ₄ "	010-903-16
19,0 cm, 7 ¹ / ₂ "	010-903-19



gezahnt
serrated
dentada
dentata

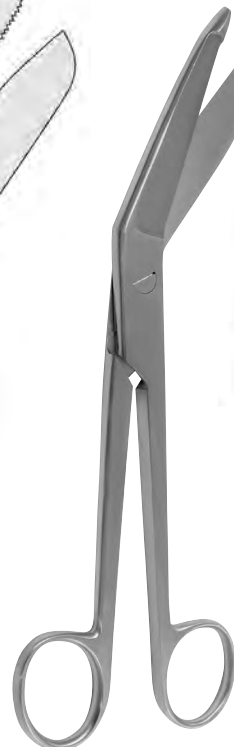

BERGMANN

23,0 cm, 9"	010-905-23
-------------	-------------------





ESMARCH
 20,0 cm, 8" **010-907-20**
 22,0 cm, 8⁵/₈" **010-907-22**



KNOWLES
 14,0 cm, 5¹/₂"
010-920-14

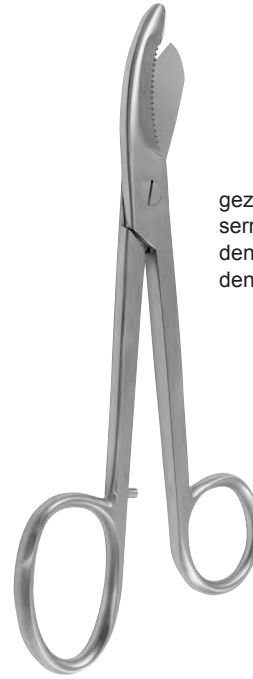

gezahnt
 serrated
 dentada
 dentata

BRUNS
 24,0 cm, 9¹/₂"
010-909-24
010-910-24

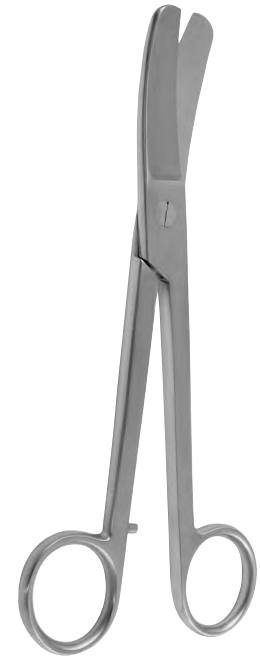

LORENZ
 23,0 cm, 9"
010-930-23

bis 134°C autoklavierbar
 autoclavable up to 134°C
 esterilizable en autoclave hasta 134°C
 Sterilizzabile in autoclave fino 134°C

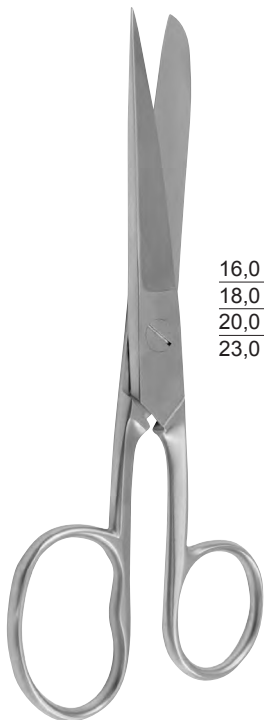

SMITH
 (MOD. USA)

16,0 cm, 6¹/₄" **010-940-16**
 18,0 cm, 7" **010-940-18**
 20,0 cm, 8" **010-940-20**
 23,0 cm, 9" **010-940-23**



gezahnt
 serrated
 dentada
 dentata

20,0 cm, 8"
010-941-20



gezahnt
 serrated
 dentada
 dentata

UNIVERSAL
 14,0 cm, 5¹/₂" **010-950-14**
 16,0 cm, 6¹/₄" **010-950-16**
 18,0 cm, 7" **010-950-18**

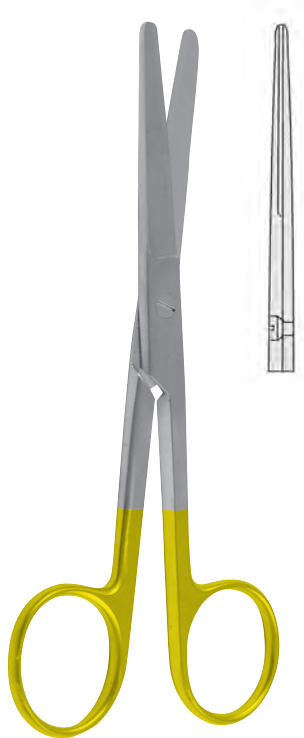

STANDARD

14,5 cm, 5 ³ / ₄ "	011-000-14
16,5 cm, 6 ¹ / ₂ "	011-000-16
18,5 cm, 7 ¹ / ₄ "	011-000-18

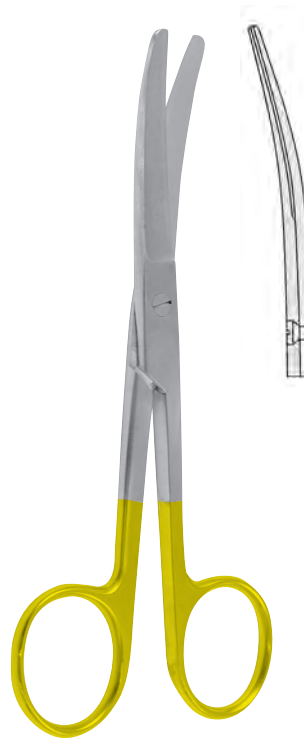

STANDARD

14,5 cm, 5 ³ / ₄ "	011-001-14
16,5 cm, 6 ¹ / ₂ "	011-001-16
18,5 cm, 7 ¹ / ₄ "	011-001-18

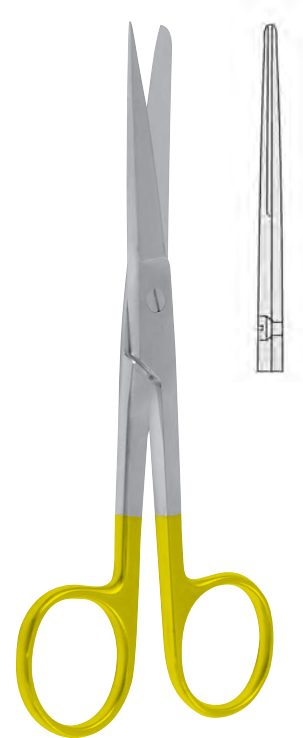

STANDARD

14,5 cm, 5 ³ / ₄ "	011-002-14
16,5 cm, 6 ¹ / ₂ "	011-002-16
18,5 cm, 7 ¹ / ₄ "	011-002-18

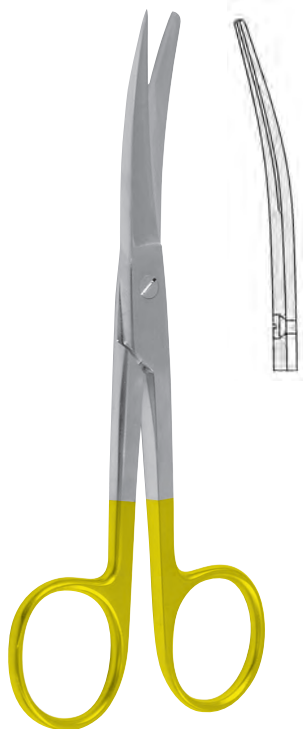

STANDARD

14,5 cm, 5 ³ / ₄ "	011-003-14
16,5 cm, 6 ¹ / ₂ "	011-003-16
18,5 cm, 7 ¹ / ₄ "	011-003-18

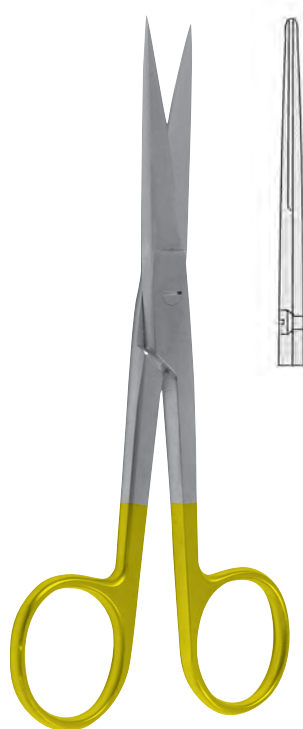

STANDARD

14,5 cm, 5 ³ / ₄ "	011-004-14
16,5 cm, 6 ¹ / ₂ "	011-004-16
18,5 cm, 7 ¹ / ₄ "	011-004-18

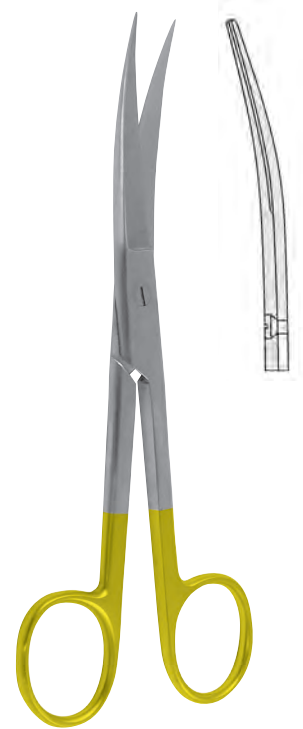

STANDARD

14,5 cm, 5 ³ / ₄ "	011-005-14
16,5 cm, 6 ¹ / ₂ "	011-005-16
18,5 cm, 7 ¹ / ₄ "	011-005-18

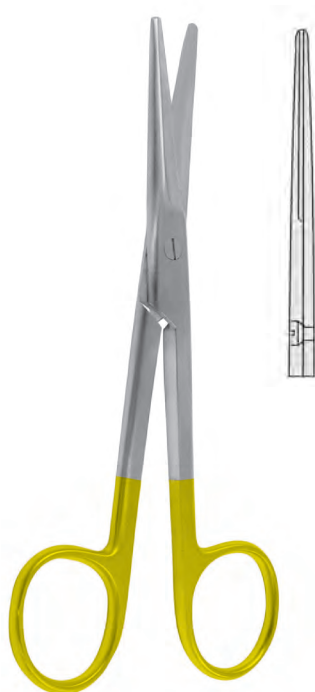

MAYO

14,5 cm, 5 ³ / ₄ "	011-100-14
17,0 cm, 6 ³ / ₄ "	011-100-17
23,0 cm, 9"	011-100-23



MAYO

14,5 cm, 5 ³ / ₄ "	011-101-14
17,0 cm, 6 ³ / ₄ "	011-101-17
23,0 cm, 9"	011-101-23

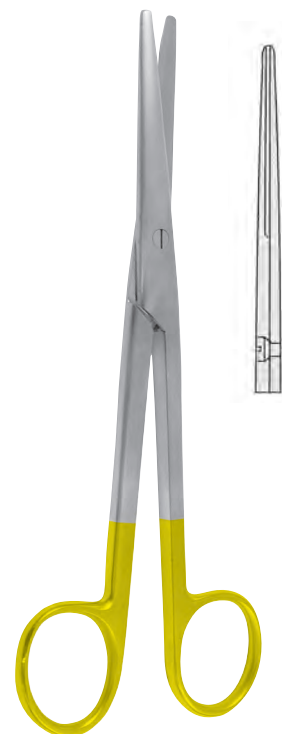

MAYO-STILLE

15,0 cm, 6"	011-102-15
17,0 cm, 6 ³ / ₄ "	011-102-17

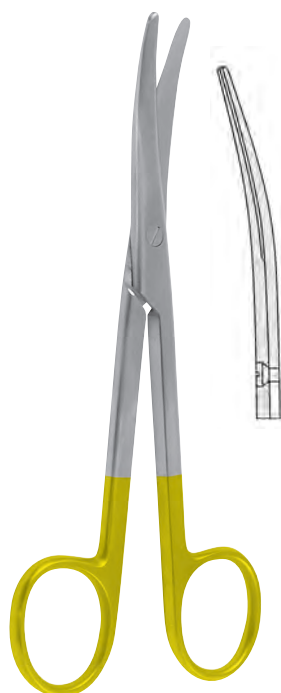

MAYO-STILLE

15,0 cm, 6"	011-103-15
17,0 cm, 6 ³ / ₄ "	011-103-17

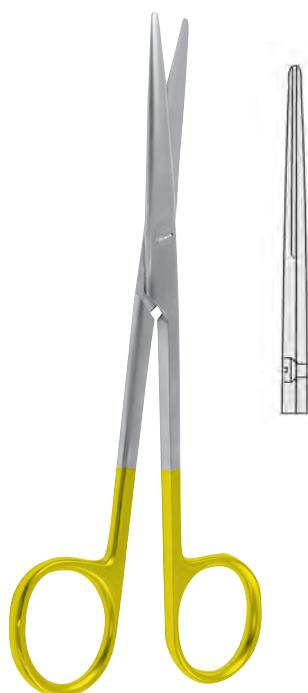

LEXER

16,0 cm, 6 ¹ / ₄ "	011-140-16
21,0 cm, 8 ¹ / ₄ "	011-140-21

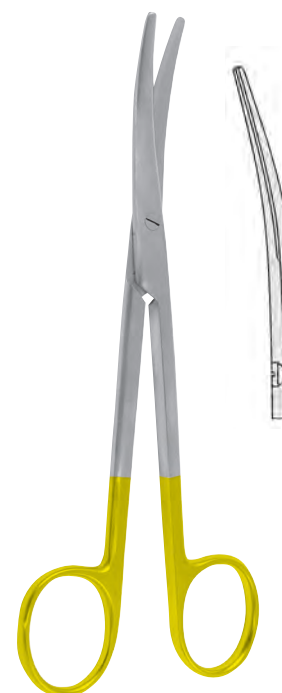

LEXER

16,0 cm, 6 ¹ / ₄ "	011-141-16
21,0 cm, 8 ¹ / ₄ "	011-141-21

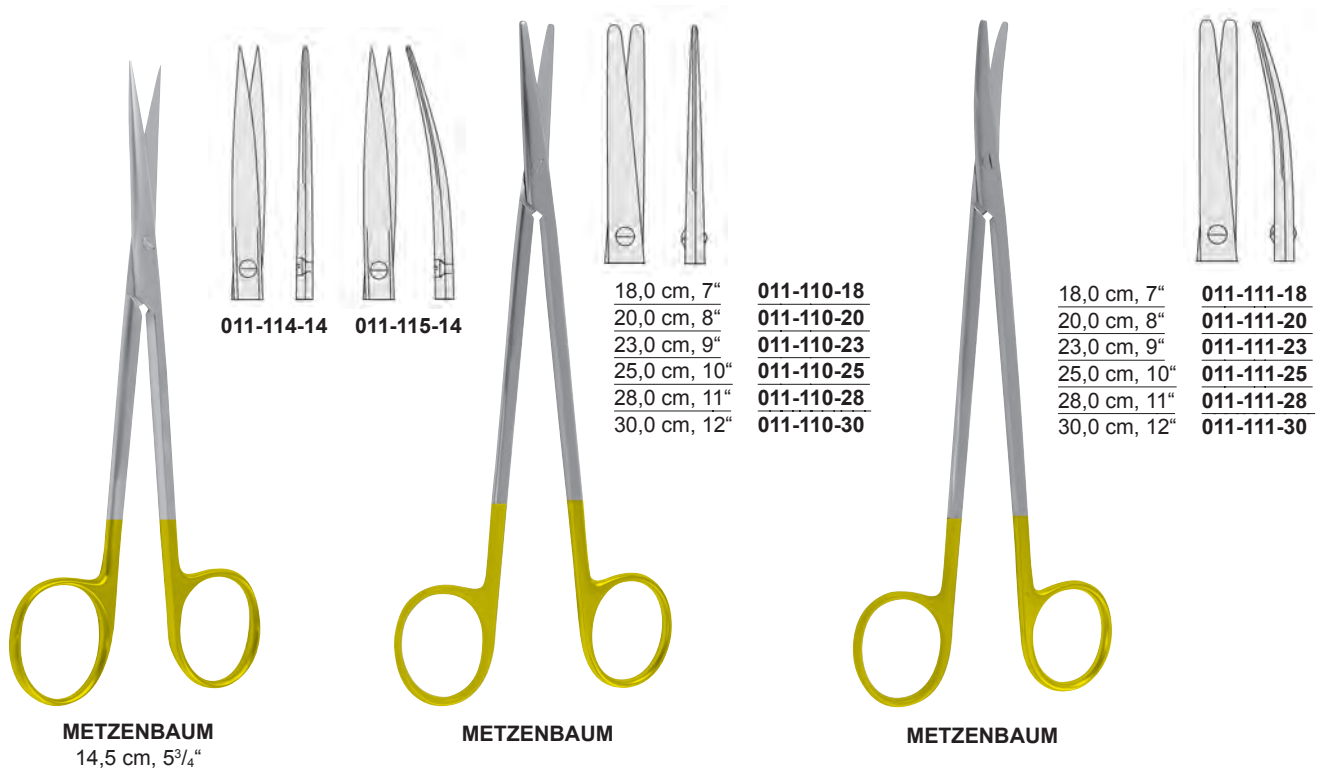
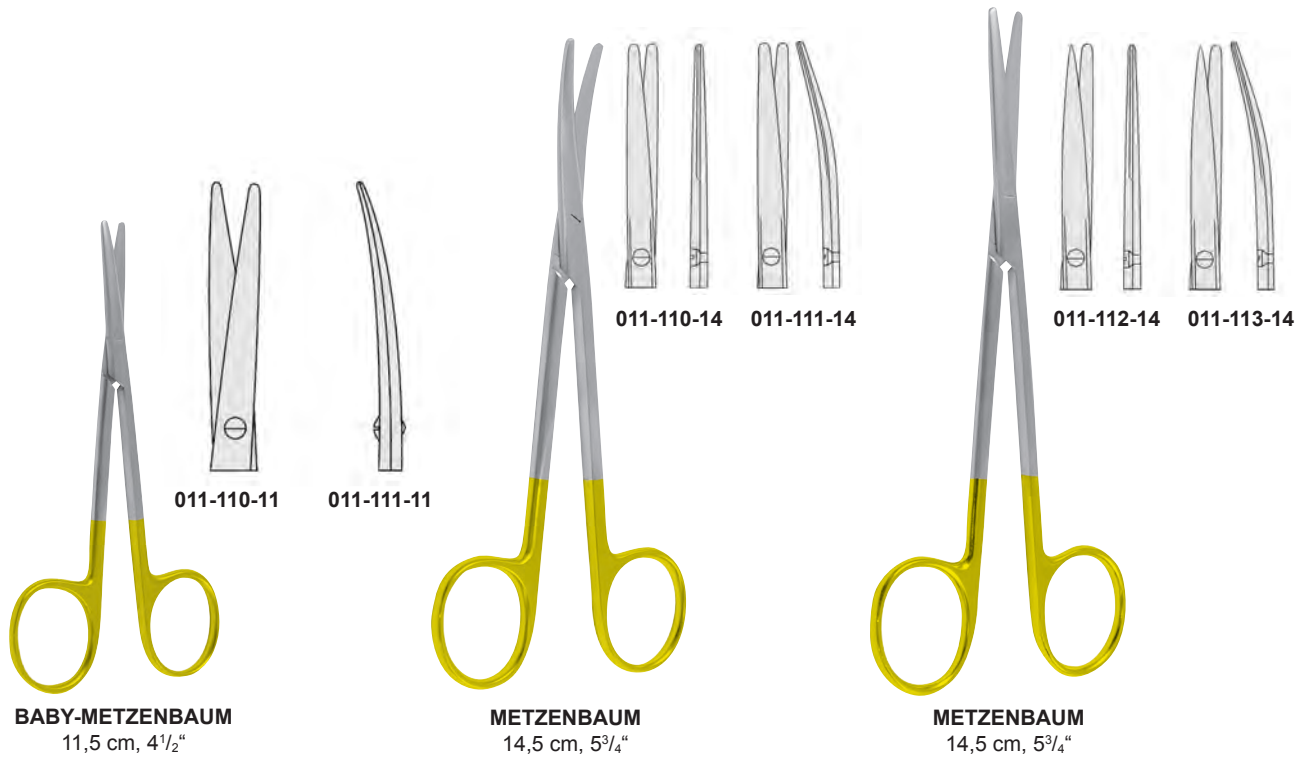

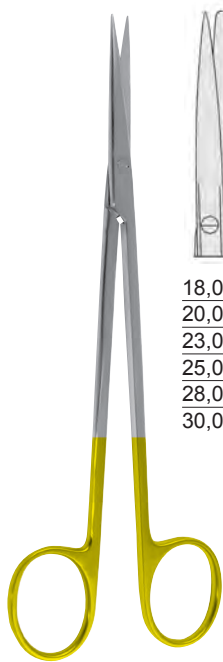

METZENBAUM

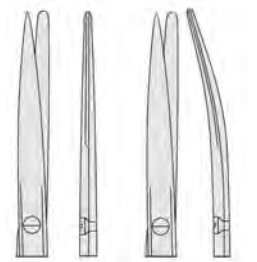

- 18,0 cm, 7" **011-112-18**
- 20,0 cm, 8" **011-112-20**
- 23,0 cm, 9" **011-112-23**
- 25,0 cm, 10" **011-112-25**
- 28,0 cm, 11" **011-112-28**
- 30,0 cm, 12" **011-112-30**

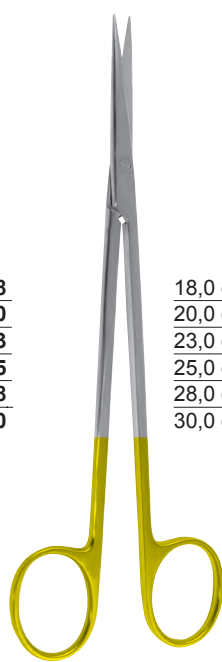

METZENBAUM

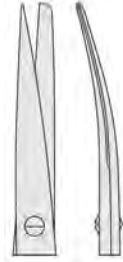

- 18,0 cm, 7" **011-113-18**
- 20,0 cm, 8" **011-113-20**
- 23,0 cm, 9" **011-113-23**
- 25,0 cm, 10" **011-113-25**
- 28,0 cm, 11" **011-113-28**
- 30,0 cm, 12" **011-113-30**

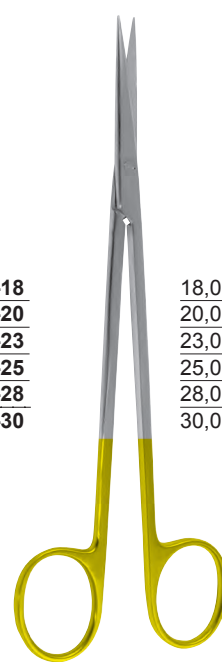

METZENBAUM

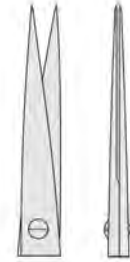

- 18,0 cm, 7" **011-114-18**
- 20,0 cm, 8" **011-114-20**
- 23,0 cm, 9" **011-114-23**
- 25,0 cm, 10" **011-114-25**
- 28,0 cm, 11" **011-114-28**
- 30,0 cm, 12" **011-114-30**

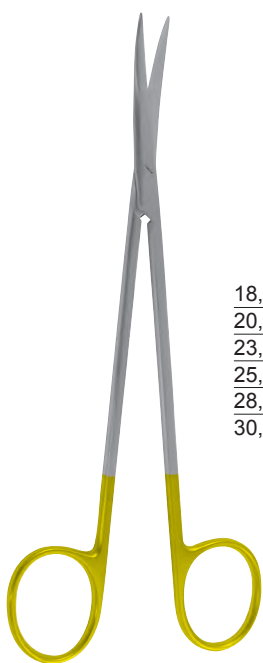

METZENBAUM

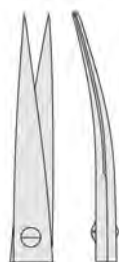

- 18,0 cm, 7" **011-115-18**
- 20,0 cm, 8" **011-115-20**
- 23,0 cm, 9" **011-115-23**
- 25,0 cm, 10" **011-115-25**
- 28,0 cm, 11" **011-115-28**
- 30,0 cm, 12" **011-115-30**

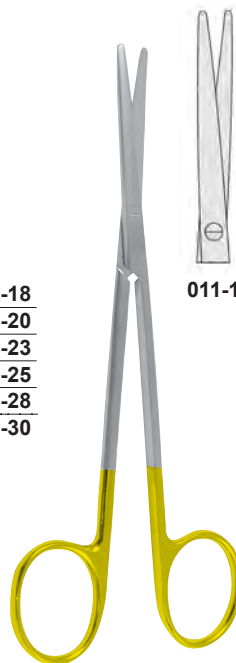

METZENBAUM-FINO
14,5 cm, 5³/₄"

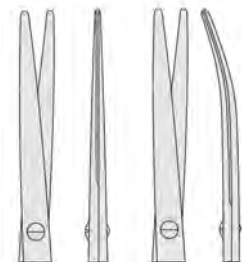

- 011-120-14**
- 011-121-14**

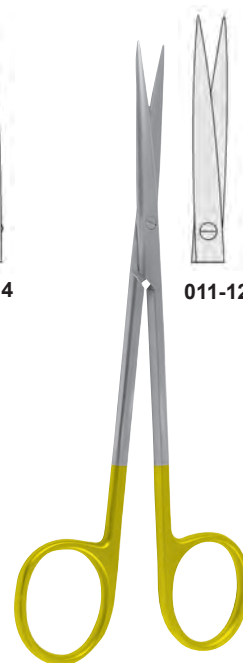

METZENBAUM-FINO
14,5 cm, 5³/₄"

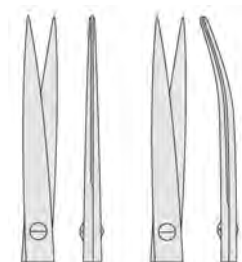

- 011-124-14**
- 011-125-14**

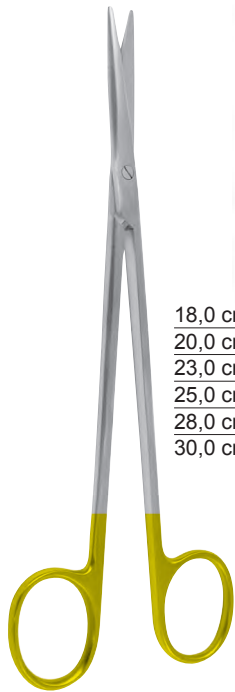

18,0 cm, 7"	011-120-18
20,0 cm, 8"	011-120-20
23,0 cm, 9"	011-120-23
25,0 cm, 10"	011-120-25
28,0 cm, 11"	011-120-28
30,0 cm, 12"	011-120-30

METZENBAUM-FINO

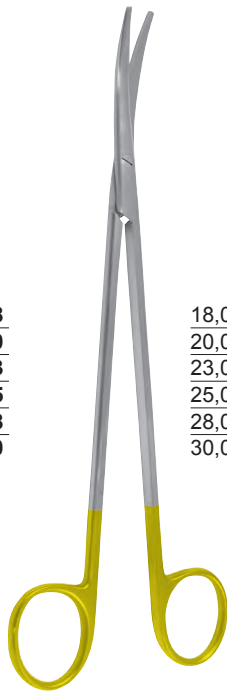

18,0 cm, 7"	011-121-18
20,0 cm, 8"	011-121-20
23,0 cm, 9"	011-121-23
25,0 cm, 10"	011-121-25
28,0 cm, 11"	011-121-28
30,0 cm, 12"	011-121-30

METZENBAUM-FINO

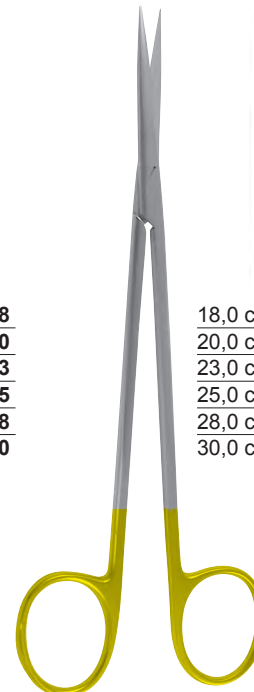

18,0 cm, 7"	011-124-18
20,0 cm, 8"	011-124-20
23,0 cm, 9"	011-124-23
25,0 cm, 10"	011-124-25
28,0 cm, 11"	011-124-28
30,0 cm, 12"	011-124-30

METZENBAUM-FINO

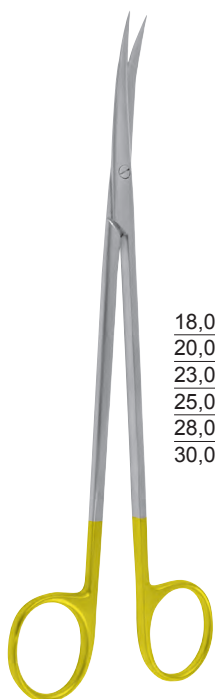

18,0 cm, 7"	011-125-18
20,0 cm, 8"	011-125-20
23,0 cm, 9"	011-125-23
25,0 cm, 10"	011-125-25
28,0 cm, 11"	011-125-28
30,0 cm, 12"	011-125-30

METZENBAUM-FINO

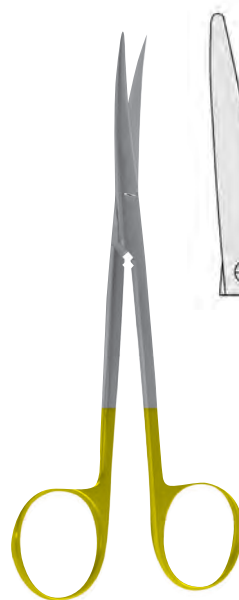

METZENBAUM-LAHEY
14,0 cm, 5 1/2"
011-137-14

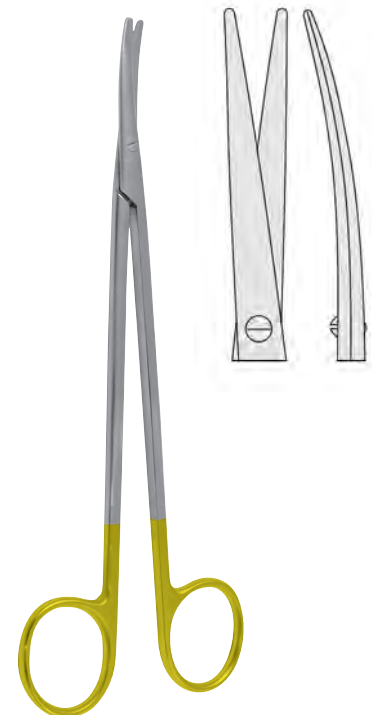

TOENNIS-ADSON
17,0 cm, 6 3/4"
011-139-17

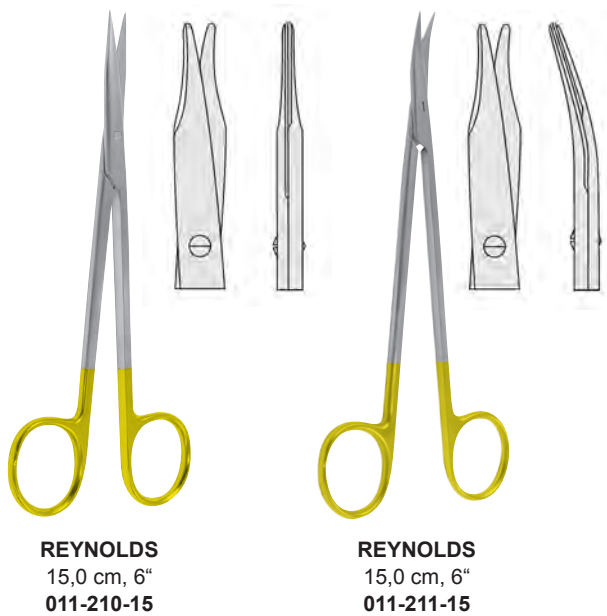
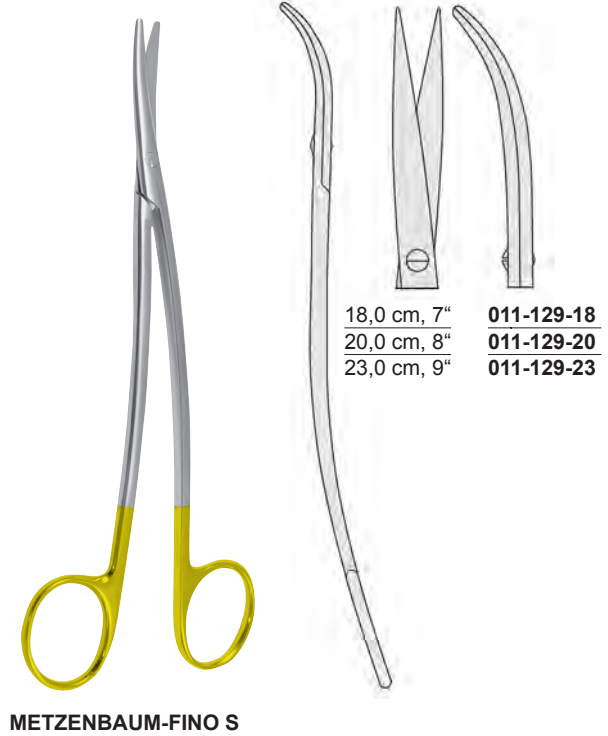



SIMS

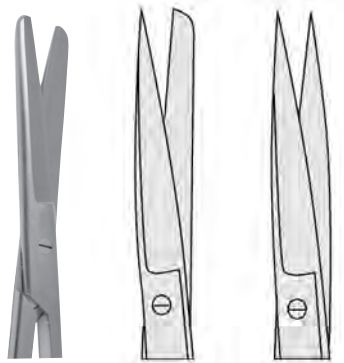

20,0 cm, 8"	011-600-20	011-602-20	011-604-20
23,0 cm, 9"	011-600-23	011-602-23	011-604-23



SIMS

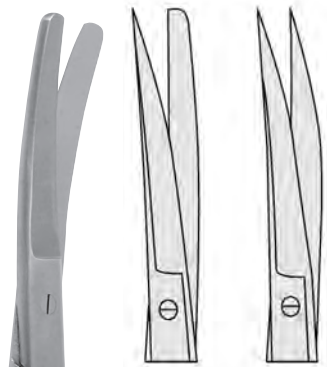

20,0 cm, 8"	011-601-20	011-603-20	011-605-20
23,0 cm, 9"	011-601-23	011-603-23	011-605-23

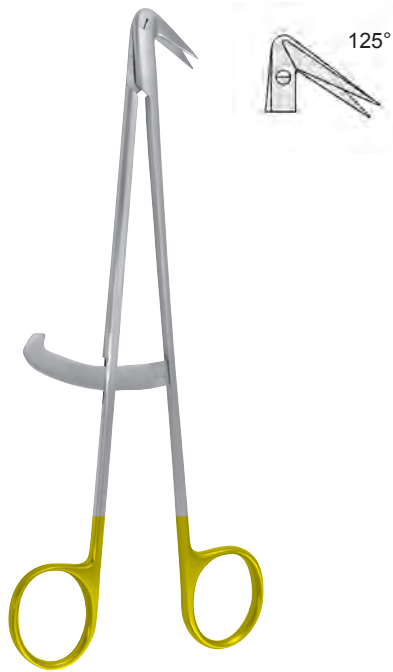

DIETRICH
17,5 cm, 6⁵/₈"
011-552-17



POTTS DE MARTEL
24,0 cm, 9¹/₂"
011-548-24

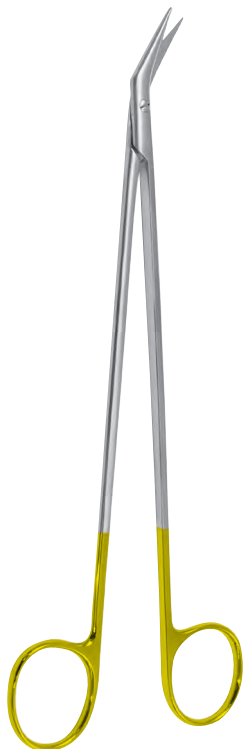

DE BAKEY

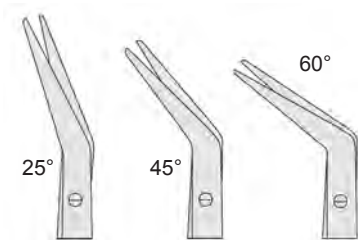

20,0 cm, 8"	011-543-25	011-543-45	011-543-60
23,0 cm, 9"	011-545-25	011-545-45	011-545-60

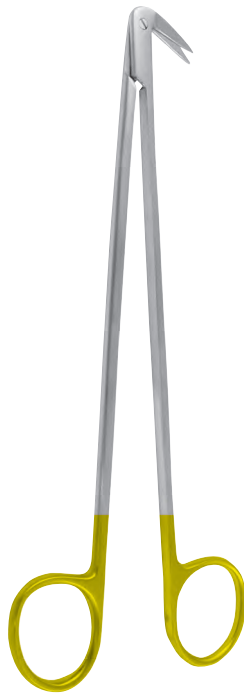

DIETHRICH-HEGEMANN
18,0 cm, 7"

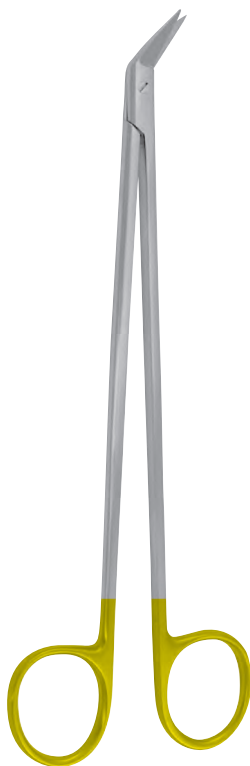

POTTS-SMITH
18,0 cm, 7 1/2"

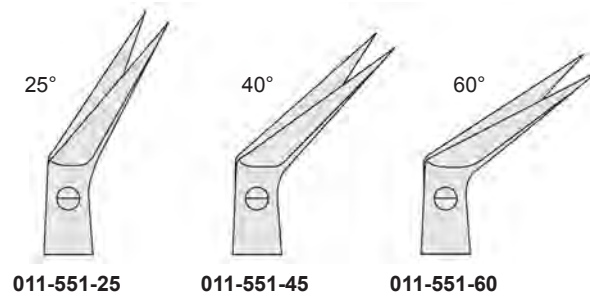



011-244-11 011-245-11

IRIS
11,5 cm, 4 1/2"



gezahnt
serrated
dentada
dentata

UNIVERSAL
12,0 cm, 4 3/4"
011-800-12

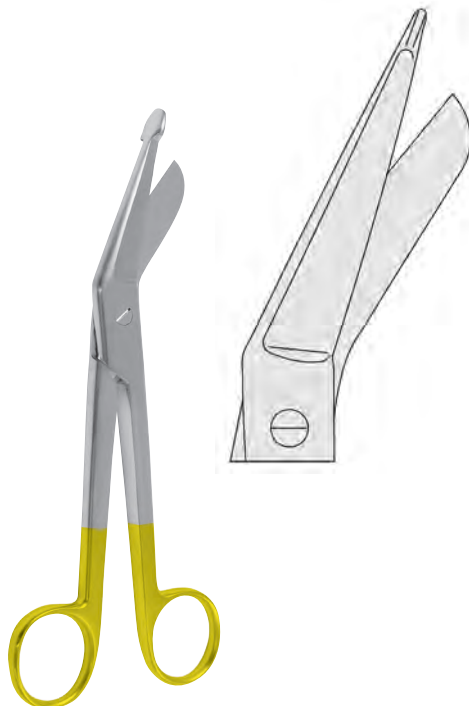

LISTER
18,0 cm, 7"
011-900-18

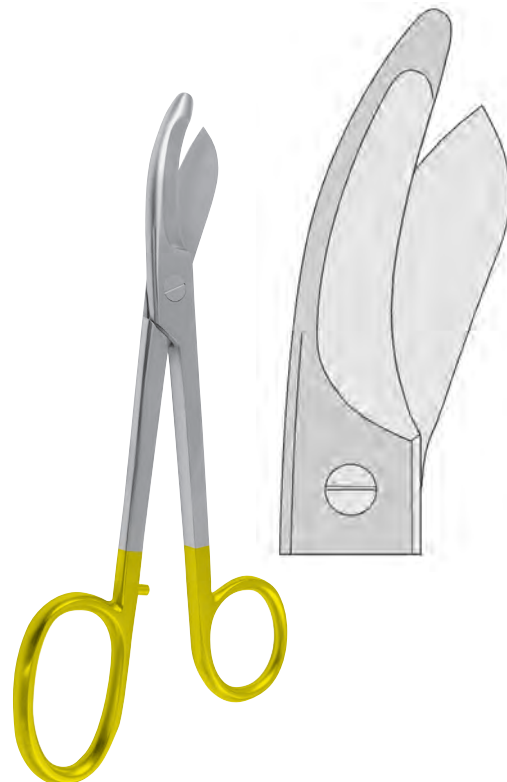

BRUNS
24,0 cm, 9 1/2"
011-909-24

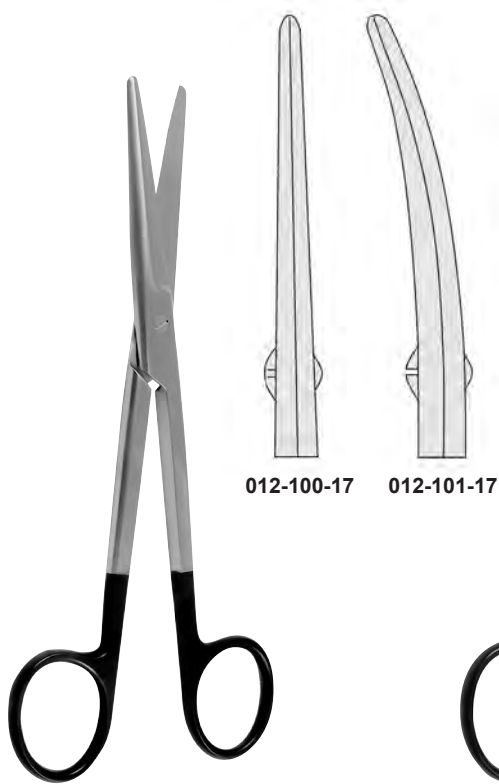

MAYO
17,0 cm, 6³/₄"

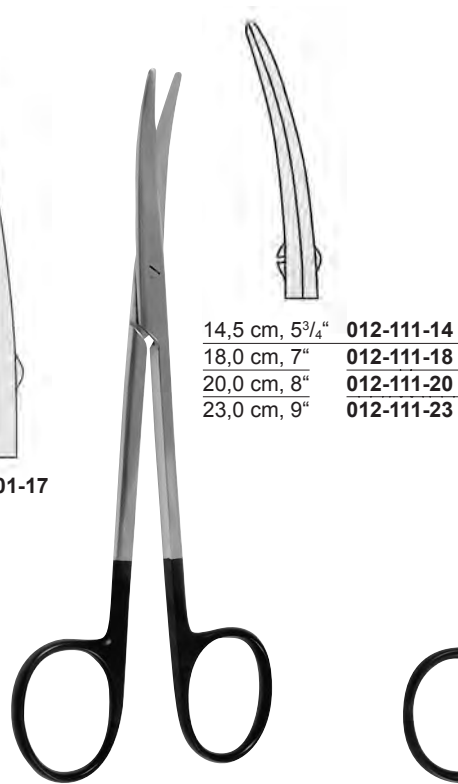

METZENBAUM

- | | |
|--|-------------------|
| 14,5 cm, 5 ³ / ₄ " | 012-111-14 |
| 18,0 cm, 7" | 012-111-18 |
| 20,0 cm, 8" | 012-111-20 |
| 23,0 cm, 9" | 012-111-23 |

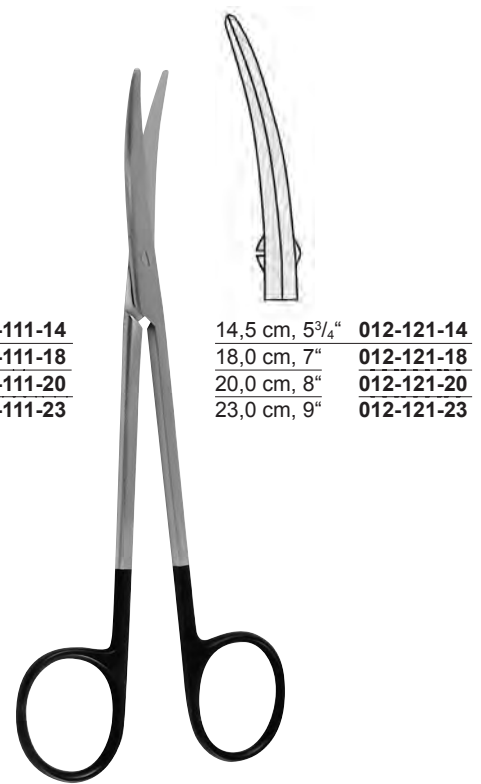

METZENBAUM-FINO

- | | |
|--|-------------------|
| 14,5 cm, 5 ³ / ₄ " | 012-121-14 |
| 18,0 cm, 7" | 012-121-18 |
| 20,0 cm, 8" | 012-121-20 |
| 23,0 cm, 9" | 012-121-23 |

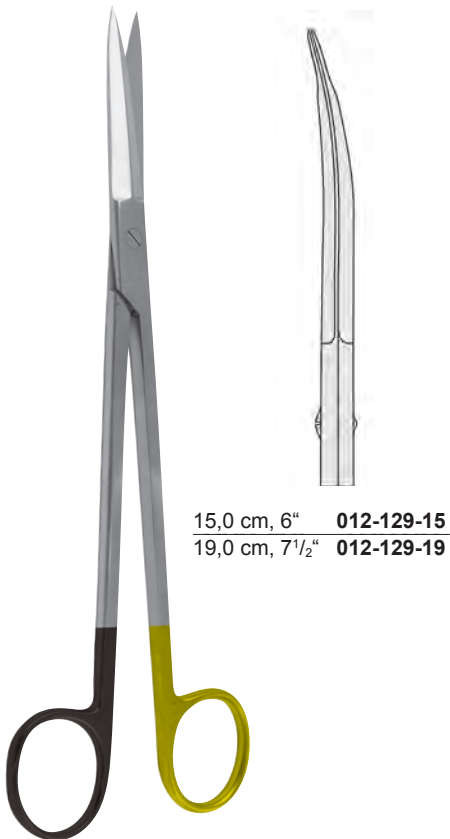

KAYE FACE LIFT

- | | |
|--|-------------------|
| 15,0 cm, 6" | 012-129-15 |
| 19,0 cm, 7 ¹ / ₂ " | 012-129-19 |

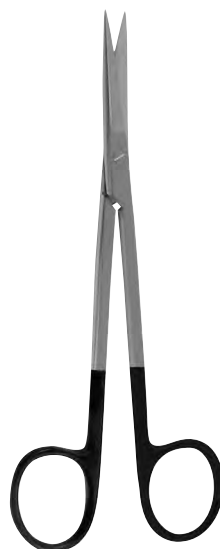

JABALEY
13,0 cm, 5"
012-130-13



TOENNIS-ADSON
17,0 cm, 6³/₄"
012-139-17

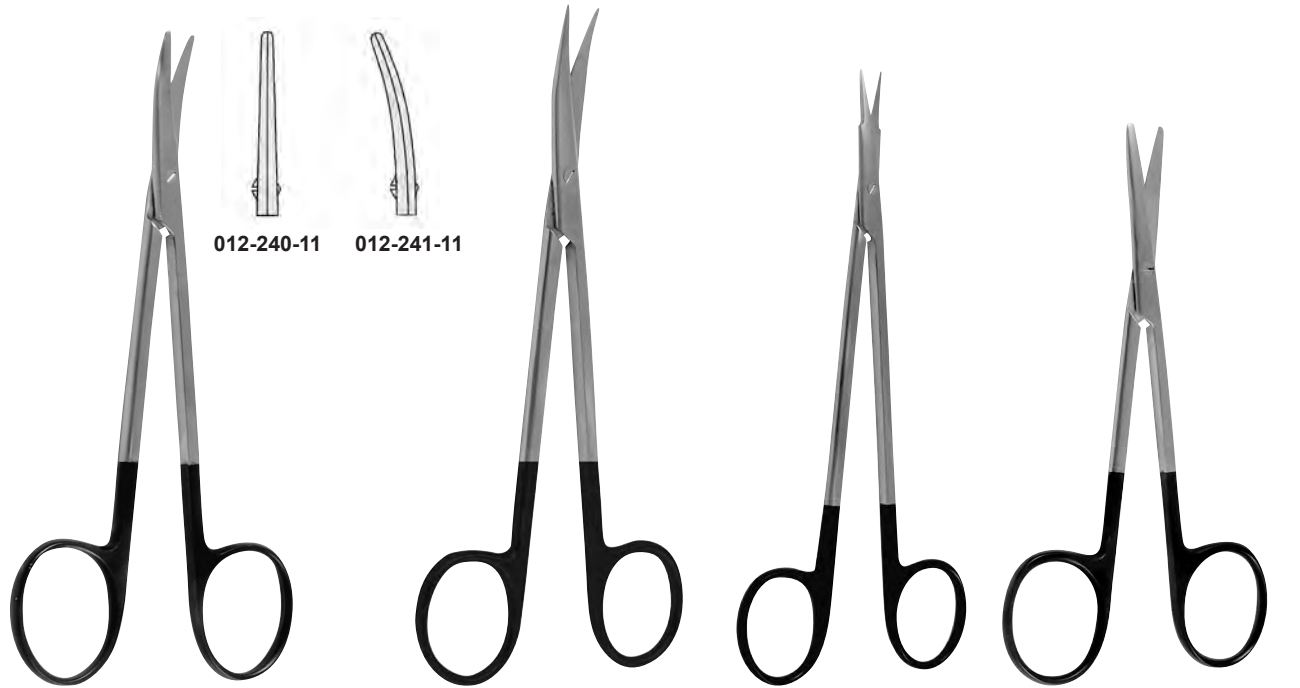

STRABISMUS
11,5 cm, 4 $\frac{1}{2}$ "

JAMISON
15,0 cm, 6" **012-218-15**
18,0 cm, 7" **012-218-18**

REYNOLDS
12,5 cm, 5"
012-210-12

BABY-METZENBAUM
11,0 cm, 4 $\frac{3}{8}$ " **012-110-11**
14,5 cm, 5 $\frac{3}{4}$ " **012-110-14**



IRIS
11,0 cm, 4 $\frac{3}{8}$ "
012-244-11



IRIS
11,0 cm, 4 $\frac{3}{8}$ "
012-245-11

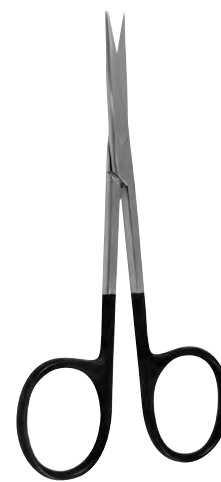

STEVENS TENOTOMY
11,0 cm, 4 $\frac{3}{8}$ "
012-290-11



STEVENS T ENOTOMY
11,0 cm, 4 $\frac{3}{8}$ "
012-291-11



gerade
straight

PAR TYPE
12,0 cm, 4³/₄"
012-200-12

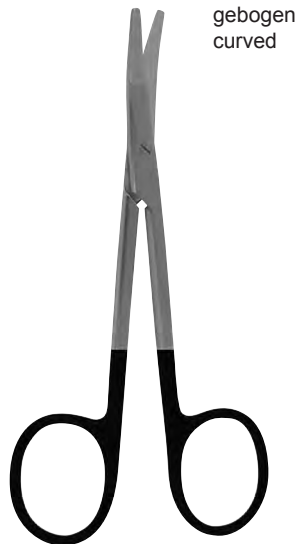

gebogen
curved

PAR TYPE
12,0 cm, 4³/₄"
012-201-12

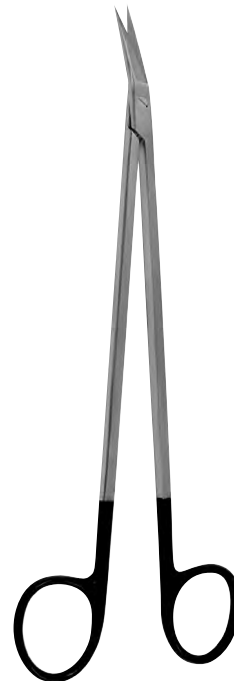

POTTS
19,0 cm, 7¹/₂"



012-551-25



012-551-45



012-551-60



FOMON
14,5 cm, 5³/₄"
012-343-15



COTTLE
16,5 cm, 6¹/₂"
012-511-16

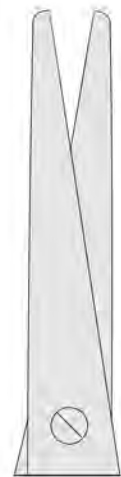



018-081-11

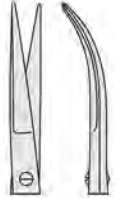

018-083-11

WESTCOTT
11,0 cm, 4³/₈"



gezahnt
serrated
dentada
dentata

GOMEL

14,0 cm, 5¹/₂" **018-241-14Z**
16,0 cm, 6¹/₄" **018-241-16Z**

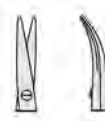

Mikro-Präparierscheren
Micro-dissecting scissors
Micro-tijeras de disección
Micro-forbici per dissezione

HEPP SCHEIDEL

14,0 cm, 5¹/₂" **018-243-14**
16,0 cm, 6¹/₄" **018-243-16**

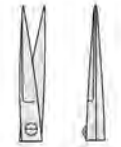
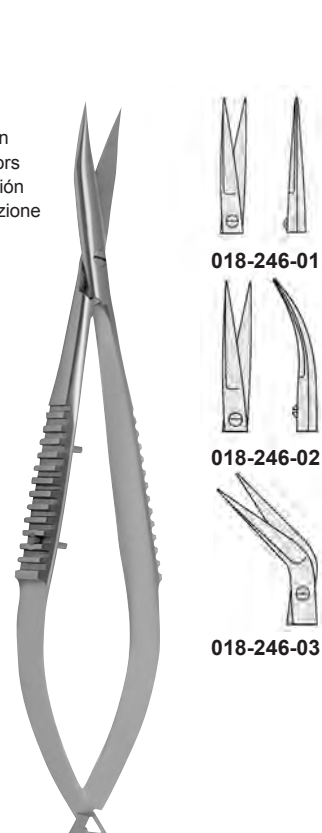

018-246-01

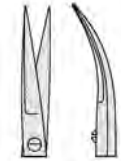

018-246-02



018-246-03

18,5 cm, 7¹/₄"



STEVENS



18,5 cm, 7¹/₄" **018-290-01** **018-290-02** **018-290-03** **018-290-04**
22,5 cm, 8³/₄" **018-291-01** **018-291-02** **018-291-03** **018-291-04**



18,5 cm, 7¹/₄" **018-292-01** **018-292-02**
22,5 cm, 8³/₄" **018-293-01** **018-293-02**



18,0 cm, 7"

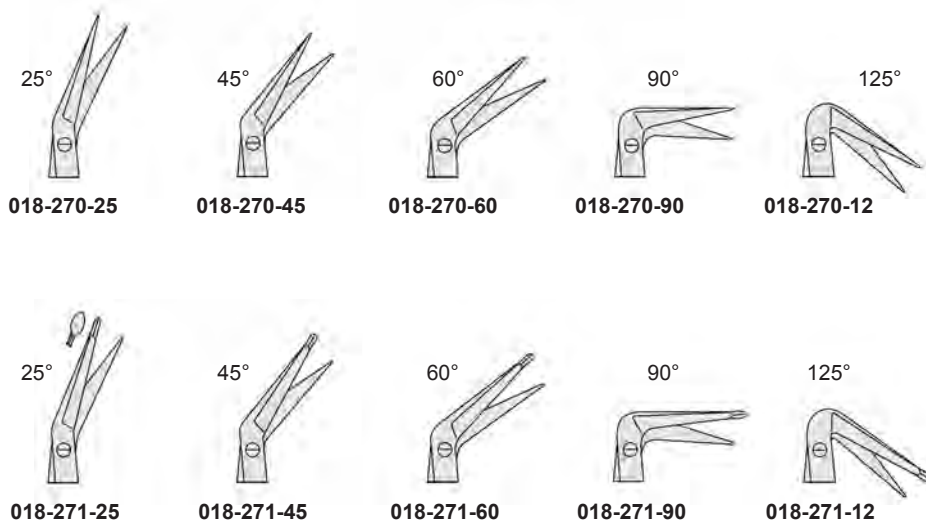

15,0 cm, 6"
018-223-15



15,0 cm, 6"
018-223-15Z

gezahnt
serrated
dentada
dentata



15,0 cm, 6"
018-201-15



18,0 cm, 7"
018-201-18



15,0 cm, 6"
018-232-15



15,0 cm, 6"
018-232-15Z



gezahnt
serrated
dentada
dentata

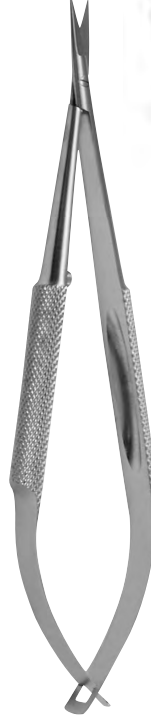

15,0 cm, 6"
018-203-15



18,0 cm, 7"
018-203-18



Forceps



STANDARD

10,5 cm, 4 ¹ / ₈ "	020-002-10
11,5 cm, 4 ¹ / ₂ "	020-002-11
13,0 cm, 5"	020-002-13
14,5 cm, 5 ³ / ₄ "	020-002-14
15,0 cm, 6"	020-002-15
16,0 cm, 6 ¹ / ₄ "	020-002-16
18,0 cm, 7"	020-002-18
20,0 cm, 8"	020-002-20
25,0 cm, 10"	020-002-25
30,0 cm, 12"	020-002-30



schmal
narrow
estrechos
stretti

STANDARD

10,5 cm, 4 ¹ / ₈ "	020-003-10
11,5 cm, 4 ¹ / ₂ "	020-003-11
13,0 cm, 5"	020-003-13
14,5 cm, 5 ³ / ₄ "	020-003-14
15,0 cm, 6"	020-003-15
16,0 cm, 6 ¹ / ₄ "	020-003-16
18,0 cm, 7"	020-003-18
20,0 cm, 8"	020-003-20
25,0 cm, 10"	020-003-25
30,0 cm, 12"	020-003-30

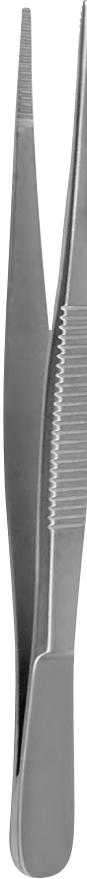

schmal
narrow
estrechos
stretti

STANDARD

10,5 cm, 4 ¹ / ₈ "	020-004-10
11,5 cm, 4 ¹ / ₂ "	020-004-11
13,0 cm, 5"	020-004-13
14,5 cm, 5 ³ / ₄ "	020-004-14
15,0 cm, 6"	020-004-15
16,0 cm, 6 ¹ / ₄ "	020-004-16
18,0 cm, 7"	020-004-18
20,0 cm, 8"	020-004-20
25,0 cm, 10"	020-004-25
30,0 cm, 12"	020-004-30



fein
fine
finas
fini

STANDARD

10,5 cm, 4 ¹ / ₈ "	020-010-10
11,5 cm, 4 ¹ / ₂ "	020-010-11
13,0 cm, 5"	020-010-13
14,5 cm, 5 ³ / ₄ "	020-010-14
15,0 cm, 6"	020-010-15
16,0 cm, 6 ¹ / ₄ "	020-010-16
18,0 cm, 7"	020-010-18
20,0 cm, 8"	020-010-20
25,0 cm, 10"	020-010-25
30,0 cm, 12"	020-010-30



fein
fine
finas
fini
тонкие

10,5 cm, 4 ¹ / ₈ "	020-011-10
11,5 cm, 4 ¹ / ₂ "	020-011-11
13,0 cm, 5"	020-011-13
14,5 cm, 5 ³ / ₄ "	020-011-14
16,0 cm, 6 ¹ / ₄ "	020-011-16
18,0 cm, 7"	020-011-18
20,0 cm, 8"	020-011-20
25,0 cm, 10"	020-011-25
30,0 cm, 12"	020-011-30



fein
fine
finas
fini

mit Stift
with pin
con perno
con espiga

10,5 cm, 4 ¹ / ₈ "	020-018-10
11,5 cm, 4 ¹ / ₂ "	020-018-11
13,0 cm, 5"	020-018-13
14,5 cm, 5 ³ / ₄ "	020-018-14
16,0 cm, 6 ¹ / ₄ "	020-018-16
18,0 cm, 7"	020-018-18
20,0 cm, 8"	020-018-20
25,0 cm, 10"	020-018-25
30,0 cm, 12"	020-018-30



MOD. USA

12,0 cm, 4 ³ / ₄ "	020-006-10
13,0 cm, 5"	020-006-13
14,5 cm, 5 ³ / ₄ "	020-006-14
15,0 cm, 6"	020-006-15
18,0 cm, 7"	020-006-18
20,0 cm, 8"	020-006-20
25,5 cm, 10"	020-006-25
30,0 cm, 12"	020-006-30



schmal
narrow
estrechos
stretti
узкие

MOD. USA

12,0 cm, 4 ³ / ₄ "	020-012-11
13,0 cm, 5"	020-012-13
14,5 cm, 5 ³ / ₄ "	020-012-14
15,0 cm, 6"	020-012-15
18,0 cm, 7"	020-012-18
20,0 cm, 8"	020-012-20
25,5 cm, 10"	020-012-25



ADSON
 12,0 cm, 4³/₄" **020-070-12**
 15,0 cm, 6" **020-070-15**



MICRO-ADSON
 12,0 cm, 4³/₄" **020-076-12**
 15,0 cm, 6" **020-076-15**



STILLE
 15,0 cm, 6"
020-008-15



MC INDOE
 15,0 cm, 6"
020-158-15



TAYLOR
 17,5 cm, 6⁵/₈"
020-114-17



TAYLOR
 17,5 cm, 6⁵/₈"
020-115-17



TAYLOR
 18,5 cm, 7¹/₄"
020-117-18



GERALD
 18,0 cm, 7"
020-102-18



GERALD
18,0 cm, 7"
020-103-18



POTTS-SMITH
18,0 cm, 7" **020-026-18**
21,0 cm, 8¹/₄" **020-026-21**
25,0 cm, 10" **020-026-25**



POTTS-SMITH
18,0 cm, 7" **020-027-18**
21,0 cm, 8¹/₄" **020-027-21**
25,0 cm, 10" **020-027-25**



SEMKEN
12,5 cm, 5" **020-040-12**
15,0 cm, 6" **020-040-15**



CUSHING
17,5 cm, 6⁵/₈"
020-092-17



CUSHING
17,5 cm, 6⁵/₈"
020-093-17



BROPHY
20,0 cm, 8"
020-094-20



BROPHY
20,0 cm, 8"
020-095-20



BONNEY
18,0 cm, 7"
020-120-18



SINGLE-TUTTLE
23,0 cm, 9"
020-516-23



DENNIS BROWN
20,0 cm, 8"
020-126-20



DUEHRSEN
20,0 cm, 8"
020-470-20



WAUGH
15,0 cm, 6" **020-130-15**
20,0 cm, 8" **020-130-20**



RAMSEY
18,0 cm, 7"
020-136-18

 1 x 2



 2 x 3



 3 x 4



 4 x 5



STANDARD	
10,5 cm, 4 ¹ / ₈ "	020-200-10
11,5 cm, 4 ¹ / ₂ "	020-200-11
13,0 cm, 5"	020-200-13
14,5 cm, 5 ³ / ₄ "	020-200-14
15,0 cm, 6"	020-200-15
16,0 cm, 6 ¹ / ₄ "	020-200-16
18,0 cm, 7"	020-200-18
20,0 cm, 8"	020-200-20
25,0 cm, 10"	020-200-25
30,0 cm, 12"	020-200-30

11,5 cm, 4 ¹ / ₂ "	020-252-11
13,0 cm, 5"	020-252-13
14,5 cm, 5 ³ / ₄ "	020-252-14
16,0 cm, 6 ¹ / ₄ "	020-252-16
18,0 cm, 7"	020-252-18
20,0 cm, 8"	020-252-20
25,0 cm, 10"	020-252-25
30,0 cm, 12"	020-252-30

13,0 cm, 5"	020-254-13
14,5 cm, 5 ³ / ₄ "	020-254-14
16,0 cm, 6 ¹ / ₄ "	020-254-16
18,0 cm, 7"	020-254-18
20,0 cm, 8"	020-254-20

13,0 cm, 5"	020-256-13
14,5 cm, 5 ³ / ₄ "	020-256-14
16,0 cm, 6 ¹ / ₄ "	020-256-16
18,0 cm, 7"	020-256-18
20,0 cm, 8"	020-256-20

fein
fine
finas
fini

mit Stift
with pin
con perno
con espiga

mit Stift
with pin
con perno
con espiga

englische Modelle
english patterns
modelos ingleses
modell inglese

↔ 1 x 2

1 x 2

1 x 2

1 x 2



13,0 cm, 5"	020-210-13
14,5 cm, 5 ³ / ₄ "	020-210-14
15,5 cm, 6"	020-210-15
16,0 cm, 6 ¹ / ₄ "	020-210-16
18,0 cm, 7"	020-210-18
20,0 cm, 8"	020-210-20
25,0 cm, 10"	020-210-25
30,0 cm, 12"	020-210-30

13,0 cm, 5"	020-218-13
14,5 cm, 5 ³ / ₄ "	020-218-14
15,5 cm, 6"	020-218-15
16,0 cm, 6 ¹ / ₄ "	020-218-16
18,0 cm, 7"	020-218-18
20,0 cm, 8"	020-218-20
25,0 cm, 10"	020-218-25
30,0 cm, 12"	020-218-30

13,0 cm, 5"	020-219-13
14,5 cm, 5 ³ / ₄ "	020-219-14
16,0 cm, 6 ¹ / ₄ "	020-219-16
18,0 cm, 7"	020-219-18
20,0 cm, 8"	020-219-20

13,0 cm, 5"	020-236-13
14,5 cm, 5 ³ / ₄ "	020-236-14
15,0 cm, 6"	020-236-15



MOD. USA	
12,0 cm, 4 ³ / ₄ "	020-206-12
13,0 cm, 5"	020-206-13
14,5 cm, 5 ³ / ₄ "	020-206-14
15,5 cm, 6"	020-206-15
18,0 cm, 7"	020-206-18
20,0 cm, 8"	020-206-20
25,0 cm, 10"	020-206-25
30,0 cm, 12"	020-206-30



MOD. USA	
12,0 cm, 4 ³ / ₄ "	020-212-12
13,0 cm, 5"	020-212-13
14,5 cm, 5 ³ / ₄ "	020-212-14
15,5 cm, 6"	020-212-15
18,0 cm, 7"	020-212-18
20,0 cm, 8"	020-212-20
25,0 cm, 10"	020-212-25
30,0 cm, 12"	020-212-30

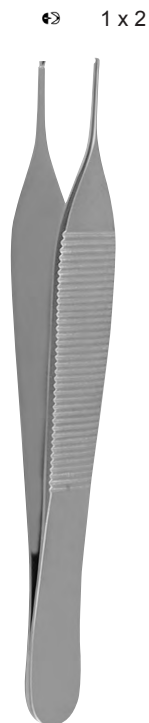

ADSON	
12,0 cm, 4 ³ / ₄ "	020-270-12
15,0 cm, 6"	020-270-15



MICRO-ADSON	
12,0 cm, 4 ³ / ₄ "	020-276-12
15,0 cm, 6"	020-276-15

 2 x 3



ADSON

12,0 cm, 4³/₄" **020-074-12**
15,0 cm, 6" **020-074-15**

 7 x 7



ADSON-BROWN

12,0 cm, 4³/₄" **020-288-12**
15,0 cm, 6" **020-288-15**

 1 x 2



ADSON

12,0 cm, 4³/₄"
020-282-12

 1 x 2



STILLE

15,0 cm, 6"
020-208-15

 2 x 3



STILLE

15,0 cm, 6"
020-209-15

 1 x 2



GILLIES

15,0 cm, 6"
020-300-15

 2 x 3



ADLERKREUTZ

15,0 cm, 6" **020-382-15**
20,0 cm, 8" **020-382-20**

 4 x 5



ADLERKREUTZ

15,0 cm, 6" **020-384-15**
20,0 cm, 8" **020-384-20**

↔ 1 x 2



SEMKEN
12,5 cm, 5" **020-240-12**
15,5 cm, 6" **020-240-15**

↔ 2 x 3



SEMKEN
12,5 cm, 5" **020-242-12**

↔ 1 x 2



MC INDOE
15,0 cm, 6" **020-358-15**

↔ 1 x 2



TAYLOR
17,5 cm, 6⁵/₈" **020-314-17**

↔ 1 x 2



TAYLOR
17,5 cm, 6⁵/₈" **020-315-17**

↔ 1 x 2



TAYLOR
17,5 cm, 6⁵/₈" **020-317-17**

↔ 1 x 2



GERALD
18,0 cm, 7" **020-302-18**

↔ 1 x 2



GERALD
18,0 cm, 7" **020-303-18**

 1 x 2



CUSHING
17,5 cm, 6⁵/₈"
020-292-17

 1 x 2



CUSHING
17,5 cm, 6⁵/₈"
020-293-17

 1 x 2



POTTS-SMITH
18,0 cm, 7" 020-226-18
21,0 cm, 8¹/₄" 020-226-21
25,0 cm, 10" 020-226-25

 1 x 2



WAUGH
15,0 cm, 6" 020-330-15
20,0 cm, 8" 020-330-20

 1 x 2



BROPHY
20,0 cm, 8"
020-294-20



RUSS. MODELL
15,0 cm, 6" 020-456-15
20,0 cm, 8" 020-456-20
25,0 cm, 10" 020-456-25



DURANTE

14,5 cm, 5³/₄" **020-460-14**
 16,0 cm, 6¹/₄" **020-460-16**
 20,0 cm, 8" **020-460-20**



DUEHRSEN

20,0 cm, 8"

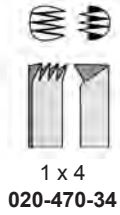

NELSON

15,0 cm, 6" **020-518-15**
 20,0 cm, 8" **020-518-20**
 23,0 cm, 9" **020-518-23**



DUVAL
 14,0 cm, 5¹/₂"



COLLIN-DUVAL
 20,0 cm, 8"

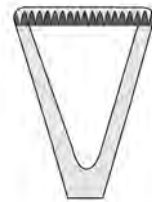

Tissue Forceps



7 x 7



LANE

14,5 cm, 5³/₄" **020-420-14**
20,0 cm, 8" **020-420-20**



LANE

14,5 cm, 5³/₄" **020-422-14**
20,0 cm, 8" **020-422-20**



BROWN

15,0 cm, 6" **020-410-15**
20,0 cm, 8" **020-410-20**
25,0 cm, 10" **020-410-25**

1 x 2



TREVES

13,0 cm, 5" **020-510-13**
15,0 cm, 6" **020-510-15**



RAMSEY
18,0 cm, 7" **020-520-18**



RAMSEY
18,0 cm, 7" **020-522-18**



RAMSEY
18,0 cm, 7" **020-590-18**



RAMSEY
18,0 cm, 7" **020-592-18**

mit Stift
with pin
con perno
con espiga

mit Stift
with pin
con perno
con espiga



8,0 cm, 3¹/₄" **020-662-08**
 9,0 cm, 3¹/₂" **020-662-09**
 10,5 cm, 4¹/₈" **020-662-10**
 11,5 cm, 4¹/₂" **020-662-11**
 13,0 cm, 5" **020-662-13**
 14,5 cm, 5¹/₂" **020-662-14**

8,0 cm, 3¹/₄" **020-663-08**
 9,0 cm, 3¹/₂" **020-663-09**
 10,5 cm, 4¹/₈" **020-663-10**
 11,5 cm, 4¹/₂" **020-663-11**
 13,0 cm, 5" **020-663-13**
 14,5 cm, 5¹/₂" **020-663-14**

8,0 cm, 3¹/₄" **020-666-08**
 9,0 cm, 3¹/₂" **020-666-09**
 10,5 cm, 4¹/₈" **020-666-10**
 11,5 cm, 4¹/₂" **020-666-11**
 13,0 cm, 5" **020-666-13**
 14,5 cm, 5¹/₂" **020-666-14**

8,0 cm, 3¹/₄" **020-667-08**
 9,0 cm, 3¹/₂" **020-667-09**
 10,5 cm, 4¹/₈" **020-667-10**
 11,5 cm, 4¹/₂" **020-667-11**
 13,0 cm, 5" **020-667-13**
 14,5 cm, 5¹/₂" **020-667-14**



HUNTER
10,5 cm, 4¹/₄"
020-652-10



HUNTER
10,5 cm, 4¹/₄"
020-653-10



WALTER-CARMALT
10,5 cm, 4¹/₄"
020-656-10



WALTER-CARMALT
10,5 cm, 4¹/₄"
020-657-10



FEILCHENFELD
7,5 cm, 3¹/₈" 020-650-07
9,0 cm, 3¹/₂" 020-650-09
11,5 cm, 4¹/₂" 020-650-11



10,0 cm, 4"
020-806-10



10,0 cm, 4"
020-807-10



GRAEFE
10,0 cm, 4"
020-810-10



GRAEFE
10,0 cm, 4"
020-811-10



GRAEFE
10,0 cm, 4"
020-813-10



GRAEFE
10,0 cm, 4"
020-814-10



GRAEFE
10,0 cm, 4"
020-815-10



GRAEFE
10,0 cm, 4"
020-817-10



Fig. 3
11,5 cm, 4½"
020-601-03



Fig. 4
11,5 cm, 4½"
020-601-04



Fig. 5
11,5 cm, 4½"
020-601-05



Fig. 7
11,5 cm, 4½"
020-601-07

0,3 mm x 45°

0,3 mm x 90°

0,3 mm

0,3 mm x 45°



9 mm

11,0 cm, 4¾"
020-620-01



9 mm

11,0 cm, 4¾"
020-620-02



9 mm

11,0 cm, 4¾"
020-620-03



9 mm

11,0 cm, 4¾"
020-620-04

diamantbeschichtet
diamond coated
diamantado
diamantato



1,5 mm 2,0 mm 2,4 mm 2,8 mm



16,0 cm, 6 ¹ / ₄ "	020-700-16	020-702-16	020-704-16	020-706-16
20,0 cm, 8"	020-700-20	020-702-20	020-704-20	020-706-20
24,0 cm, 9 ¹ / ₂ "	020-700-24	020-702-24	020-704-24	020-706-24
30,0 cm, 12"	020-700-30	020-702-30	020-704-30	020-706-30

2,8 mm 3,5 mm 3,5 mm



16,0 cm, 6 ¹ / ₄ "	020-716-16	020-708-16	020-718-16
20,0 cm, 8"	020-716-20	020-708-20	020-718-20
24,0 cm, 9 ¹ / ₂ "	020-716-24	020-708-24	020-718-24
30,0 cm, 12"	020-716-30	020-708-30	020-718-30

DE BAKEY



1,5 mm 2,0 mm



16,0 cm, 6 ¹ / ₄ "	020-701-16	020-703-16
20,0 cm, 8"	020-701-20	020-703-20
24,0 cm, 9 ¹ / ₂ "	020-701-24	020-703-24
30,0 cm, 12"	020-701-30	020-703-30

DE BAKEY



STANDARD

14,5 cm, 5 ³ / ₄ "	021-200-14
16,0 cm, 6 ¹ / ₄ "	021-200-16
18,0 cm, 7"	021-200-18
20,0 cm, 8"	021-200-20
25,0 cm, 10"	021-200-25
30,0 cm, 12"	021-200-30



STANDARD

14,0 cm, 5 ¹ / ₂ "	021-208-14
16,0 cm, 6 ¹ / ₄ "	021-208-16
18,0 cm, 7"	021-208-18
20,0 cm, 8"	021-208-20
25,0 cm, 10"	021-208-25
30,0 cm, 12"	021-208-30



STANDARD

12,5 cm, 5"	021-040-12
15,0 cm, 6"	021-040-15



STANDARD

15,0 cm, 6"	021-140-15
23,0 cm, 9"	021-140-23
25,0 cm, 10"	021-140-25



GILLIES
15,0 cm, 6"
021-300-15



MC INDOE
15,0 cm, 6"
021-158-15



GERALD
17,0 cm, 6³/₄"

021-102-17

021-302-17



POTTS-SMITH
15,0 cm, 6" 021-026-15
18,0 cm, 7" 021-026-18
20,0 cm, 8" 021-026-20



BONNEY
17,5 cm, 6⁵/₈"
021-590-17



CUSHING
17,5 cm, 6⁵/₈"



021-092-17



021-093-17



CUSHING-TAYLOR
18,0 cm, 7"
021-117-18



ADSON
17,5 cm, 6⁵/₈"



12,0 cm, 4³/₄"
021-070-12



12,0 cm, 4³/₄"
021-270-12

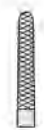

15,0 cm, 6"
021-070-15

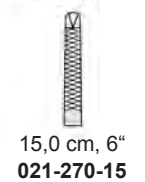

15,0 cm, 6"
021-270-15

Towel Clamps, Sponge and Dressing Forceps, Tubing Clamps



SCHAEDEL
9,0 cm, 3 1/2"
030-101-09



ENGL. MODELL
9,0 cm, 3 1/2"
030-109-09



JONES
5,0 cm, 2" 030-105-05
7,0 cm, 2 3/4" 030-105-07
9,0 cm, 3 1/2" 030-105-09



JONES
9,0 cm, 3 1/2"
030-107-09

mit Schlauch- oder Kabelhalter
with clip for tubing or cable
con porta-tubo o porta-cable
con porta-tubo o porta-cavo



BACKHAUS
9,0 cm, 3 1/2" 030-000-09
11,0 cm, 4 3/8" 030-000-11
13,0 cm, 5" 030-000-13
15,0 cm, 6" 030-000-15



11,0 cm, 4 3/8"
030-005-11



ROEDER
13,0 cm, 5"
030-010-13



ROEDER
15,0 cm, 5"
030-010-15



BERNHARD
16,5 cm, 6½"
030-044-16



Kugel / Pfanne
Ball / Socket
Bola / Cojinete
Palla / Cuscinetto

13,0 cm, 5"
030-024-13



10,0 cm, 4"
030-014-10

13,0 cm, 5"
030-014-13



LORNA



LANE

15,0 cm, 6"	030-040-15
18,0 cm, 7"	030-040-18
20,0 cm, 8"	030-040-20



TOHOKU

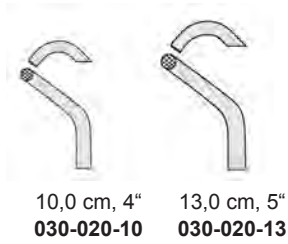

10,0 cm, 4"
030-020-10

13,0 cm, 5"
030-020-13



PEERS
14,5 cm, 5³/₄"
030-030-14



LISTER
13,0 cm, 5" **030-360-13**
16,0 cm, 6¹/₄" **030-360-16**
18,0 cm, 7" **030-360-18**



BRYANT
13,0 cm, 5"
030-351-13



BOZEMANN
26,0 cm, 10¹/₄"
030-320-26



BOZEMANN
26,0 cm, 10¹/₄"
030-321-26

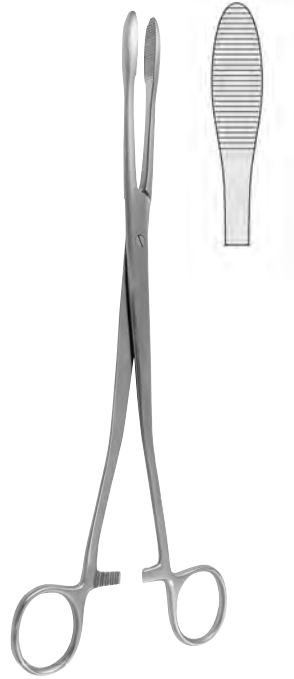

COLLIN
25,0 cm, 9³/₄"
030-300-25



CHERON
25,0 cm, 9³/₄"
030-303-25

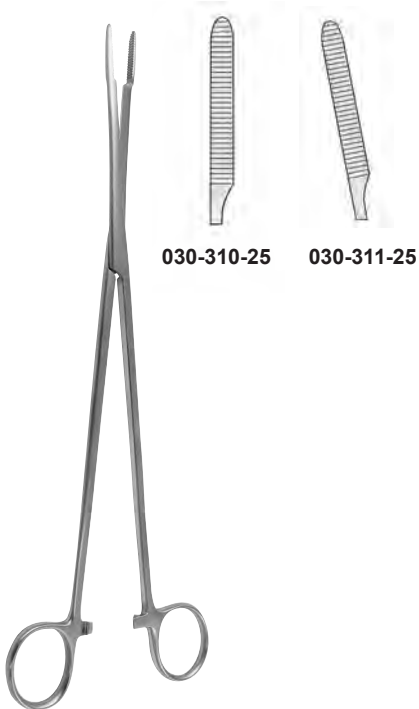

PELKMANN
25,0 cm, 9³/₄"



ULRICH

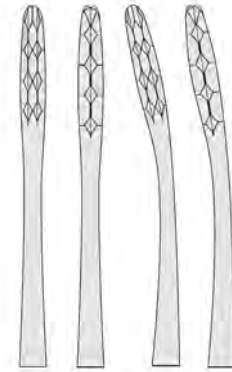

22,0 cm, 8⁵/₈" 030-200-22 030-201-22
25,0 cm, 9³/₄" 030-200-25 030-201-25
27,0 cm, 10⁵/₈" 030-200-27 030-201-27

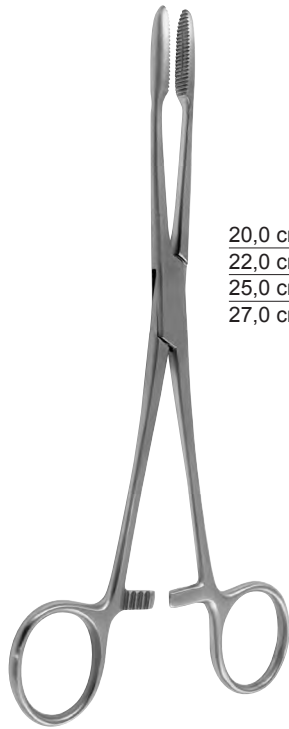

GROSS-MAIER

20,0 cm, 8"	030-210-20	030-211-20
22,0 cm, 8 ⁵ / ₈ "	030-210-22	030-211-22
25,0 cm, 9 ³ / ₄ "	030-210-25	030-211-25
27,0 cm, 10 ⁵ / ₈ "	030-210-27	030-211-27



FOERSTER

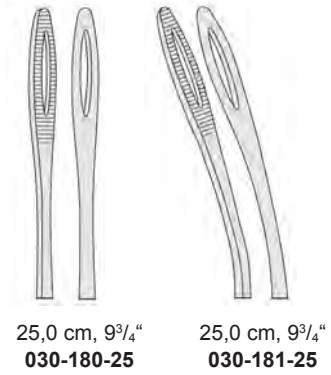

25,0 cm, 9³/₄"
030-180-25

25,0 cm, 9³/₄"
030-181-25



FOERSTER-BALLENGER

18,0 cm, 7"	030-160-18	030-161-18	030-170-18	030-171-18
20,0 cm, 8"	030-160-20	030-161-20	030-170-20	030-171-20
25,0 cm, 9 ³ / ₄ "	030-160-25	030-161-25	030-170-25	030-171-25

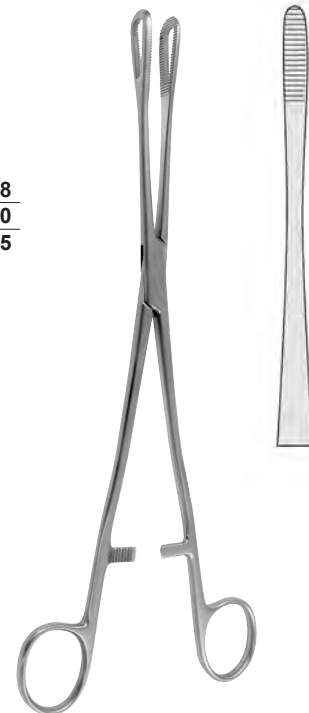

RAMPLEY

18,0 cm, 7"	030-190-18
25,0 cm, 9 ³ / ₄ "	030-190-25

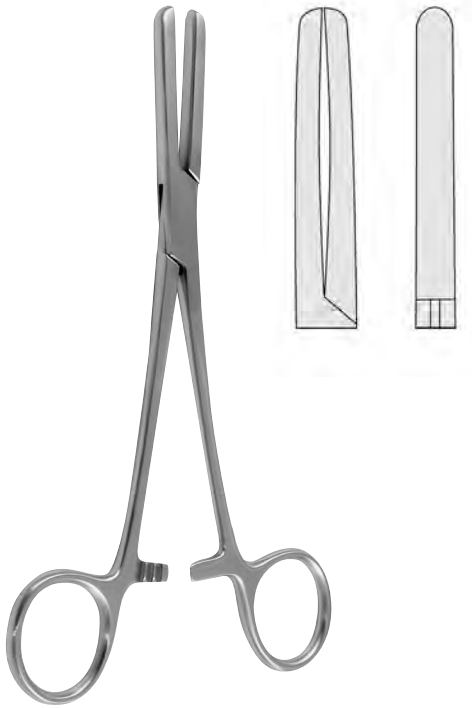

PRESBYTERIAN
 16,5 cm, 6½" **032-012-16**
 18,0 cm, 7" **032-012-18**
 20,0 cm, 8" **032-012-20**



BERLIN
 14,5 cm, 5¾" **032-006-14**

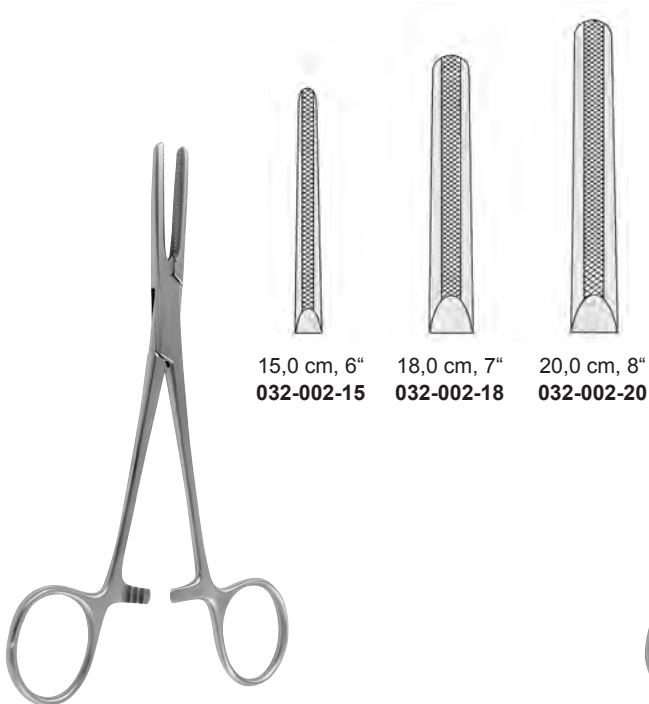

15,0 cm, 6" **032-002-15**
 18,0 cm, 7" **032-002-18**
 20,0 cm, 8" **032-002-20**

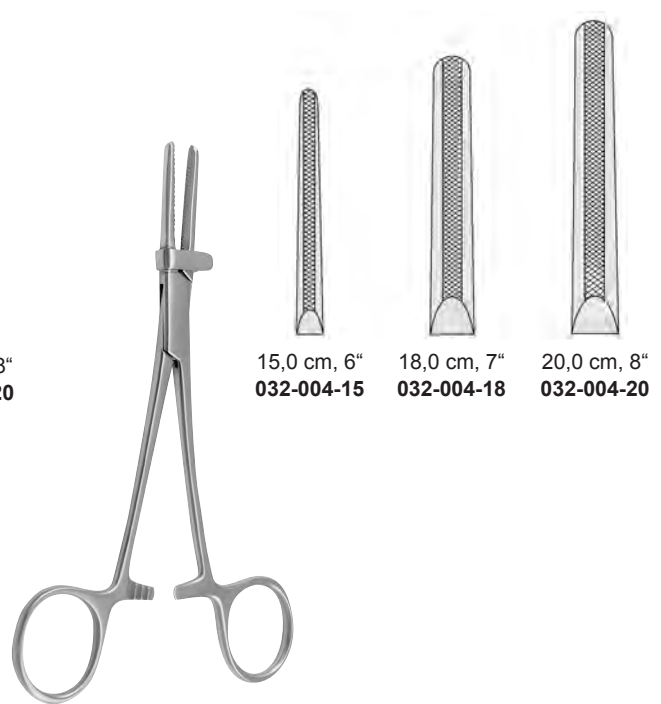

15,0 cm, 6" **032-004-15**
 18,0 cm, 7" **032-004-18**
 20,0 cm, 8" **032-004-20**

Forceps



3,5 cm, 1 1/2"	026-014-03	026-015-03
5,0 cm, 2"	026-014-05	026-015-05



DIEFFENBACH



HESS
026-520-01



HESS
026-520-02



3,8 cm, 1 1/2"	026-018-04	026-019-04
5,0 cm, 2"	026-018-05	026-019-05
6,3 cm, 2 1/2"	026-018-06	026-019-06
7,6 cm, 3"	026-018-07	026-019-07
9,0 cm, 3 1/2"	026-018-09	026-019-09

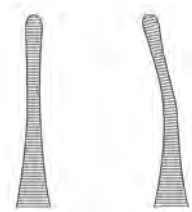

JOHNS-HOPKINS



JOHNS-HOPKINS
23,0 cm, 9"
026-295-23



mit atraumatischer Riefung
with non-traumatic serration
con bocas atraumáticas
con presa atraumatica
с атравматичной зазубреностью

		L	
7,5 cm, 3"	026-292-07	2,5 cm, 1"	
8,5 cm, 3 ¹ / ₄ "	026-292-08	3,5 cm, 1 ³ / ₈ "	
10,5 cm, 4 ¹ / ₈ "	026-292-10	5,0 cm, 2"	
12,0 cm, 4 ³ / ₄ "	026-292-12	6,8 cm, 2 ³ / ₄ "	

DE BAKEY

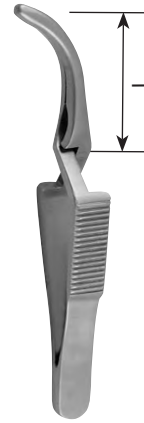

mit atraumatischer Riefung
with non-traumatic serration
con bocas atraumáticas
con presa atraumatica
с атравматичной зазубреностью

		L	
7,0 cm, 2 ³ / ₄ "	026-293-07	2,5 cm, 1"	
8,0 cm, 3 ¹ / ₈ "	026-293-08	3,5 cm, 1 ³ / ₈ "	
10,0 cm, 3 ³ / ₄ "	026-293-10	5,0 cm, 2"	
11,5 cm, 4 ¹ / ₂ "	026-293-12	6,8 cm, 2 ³ / ₄ "	

DE BAKEY



TITANIUM
3,5 cm, 1³/₈"
vena **027-032-35**
arteria **027-042-35**



TITANIUM
3,5 cm, 1³/₈"
vena **027-033-35**
arteria **027-043-35**

gerade
straight
recto
retto



TITANIUM
4,0 cm, 1⁵/₈"
vena **027-032-40**
arteria **027-042-40**

gebogen
curved
curvo
curvo



TITANIUM
4,0 cm, 1⁵/₈"
vena **027-033-40**
arteria **027-043-40**

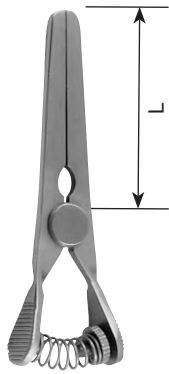

		L	
6,8 cm, 2 ³ / ₄ "	026-298-07	3,3 cm, 1 ³ / ₈ "	
9,6 cm, 3 ³ / ₄ "	026-298-09	5,0 cm, 2"	
11,7 cm, 4 ³ / ₄ "	026-298-11	6,9 cm, 2 ³ / ₄ "	

GLOVER

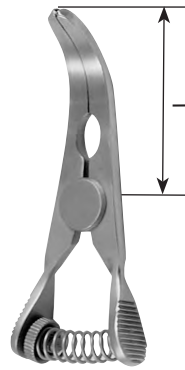

		L	
6,5 cm, 2 ¹ / ₂ "	026-299-06	3,3 cm, 1 ³ / ₈ "	
9,1 cm, 3 ¹ / ₂ "	026-299-09	5,0 cm, 2"	
11,0 cm, 4 ³ / ₈ "	026-299-11	6,9 cm, 2 ³ / ₄ "	

GLOVER

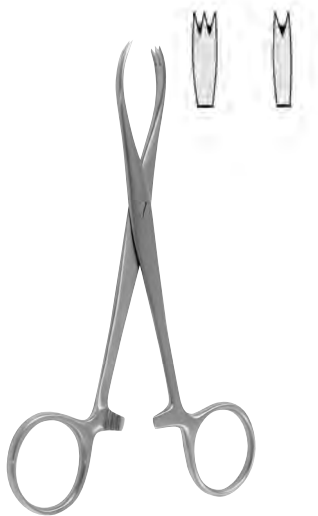

CHAPUT
13,0 cm, 5"
040-370-13



TUFFIER
13,0 cm, 5"
040-372-13



COLLIN
16,0 cm, 6¹/₄"
040-376-16

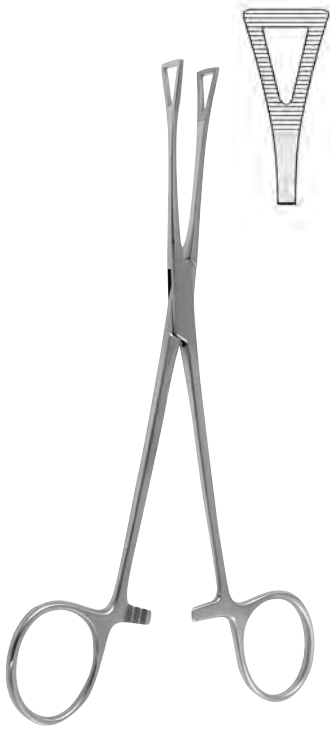

PENNINGTON
 15,5 cm, 6" **040-358-15**
 20,0 cm, 8" **040-358-20**



ATRAUMA



25,0 cm, 9³/₄"
040-658-25



27,0 cm, 10¹/₂"
040-658-27

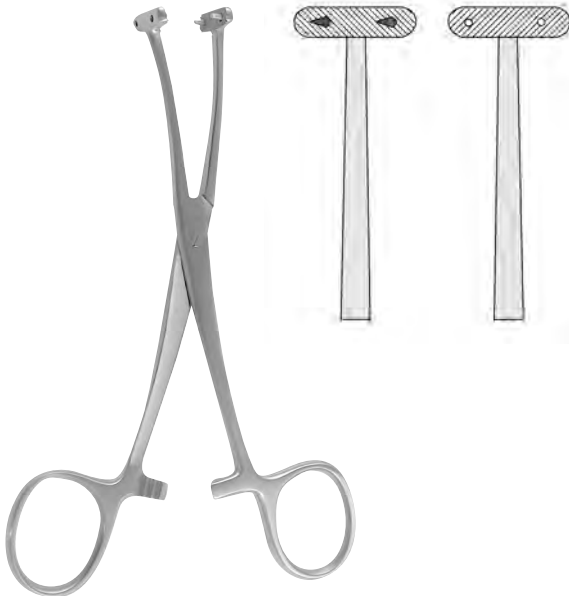

MARTEL
 14,0 cm, 5¹/₂"
040-364-14



WILLET-MARTEL
 19,0 cm, 7¹/₂"
040-366-19



PRATT
15,0 cm, 6"
040-656-15



FERGUSSON

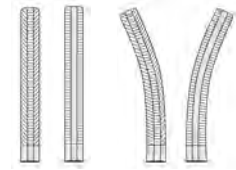

16,0 cm, 6 ¹ / ₄ "	040-650-16	040-651-16
20,0 cm, 8"	040-650-20	040-651-20



CARREL
10,0 cm, 4"
040-010-10



TERRIER
10,0 cm, 4"
040-016-10



KROENLEIN
13,0 cm, 5"
040-369-13



PEAN
 14,0 cm, 5½" **040-368-14**
 16,0 cm, 6¼" **040-368-16**



040-475-01

040-475-02

BABY-MIXTER
 14,0 cm, 5½"



SPENCER-WELLS

13,0 cm, 5"	040-290-13	040-291-13
15,0 cm, 6"	040-290-15	040-291-15
18,0 cm, 7"	040-290-18	040-291-18
20,0 cm, 8"	040-290-20	040-291-20



HARTMANN
 10,0 cm, 4"

040-000-10

040-001-10

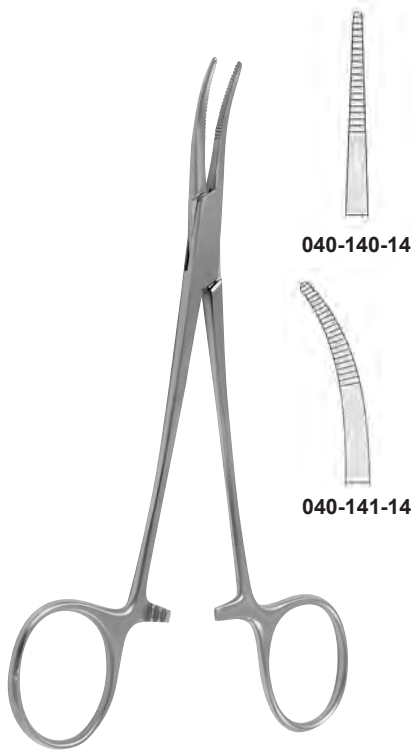

040-140-14

040-141-14

PROVICENCE-HOSPITAL
14,0 cm, 5 1/2"



HALSTED-MOSQUITO



12,5 cm, 5" **040-050-12** **040-051-12**
14,0 cm, 9 3/4" **040-050-14** **040-051-14**

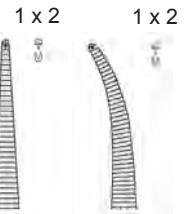

12,5 cm, 5" **040-070-12** **040-071-12**
14,0 cm, 9 3/4" **040-070-14** **040-071-14**



HALSTED-MOSQUITO

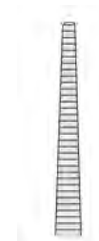

18,0 cm, 7"
040-050-18



18,0 cm, 7"
040-051-18



21,0 cm, 8 1/4"
040-050-21



21,0 cm, 8 1/4"
040-051-21



18,0 cm, 7"
040-070-18



18,0 cm, 7"
040-071-18



21,0 cm, 8 1/4"
040-070-21



21,0 cm, 8 1/4"
040-071-21

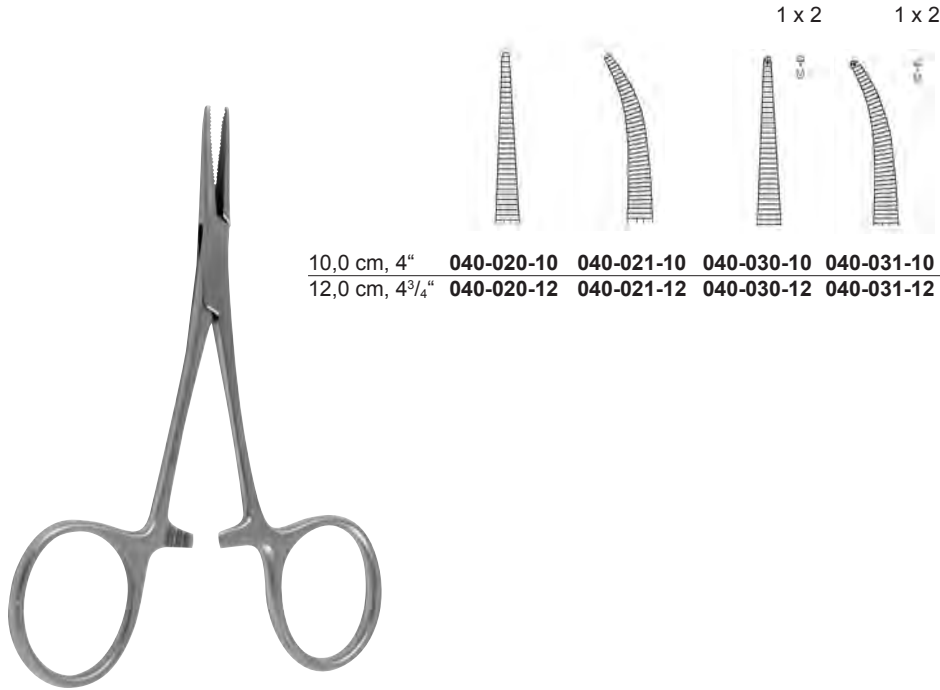

MICRO-MOSQUITO

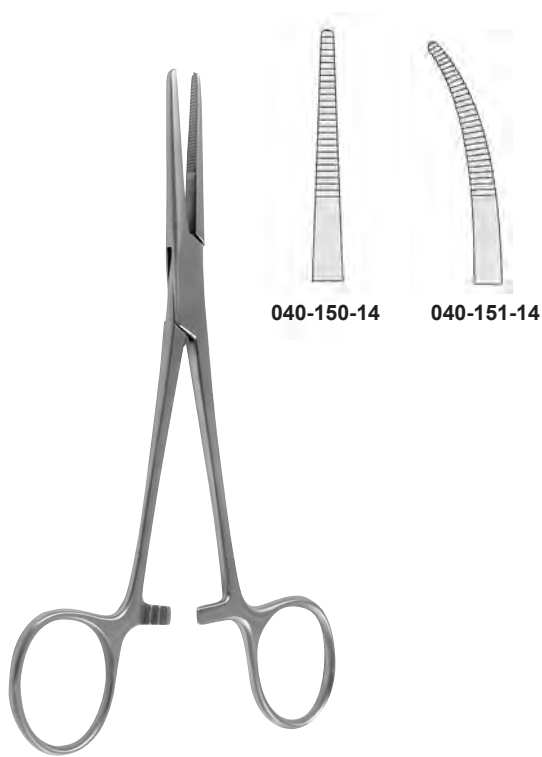

KELLY
14,0 cm, 5¹/₂"

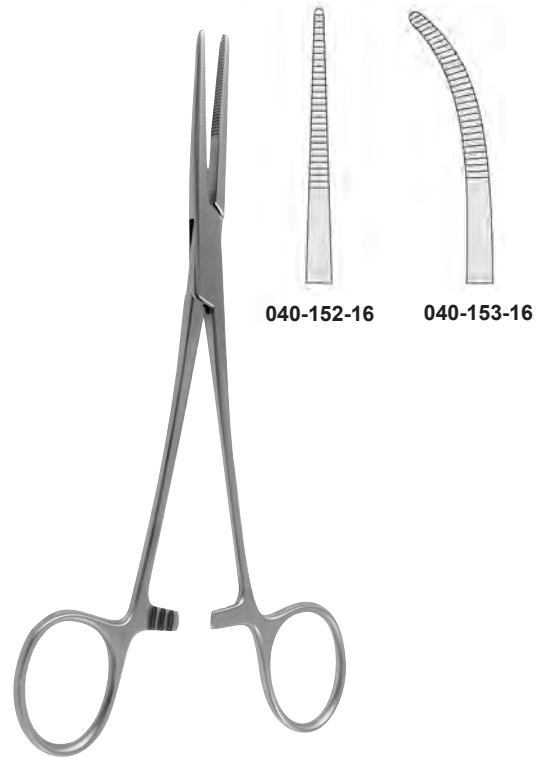

KELLY-RANKIN
16,0 cm, 6¹/₄"



LERICHE
15,0 cm, 6"



BABY-OVERHOLT
13,5 cm, 5 1/4"
040-424-14



DANDY
14,0 cm, 5 1/2"



CRILE
14,0 cm, 5 1/2"



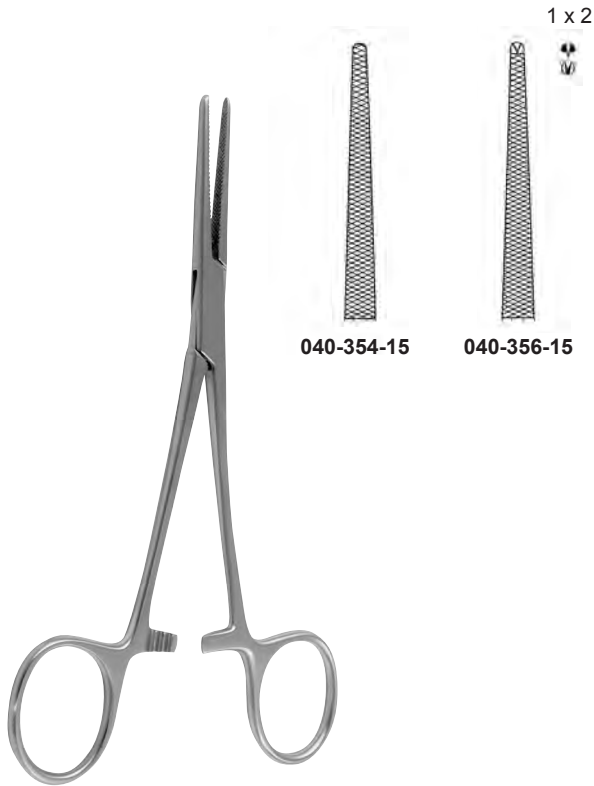

DIXON-LOVELACE
15,0 cm, 6"

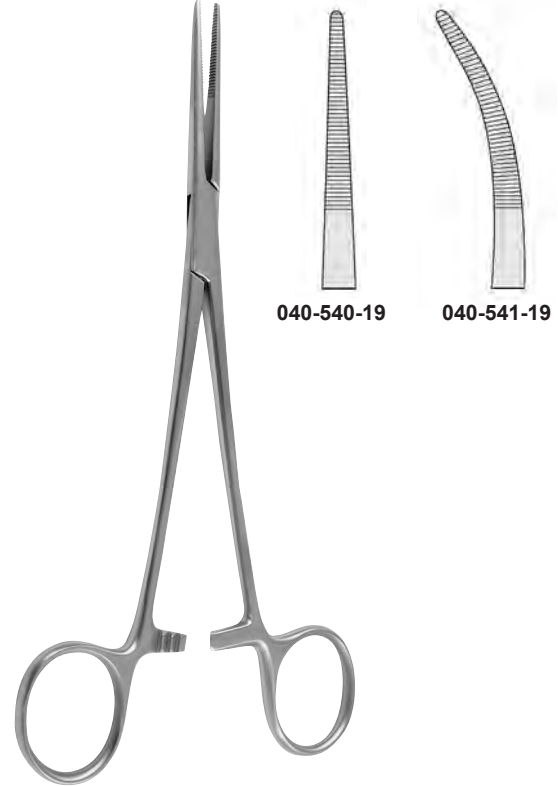

BIRKETT
19,0 cm, 7 1/2"

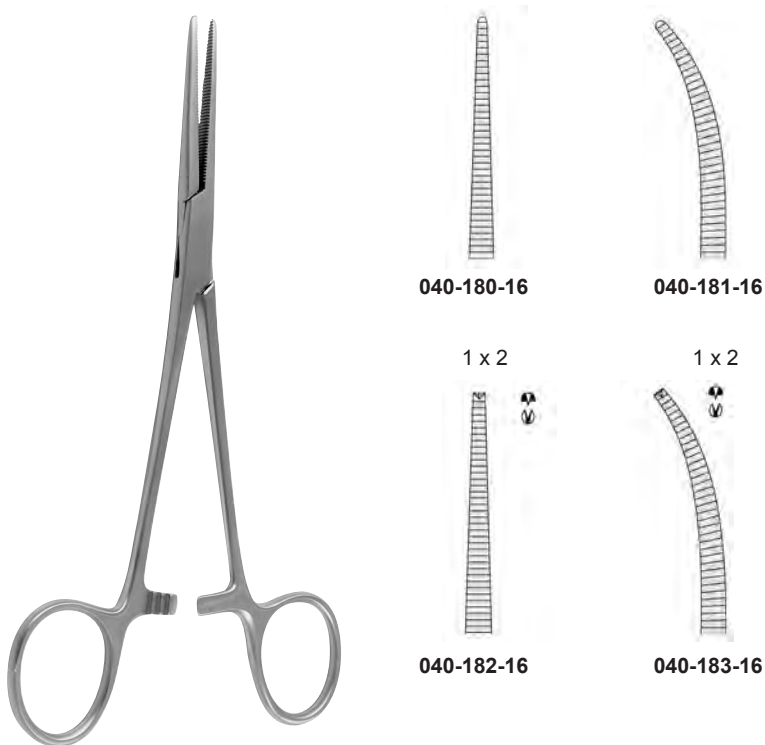

CRILE-RANKIN
16,0 cm, 6 1/4"

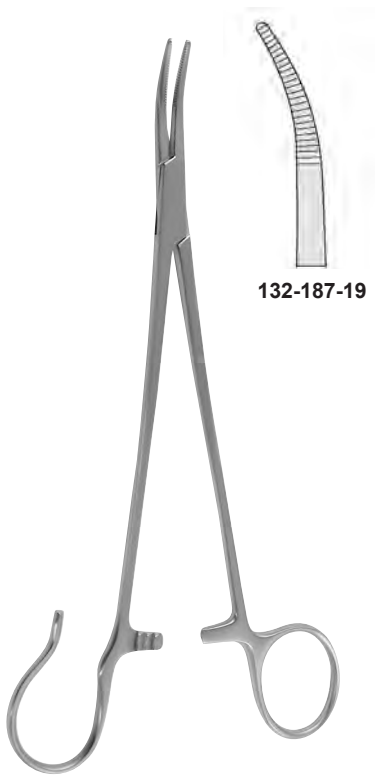

SCHNIDT
19,0 cm, 7½"

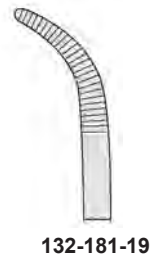
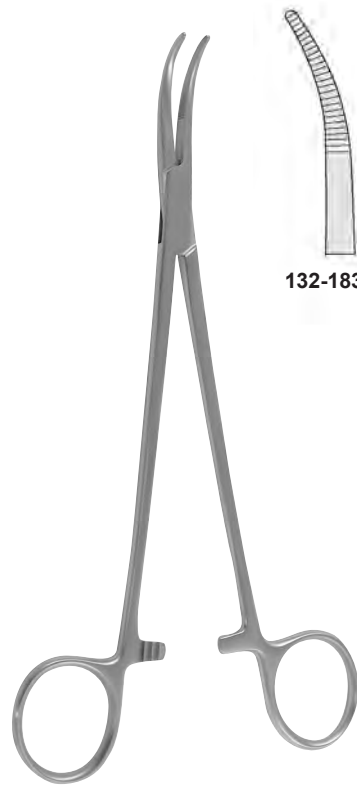

SCHNIDT-SAWTELL
19,0 cm, 7½"

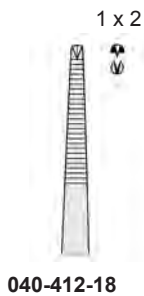

ADSON
18,5 cm, 7¼"



CRAFOORD
24,0 cm, 9½"
040-453-24



15,0 cm, 6"	040-480-15	040-481-15
18,5 cm, 7 1/4"	040-480-18	040-481-18

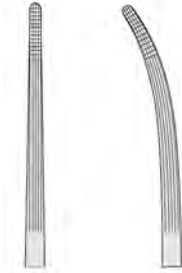

BAINBRIDGE



16,0 cm, 6 1/4"	040-340-16	040-341-16
20,0 cm, 8"	040-340-20	040-341-20

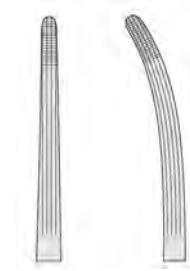

ROCHESTER-CARMALT



13,0 cm, 5"	040-262-13	040-263-13
14,0 cm, 5 1/2"	040-262-14	040-263-14
16,0 cm, 6 1/4"	040-262-16	040-263-16

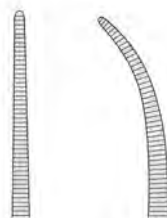

PEAN DELICATE



13,0 cm, 5"	040-352-13	040-353-13
14,0 cm, 5 1/2"	040-352-14	040-353-14
16,0 cm, 6 1/4"	040-352-16	040-353-16

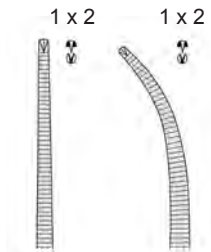

KOCHER DELICATE



ROCHESTER-PEAN

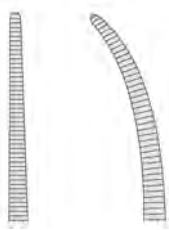

14,0 cm, 5½"	040-260-14	040-261-14
16,0 cm, 6¼"	040-260-16	040-261-16
18,0 cm, 7"	040-260-18	040-261-18
20,0 cm, 8"	040-260-20	040-261-20
22,0 cm, 8⅝"	040-260-22	040-261-22
24,0 cm, 9½"	040-260-24	040-261-24
26,0 cm, 10¼"	040-260-26	040-261-26
30,0 cm, 12"	040-260-30	040-261-30

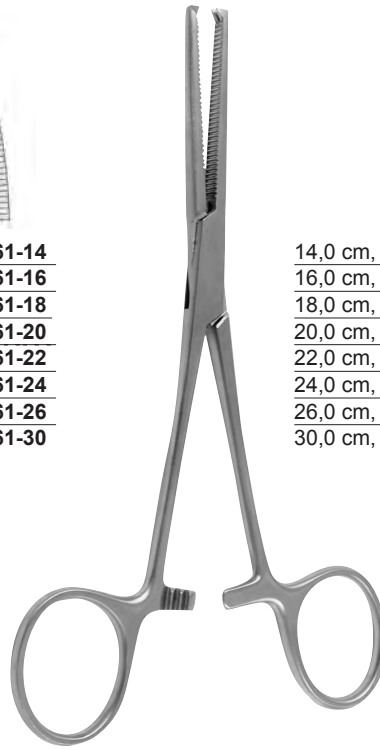

KOCHER-OCHSNER

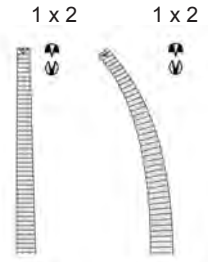

14,0 cm, 5½"	040-350-14	040-351-14
16,0 cm, 6¼"	040-350-16	040-351-16
18,0 cm, 7"	040-350-18	040-351-18
20,0 cm, 8"	040-350-20	040-351-20
22,0 cm, 8⅝"	040-350-22	040-351-22
24,0 cm, 9½"	040-350-24	040-351-24
26,0 cm, 10¼"	040-350-26	040-351-26
30,0 cm, 12"	040-350-30	040-351-30



BENGOLEA

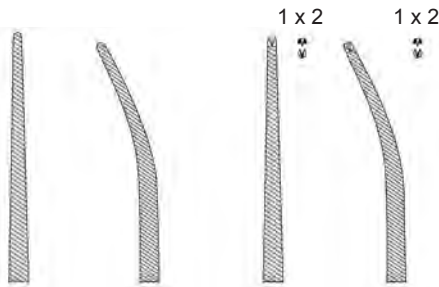

20,0 cm, 8"	040-384-20	040-385-20	040-386-20	040-387-20
26,0 cm, 10¼"	040-384-26	040-385-26	040-386-26	040-387-26

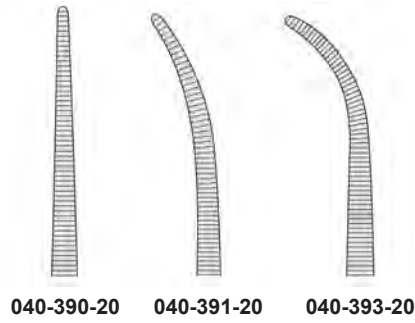
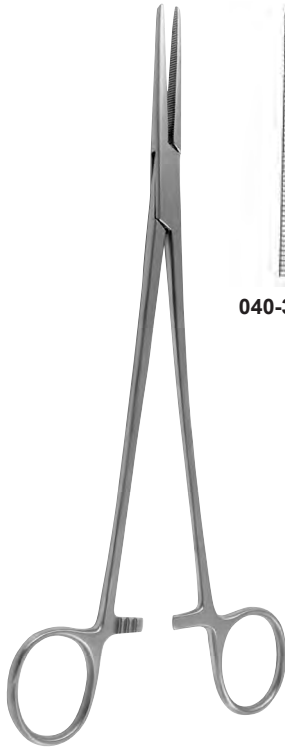

HEISS
20,0 cm, 8"

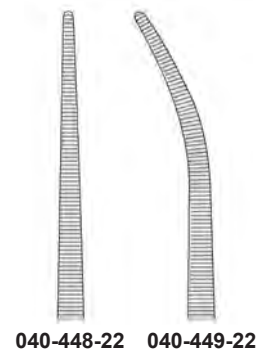

ROBERTS
22,0 cm, 8⁵/₈"

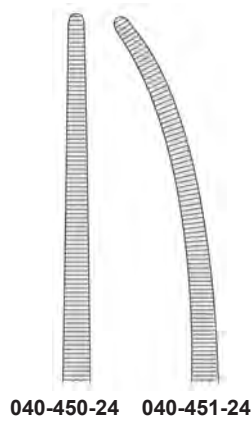

SAROT
24,0 cm, 9¹/₂"

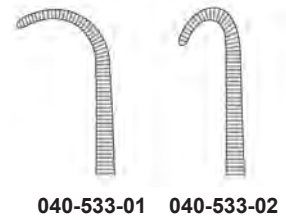

NEGUS
19,0 cm, 7¹/₂"



14,0 cm, 5½"
040-411-14 18,0 cm, 7"
040-411-18

BABY-ADSON



MICRO-ADSON
14,0 cm, 5½"
040-409-14



BABY-MIXTER
18,0 cm, 7"
040-475-18



OVERHOLT-MIXTER
21,0 cm, 8¼"
040-471-21



JOHNS HOPKINS
20,0 cm, 8"
040-497-20



OVERHOLT

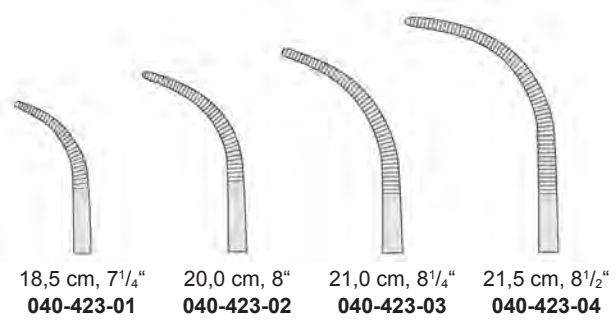

RUMEL
23,0 cm, 9"

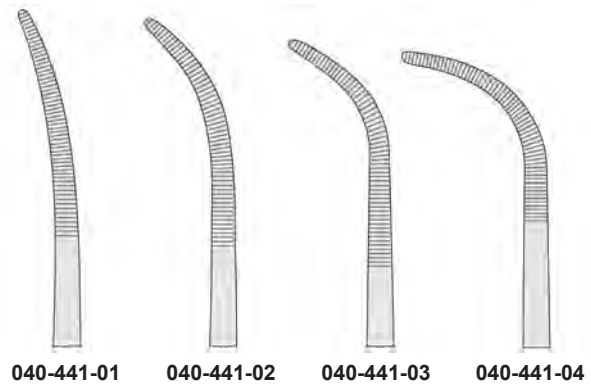

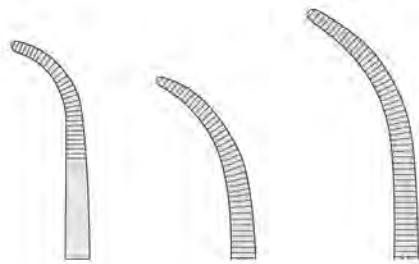

040-421-01 20,5 cm, 7³/₄"
040-421-02 20,0 cm, 7¹/₂"
040-421-03 21,5 cm, 8¹/₄"

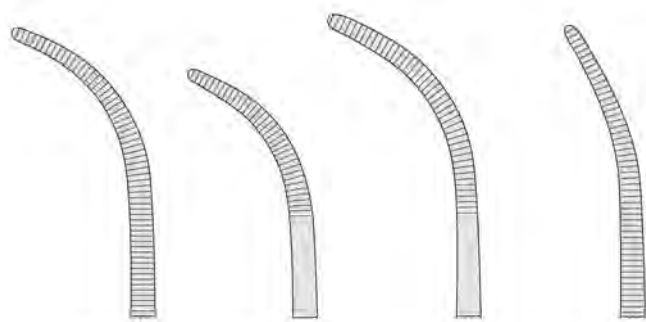

040-421-04 22,0 cm, 8³/₄"
040-421-05 21,5 cm, 8¹/₂"
040-421-06 22,0 cm, 8³/₄"
040-421-07 22,0 cm, 8³/₄"



OVERHOLT-GEISSENDOERFER

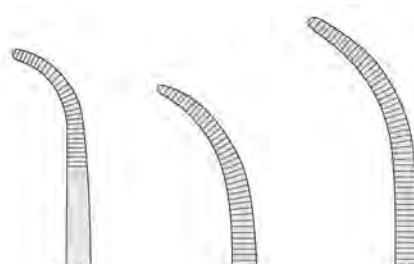

040-422-01 27,0 cm, 10³/₄"
040-422-02 26,0 cm, 10¹/₄"
040-422-03 27,0 cm, 10³/₄"

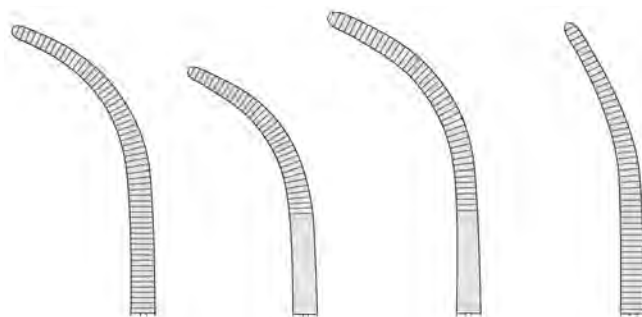

040-422-04 27,5 cm, 10³/₄"
040-422-05 27,5 cm, 10³/₄"
040-422-06 28,0 cm, 11"
040-422-07 28,0 cm, 11"

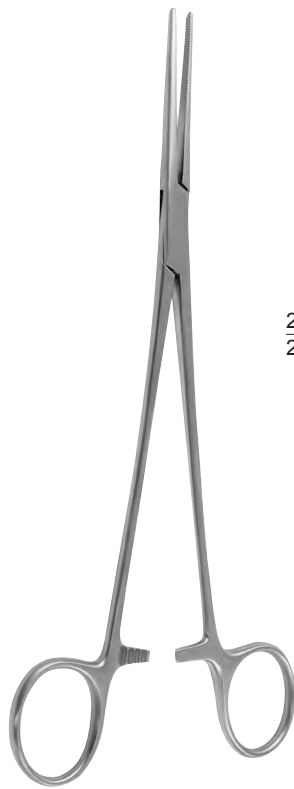

TOENNIS

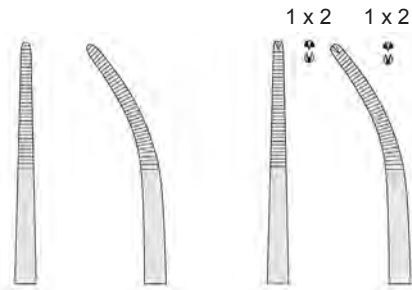

21,0 cm, 8 ¹ / ₄ "	040-442-21	040-443-21	040-444-21	040-445-21
26,0 cm, 10 ¹ / ₄ "	040-442-26	040-443-26	040-444-26	040-445-26



KELLY

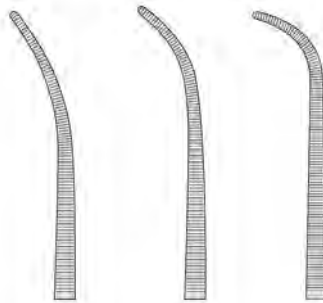

19,0 cm, 7 ¹ / ₂ "	040-463-19	040-465-19	040-467-19
22,0 cm, 8 ⁵ / ₈ "	040-463-22	040-465-22	040-467-22
24,0 cm, 9 ¹ / ₂ "	040-463-24	040-465-24	040-467-24



18,0 cm, 7"	040-429-18
22,0 cm, 8 ⁵ / ₈ "	040-429-22
25,0 cm, 9 ³ / ₄ "	040-429-25
28,0 cm, 11"	040-429-28

MINI-GEMINI



14,0 cm, 5 ¹ / ₂ "	040-431-14
16,0 cm, 6 ¹ / ₄ "	040-431-16
18,0 cm, 7"	040-431-18
20,0 cm, 8"	040-431-20
23,0 cm, 9"	040-431-23
25,0 cm, 9 ³ / ₄ "	040-431-25
28,0 cm, 11"	040-431-28

GEMINI



20,0 cm, 8"	040-433-20
24,0 cm, 9 ¹ / ₂ "	040-433-24
28,0 cm, 11"	040-433-28

KANTROWITZ

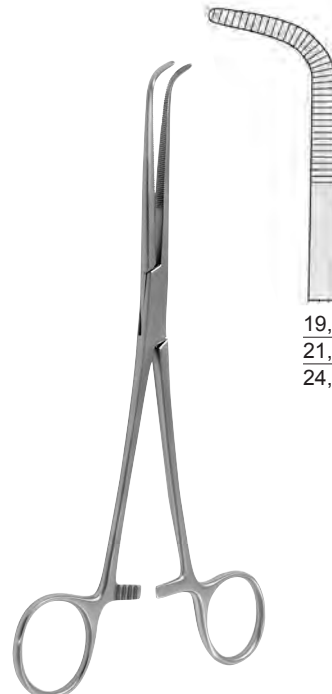

19,0 cm, 7 ¹ / ₂ "	040-543-19
21,0 cm, 8 ¹ / ₄ "	040-543-21
24,0 cm, 9 ¹ / ₂ "	040-543-24

WIKSTROEM



MIXTER
 15,5 cm, 6" **040-461-15**
 19,0 cm, 7½" **040-461-19**



MIXTER-O'SHAUGNESSY
 15,5 cm, 6" **040-477-15**
 19,0 cm, 7½" **040-477-19**



MIXTER
 22,0 cm, 8¾" **040-473-22**



MIXTER
 23,0 cm, 9" **040-473-23**



ZENKER

040-455-01 040-455-02



ZENKER

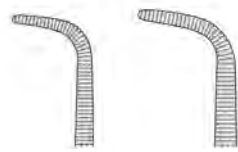

040-459-18 040-459-28



LAWRENCE
27,5 cm, 10³/₄"
040-457-28



HOSEMANN
21,0 cm, 8¹/₄"

1 x 2
040-436-21 040-438-21



DESJARDINS
21,0 cm, 8¹/₄"
040-529-21



MIXTER
22,0 cm, 8³/₄" 040-479-22
25,0 cm, 9³/₄" 040-479-25
28,0 cm, 11" 040-479-28



LAHEY
19,0 cm, 7¹/₂" 040-501-19
23,0 cm, 9" 040-501-23



LOWER
18,0 cm, 7"
040-503-18



MC QUIGG-MIXTER
22,0 cm, 8³/₄"
040-507-22

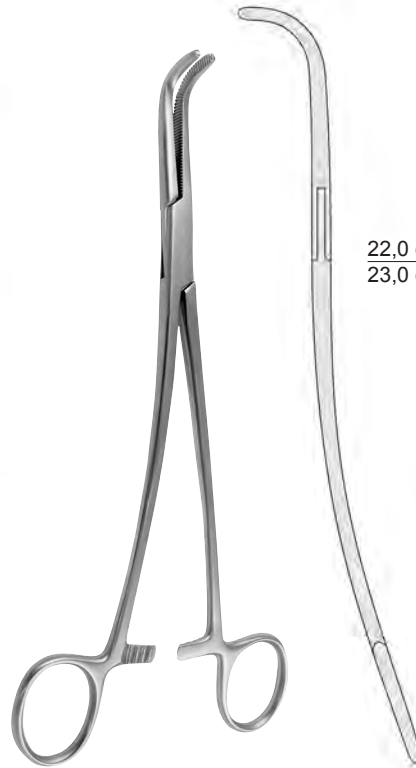

GRAY

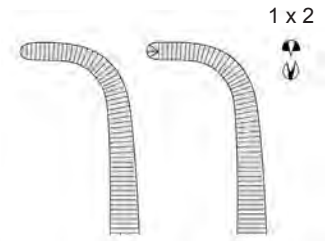

22,0 cm, 8 ³ / ₄ "	040-523-22	040-525-22
23,0 cm, 9"	040-523-23	040-525-23



CRAFOORD-SELLORS

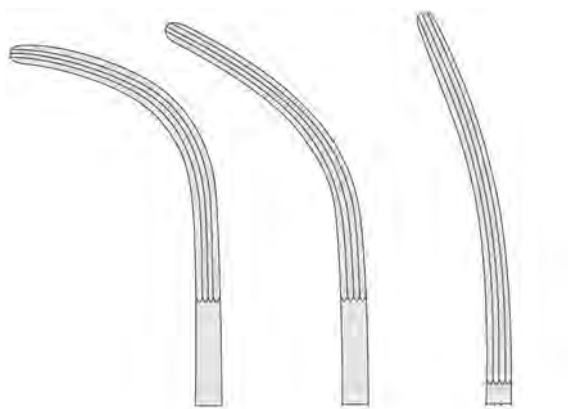

22,0 cm, 8 ³ / ₄ "	23,0 cm, 9"	24,0 cm, 9 ¹ / ₂ "
040-456-22	040-456-23	040-456-24



FINOCCHIETTO
24,0 cm, 9¹/₂"
040-505-24



GUYON
 20,0 cm, 8" **040-509-20**
 22,0 cm, 8³/₄" **040-509-22**
 24,0 cm, 9¹/₂" **040-509-24**

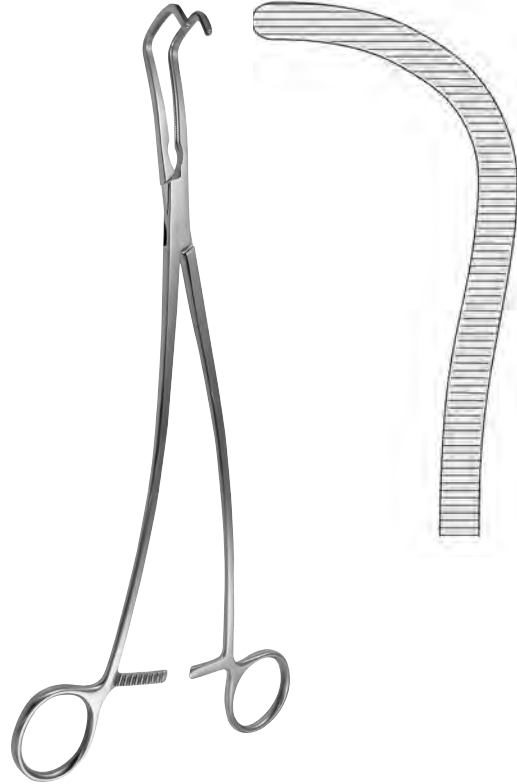

GUYON
 23,0 cm, 9"
040-513-23

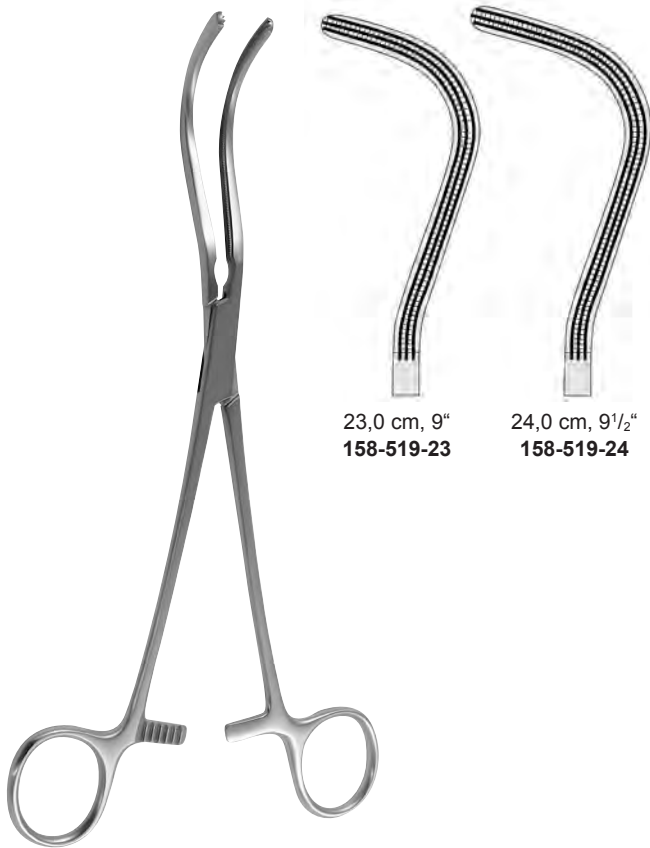

GUYON

23,0 cm, 9"
158-519-23

24,0 cm, 9¹/₂"
158-519-24



STILLE
 23,0 cm, 9"
040-511-23



HERRICK
23,0 cm, 9"
040-517-23



URO-TANGENTIAL



23,0 cm, 9"
170-055-01

24,0 cm, 9½"
170-055-02



LOVELACE
20,0 cm, 8"
141-004-20

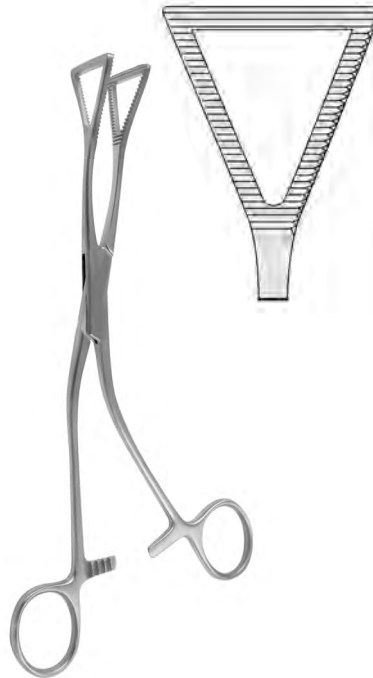

LOVELACE
20,0 cm, 8"
141-005-20



PRICE-THOMAS
22,0 cm, 8¾"
141-001-22



PRICE-THOMAS
22,0 cm, 8³/₄"



141-002-01



141-002-02



SEMB
24,0 cm, 9¹/₂"

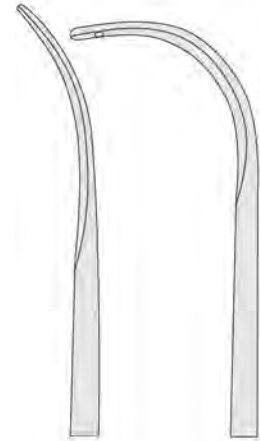

141-003-01

141-003-02



BABY-MIKULICZ
14,0 cm, 5¹/₂"
040-701-14

1 x 2



MIKULICZ
18,0 cm, 7"
040-703-18

1 x 2



MIKULICZ
20,0 cm, 8"
040-709-20

1 x 2



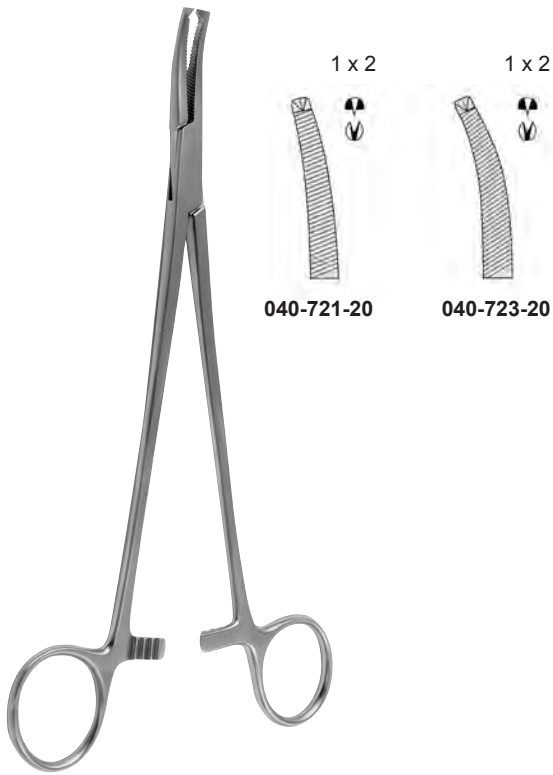

FAURE
20,0 cm, 8"

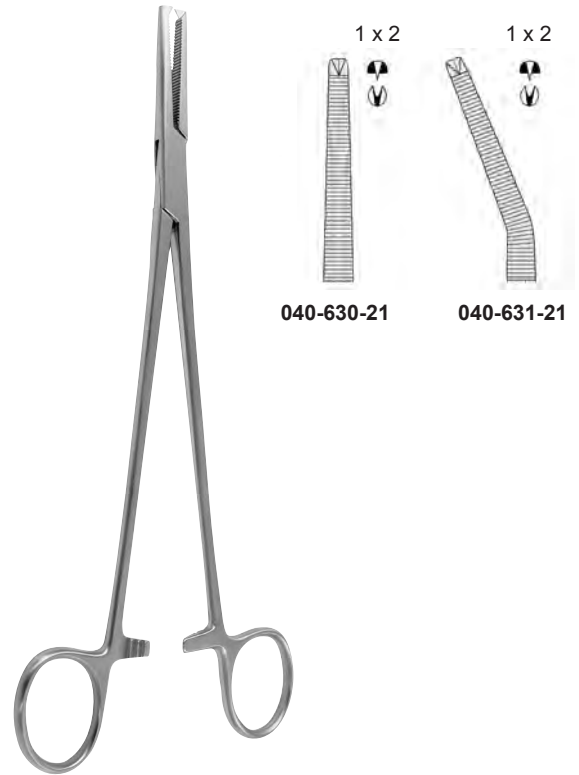

PHANEUF
21,5 cm, 8½"

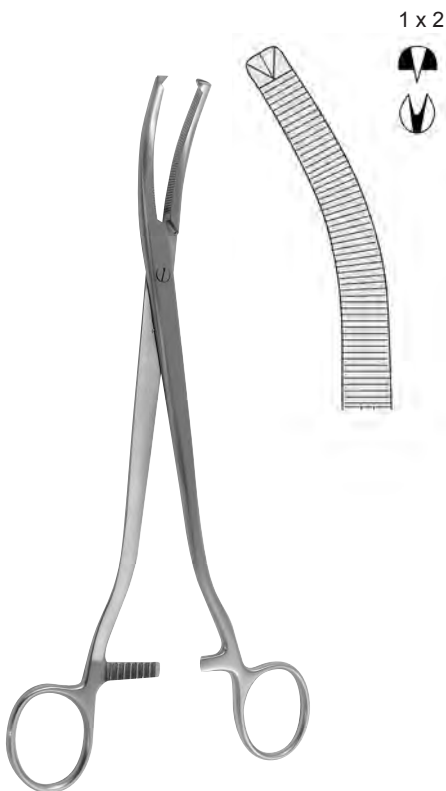

WERTHEIM
24,0 cm, 9½"

040-601-24



WERTHEIM
25,0 cm, 10"

040-602-25

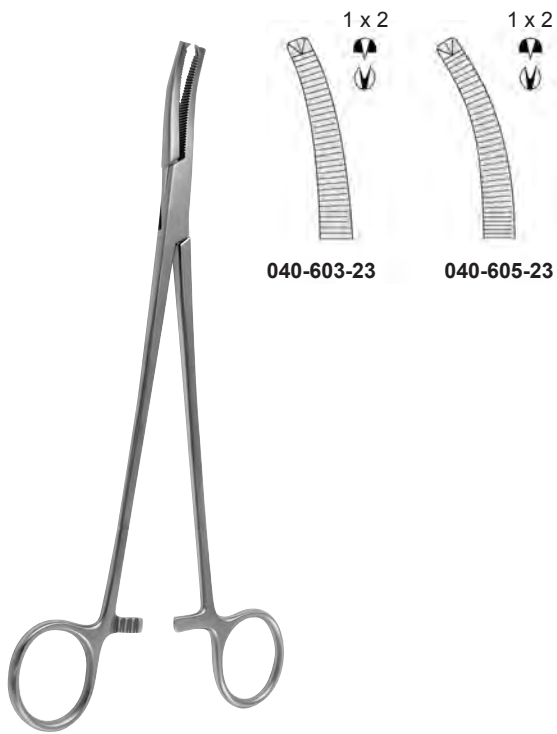

040-603-23

040-605-23

WERTHEIM
23,0 cm, 9"

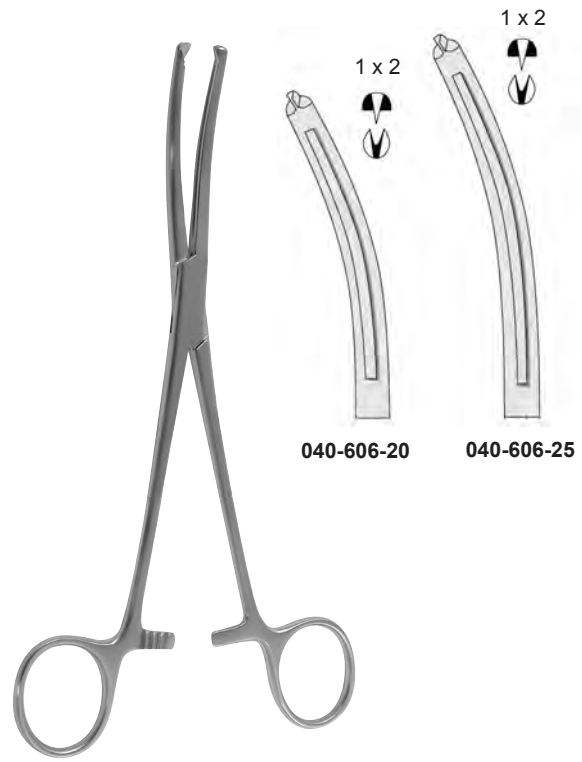

040-606-20

040-606-25

MAINGOT
21,5 cm, 8 1/2"



23,0 cm, 9"
040-625-23

24,0 cm, 9 1/2"
040-627-24

MOYNIHAN



WERTHEIM-CULLEN
21,5 cm, 8 1/2"
040-629-21



LONG
19,0 cm, 7¹/₄"
040-621-19

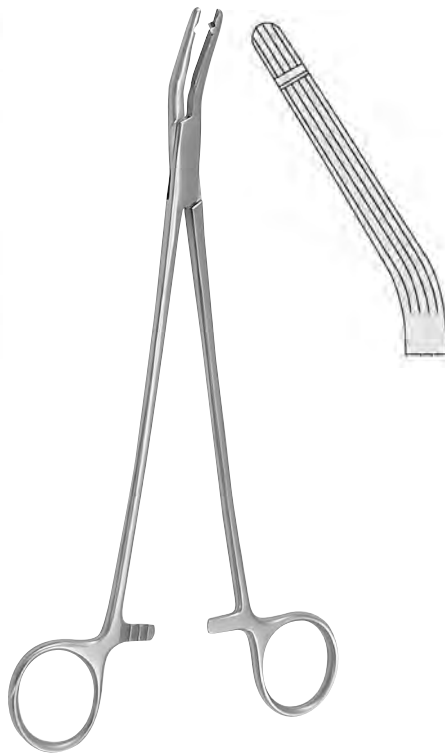

GARLAND
21,0 cm, 8¹/₄"
040-623-21



HEANEY
21,0 cm, 8¹/₄"
040-607-21



HEANEY-BALLANTINE
21,0 cm, 8¹/₄"

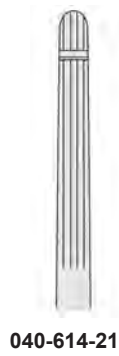

HEANEY-KANTER
21,0 cm, 8¹/₄"

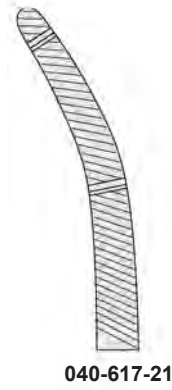

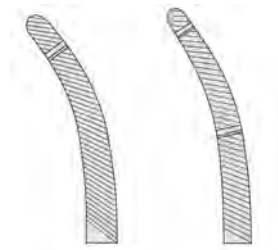
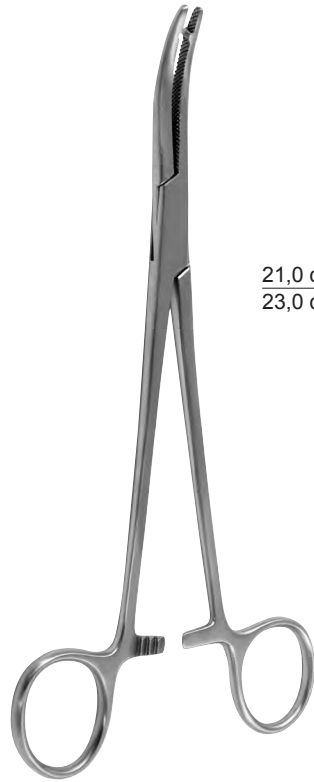

21,0 cm, 8 ¹ / ₄ "	040-611-21	040-613-21
23,0 cm, 9"	040-611-23	040-613-23

HEANEY

Suture Instruments



DERF



COLLIER
12,5 cm, 5"
050-022-12



WEBSTER
13,0 cm, 5"
050-028-13



HALSEY
13,0 cm, 5"

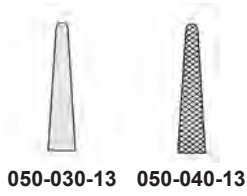

NEIVERT
13,0 cm, 5"
050-046-13



HEGAR-BAUMGARTNER
14,0 cm, 5¹/₂"
050-048-14



050-096-13
13,0 cm, 5"

BROWN



CRILE-MURRAY
15,0 cm, 6"
050-070-15



050-060-15
15,0 cm, 6"

CRILE-WOOD



ADSON
18,0 cm, 7"
050-192-18



METZENBAUM
18,0 cm, 7"
050-190-18



MASS.-GENERAL-HOSPITAL
17,0 cm, 6³/₄"
050-072-17



MAYO-HEGAR

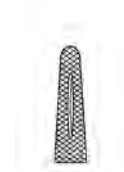

050-080-14
14,0 cm, 5½"



050-080-16
16,0 cm, 6¼"

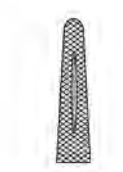

050-080-18
18,0 cm, 7"

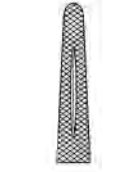

050-080-20
20,0 cm, 8"

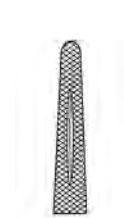

050-080-24
24,0 cm, 9½"

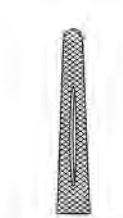

050-080-26
26,0 cm, 10¼"

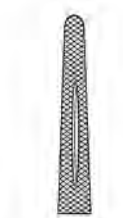

050-080-30
30,0 cm, 12"



MAYO-HEGAR-DELICATE



050-090-16
16,0 cm, 6¼"



050-090-18
18,0 cm, 7"



050-090-20
20,0 cm, 8"



LAWRENCE
15,0 cm, 6"
050-110-15



HEANEY
21,0 cm, 8¹/₄"
050-141-21



JAMISON
23,5 cm, 9¹/₄"
050-148-23



MASSON
27,0 cm, 10¹/₂"
050-150-27



FINOCCHIETTO
27,0 cm, 10¹/₂"
050-211-27



WANGENSTEEN
27,0 cm, 10¹/₂"
050-160-27

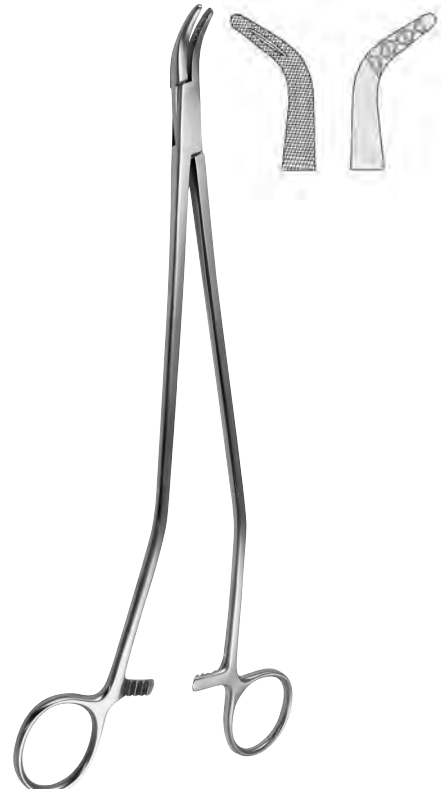

JOHNSON
27,0 cm, 10¹/₂"
050-193-27



STRATTE
23,0 cm, 9"
050-230-23



OLSEN-HEGAR
17,0 cm, 6³/₄"
050-310-17

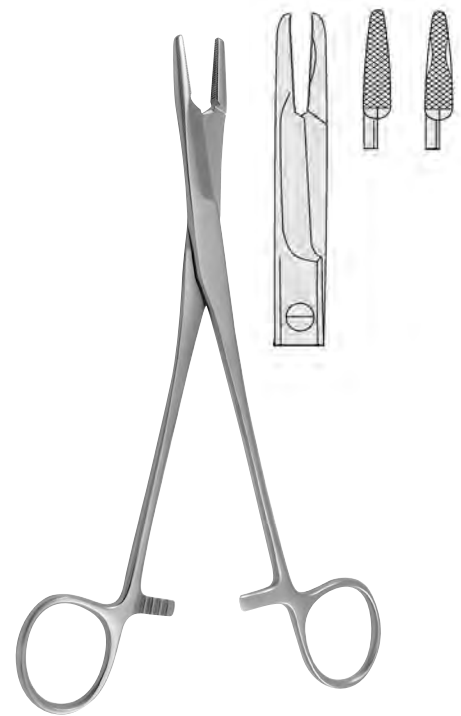

OLSEN-HEGAR
14,0 cm, 5¹/₂"
050-306-14



OLSEN-HEGAR

14,0 cm, 5¹/₂"
050-310-14

18,0 cm, 7"
050-310-18



TOENNIS
18,0 cm, 7"
050-362-18



MATHIEU



050-350-14
14,0 cm, 5½"



050-350-17
17,0 cm, 6¾"



050-350-20
20,0 cm, 8"



MATHIEU



050-356-17
17,0 cm, 6¾"



050-356-20
20,0 cm, 8"



LICHTENBERG
20,0 cm, 8"
050-366-20

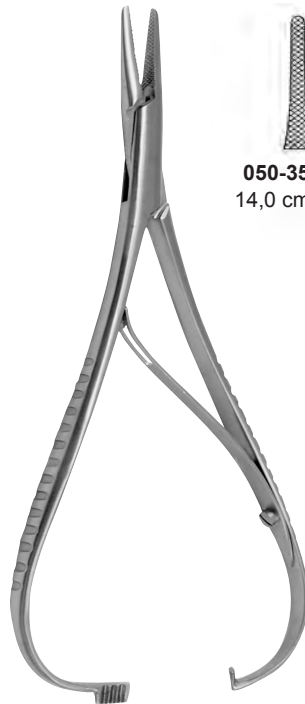

MATHIEU



050-354-14
14,0 cm, 5½"



050-354-17
17,0 cm, 6¾"



050-358-14
14,0 cm, 5½"



050-358-17
17,0 cm, 6¾"



050-358-20
20,0 cm, 8"



MATHIEU-KOCHER



050-550-10

050-551-10



BARRAQUER-TROUTMAN
10,0 cm, 4"



050-553-10 **050-553-13**



BARRAQUER



BARRAQUER
13,5 cm, 5⅜"
050-621-13



GOMEL
14,0 cm, 5½"
050-601-14

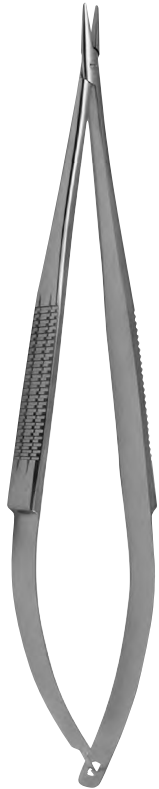

050-600-18 050-601-18

ohne Sperre
without ratchet
sin cremallera
senza cremagliera

18,5 cm, 7 1/4"



050-630-18 050-631-18

mit Sperre
with ratchet
con cremallera
con cremagliera

18,5 cm, 7 1/4"



050-570-14 050-571-14

050-576-14 050-577-14

mit Sperre
with ratchet
con cremallera
con cremagliera

CASTROVIEJO
14,5 cm, 5 3/4"



050-570-18 050-571-18

050-576-18 050-577-18

mit Sperre
with ratchet
con cremallera
con cremagliera

CASTROVIEJO
18,0 cm, 7"

Micro Needle Holders

gerade, ohne Sperre
straight, without ratchet
recta, sin cremallera
retta, senza cremagliera

0,4 mm



14,0 cm, 5 1/2"
050-650-14

gebogen, ohne Sperre
curved, without ratchet
curva, sin cremallera
curva, senza cremagliera

0,4 mm

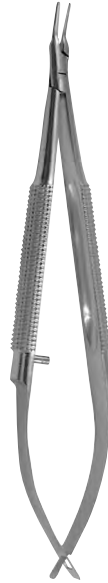

14,0 cm, 5 1/2"
050-651-14

gebogen, mit Sperre
curved, with ratchet
curva, con cremallera
curva, con cremagliera

0,4 mm



14,0 cm, 5 1/2"
050-653-14

gebogen, ohne Sperre
curved, without ratchet
curva, sin cremallera
curva, senza cremagliera

0,5 mm



14,0 cm, 5 1/2"
050-661-14

gebogen, mit Sperre
curved, with ratchet
curva, con cremallera
curva, con cremagliera

0,5 mm



Ø 10 mm

14,0 cm, 5 1/2"
050-663-14

gebogen, ohne Sperre
curved, without ratchet
curva, sin cremallera
curva, senza cremagliera

0,4 mm



Ø 8 mm

13,0 cm, 5"
050-671-13



KALT
13,5 cm, 5³/₈"
051-428-14



16,0 cm, 5³/₈" **051-250-16**
18,0 cm, 7" **051-250-18**
20,0 cm, 8" **051-250-20**
23,0 cm, 9" **051-250-23**
26,0 cm, 10¹/₄" **051-250-26**

DIETRICH



WEBSTER
13,0 cm, 5"
051-028-13



DERF
12,0 cm, 4³/₄"
051-010-12



HEGAR-BAUMGARTNER

051-048-12
12,5 cm, 5"

051-048-14
14,0 cm, 5¹/₂"

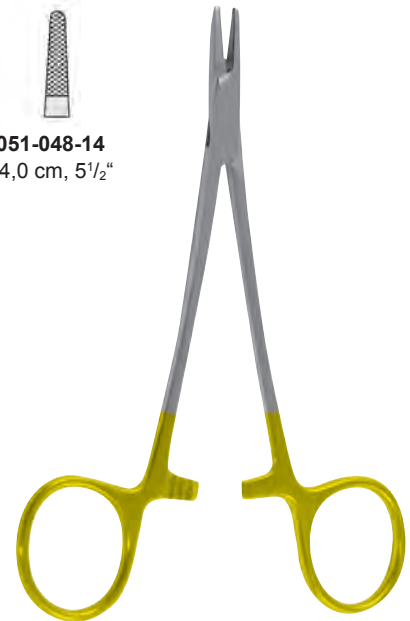

WEBSTER
13,0 cm, 5"
051-029-13



051-030-13

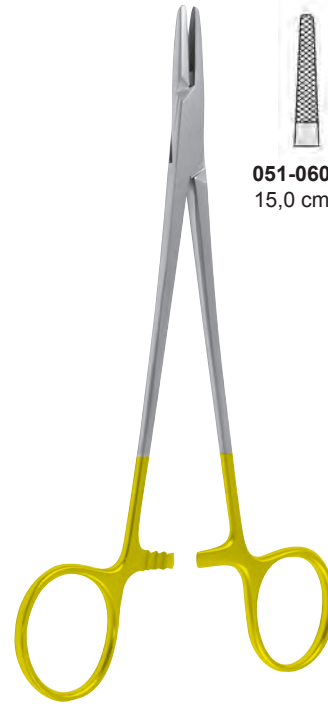

051-060-15
15,0 cm, 6"



HALSEY
13,0 cm, 5"

CRILE-WOOD

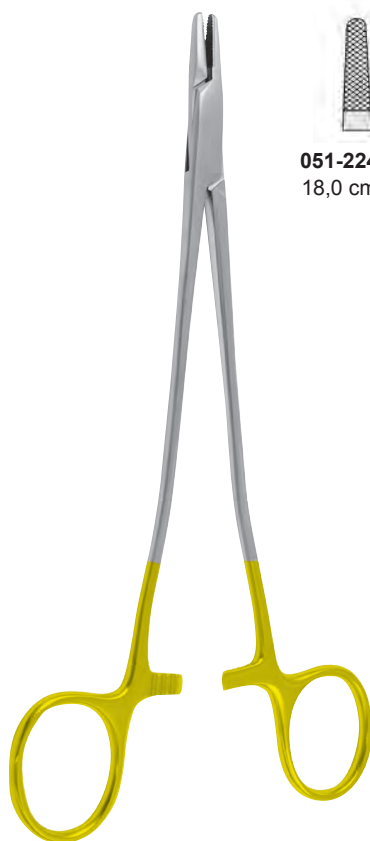

SAROT



MAYO-HEGAR



051-080-16
16,0 cm, 6¹/₄"



051-080-18
18,0 cm, 7"



051-080-20
20,0 cm, 8"

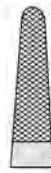

051-080-24
24,0 cm, 9¹/₂"



051-080-26
26,0 cm, 10¹/₄"



051-080-30
30,0 cm, 12"



MAYO-HEGAR (HEANEY)



051-141-20
20,0 cm, 8"



051-141-24
24,0 cm, 9¹/₄"



051-141-26
26,0 cm, 10¹/₄"



DE BAKEY



051-114-18
18,0 cm, 7"



051-114-20
20,0 cm, 8"



051-114-23
23,0 cm, 9"



051-114-26
26,0 cm, 10¹/₄"



051-114-31
31,0 cm, 12¹/₄"



051-114-37
37,0 cm, 14¹/₂"

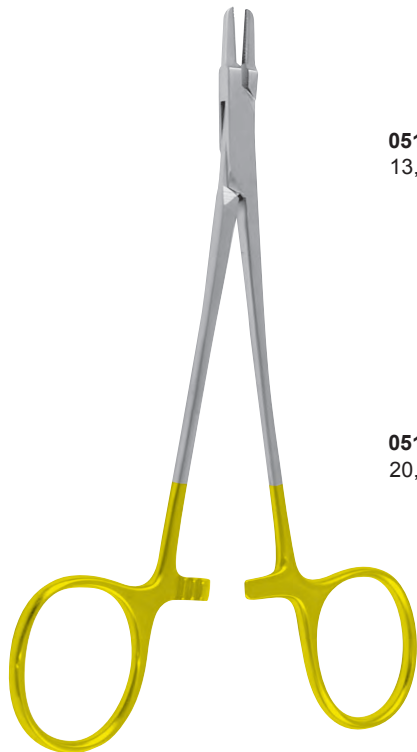

RYDER-VASCULAR



051-132-13
13,0 cm, 5"



051-132-15
15,0 cm, 6"



051-132-18
18,0 cm, 7"



051-132-20
20,0 cm, 8"



051-132-23
23,0 cm, 9"



051-132-26
26,0 cm, 10¹/₄"



RYDER



051-134-13
13,0 cm, 5"



051-134-15
15,0 cm, 6"



051-134-18
18,0 cm, 7"



051-134-20
20,0 cm, 8"



051-134-23
23,0 cm, 9"



051-134-26
26,0 cm, 10¹/₄"



SCHWEDISCHES MODELL



051-136-15
15,0 cm, 6"



051-136-17
17,0 cm, 6³/₄"



051-136-20
20,0 cm, 8"

Needle Holders with tungsten carbide inserts

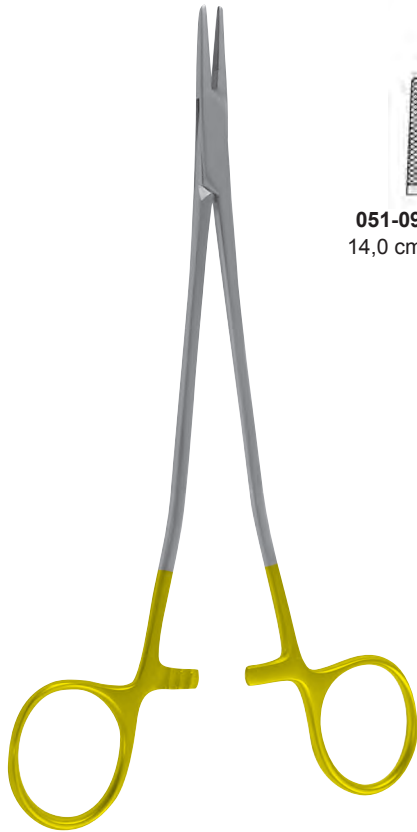

051-090-14
14,0 cm, 5½"

051-090-18
18,0 cm, 7"

051-090-20
20,0 cm, 8"

051-090-23
23,0 cm, 9"

MAYO-HEGAR (HEANEY)



FINOCCHIETTO
27,0 cm, 10½"
051-211-27

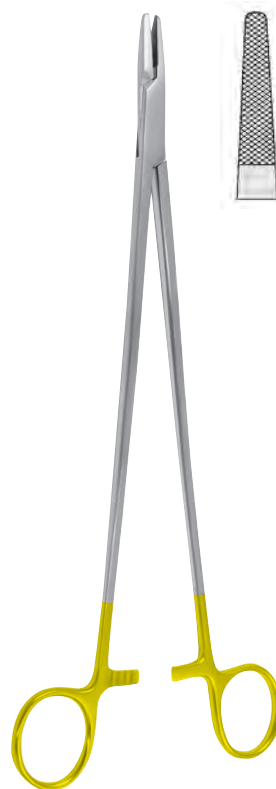

MASSON
27,0 cm, 10½"
051-150-27

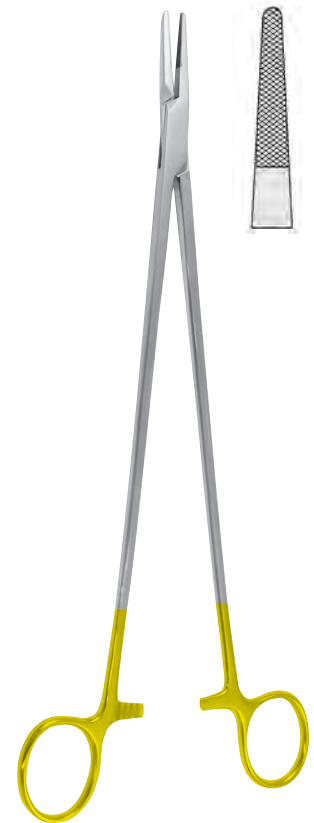

WANGENSTEEN
27,0 cm, 10½"
051-160-27



BOZEMANN

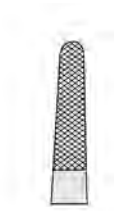

051-185-20
20,0 cm, 8"



051-185-24
24,0 cm, 9⁵/₈"

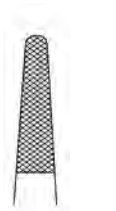

051-185-26
26,0 cm, 10¹/₄"

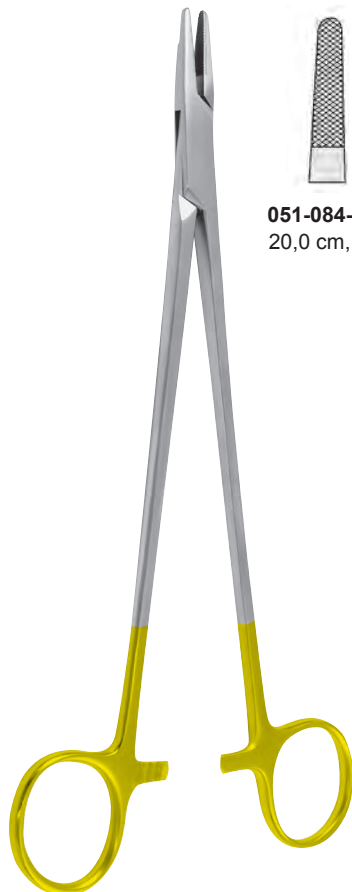

HEGAR



051-084-20
20,0 cm, 8"

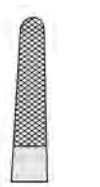

051-084-24
24,0 cm, 9⁵/₈"



BARRY STERNAL



051-240-15
15,0 cm, 6"



051-242-20
20,0 cm, 8"



STRATTE



051-230-22
22,0 cm, 8⁵/₈"



051-230-23
23,0 cm, 9"



GILLIES
16,0 cm, 6¹/₄"
051-330-16

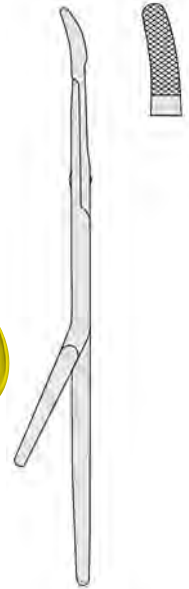

OLSEN-HEGAR



051-310-14
14,0 cm, 5¹/₂"



051-310-17
17,0 cm, 6³/₄"



051-310-18
18,0 cm, 7"



TOENNIS
18,0 cm, 7"
051-362-18



MATHIEU-KOCHER



MATHIEU

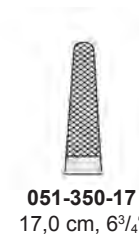



LICHTENBERG



051-366-17
17,0 cm, 6³/₄"



051-366-20
20,0 cm, 8"



MATHIEU

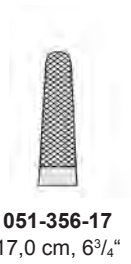

051-356-17
17,0 cm, 6³/₄"



051-356-20
20,0 cm, 8"



051-356-23
23,0 cm, 9"



ZWEIFEL



051-364-20
20,0 cm, 8"



051-364-23
23,0 cm, 9"



LANGENBECK



051-360-18
18,0 cm, 7"



051-360-20
20,0 cm, 8"



051-360-23
23,0 cm, 9"

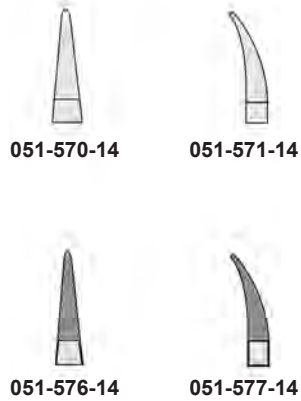

mit Sperre
with ratchet
con cremallera
con cremagliera

CASTROVIEJO
14,5 cm, 5³/₄"

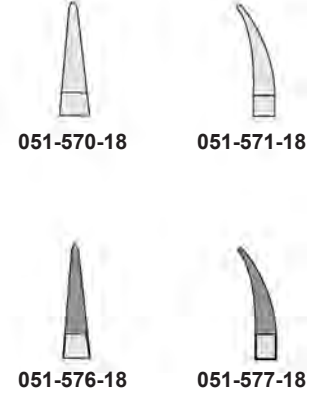

mit Sperre
with ratchet
con cremallera
con cremagliera

CASTROVIEJO
18,0 cm, 7"

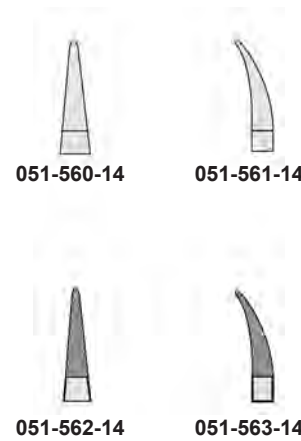

mit Sperre
with ratchet
con cremallera
con cremagliera

BARRAQUER
14,5 cm, 5³/₄"



HEPP SCHEIDEL
18,0 cm, 7"
051-390-18



REVERDIN
14,0 cm, 5½"

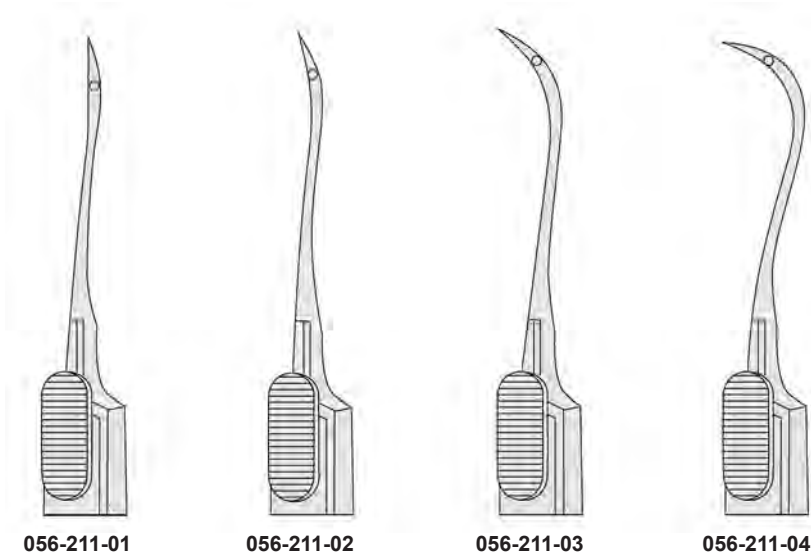

056-211-01

056-211-02

056-211-03

056-211-04



REVERDIN

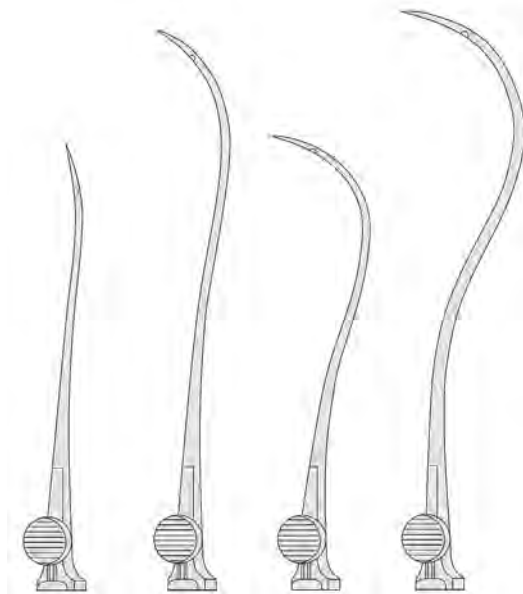

19,5 cm, 7¾" 056-221-01 056-221-02 056-221-03 056-221-04
22,5 cm, 8¾" 056-223-01 056-223-02 056-223-03 056-223-04

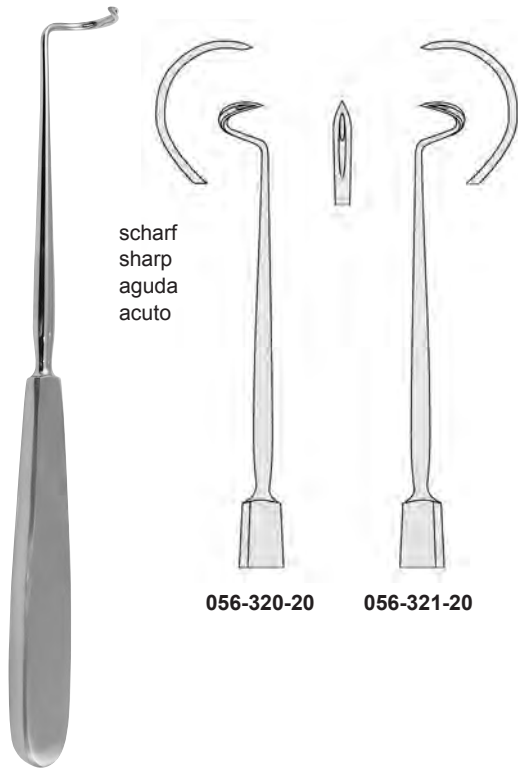

scharf
sharp
aguda
acuto

056-320-20

056-321-20

DESCHAMPS
20,0 cm, 8"

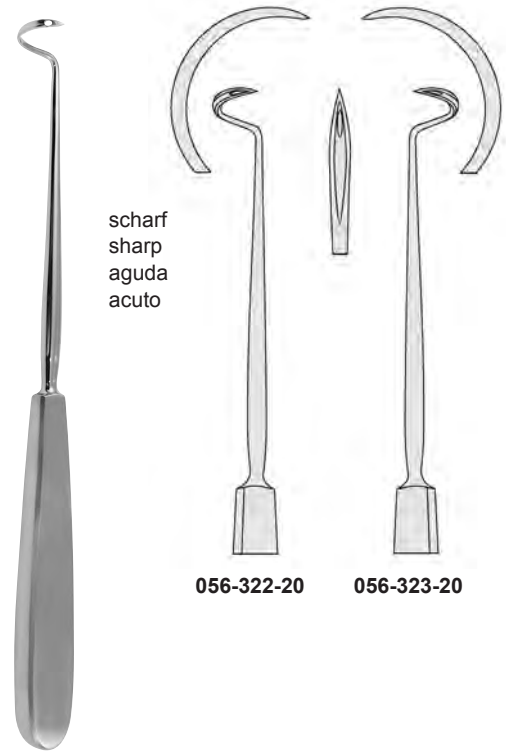

scharf
sharp
aguda
acuto

056-322-20

056-323-20

DESCHAMPS
20,0 cm, 8"

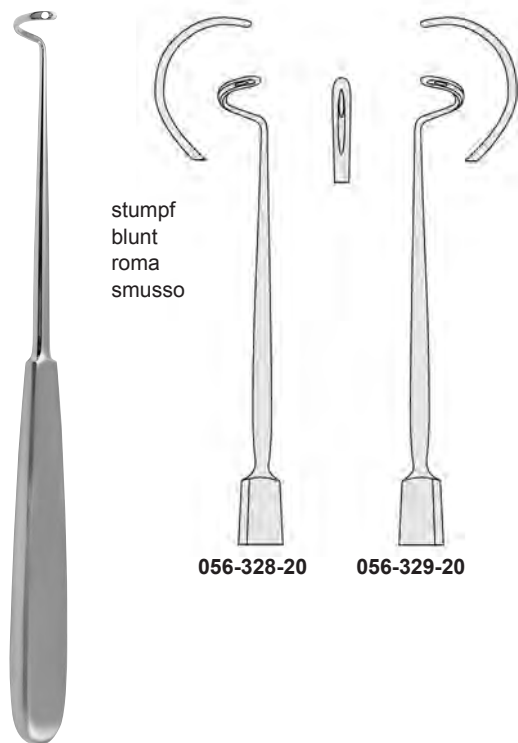

stumpf
blunt
roma
smusso

056-328-20

056-329-20

DESCHAMPS
20,0 cm, 8"

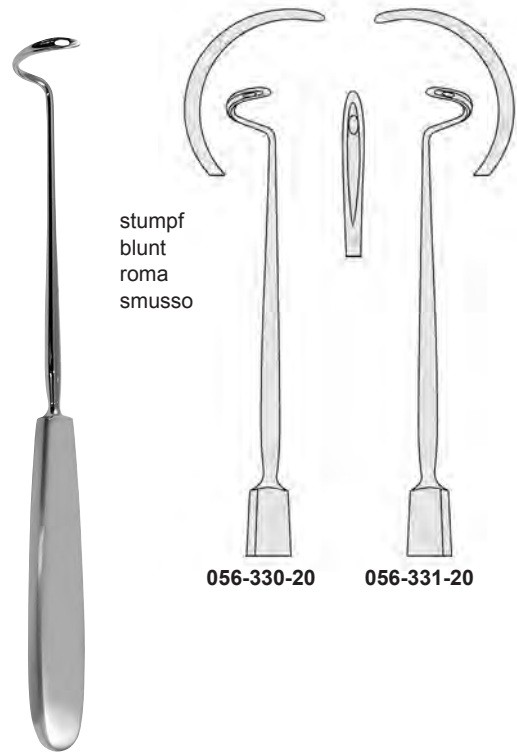

stumpf
blunt
roma
smusso

056-330-20

056-331-20

DESCHAMPS
20,0 cm, 8"



scharf
sharp
aguda
acuto

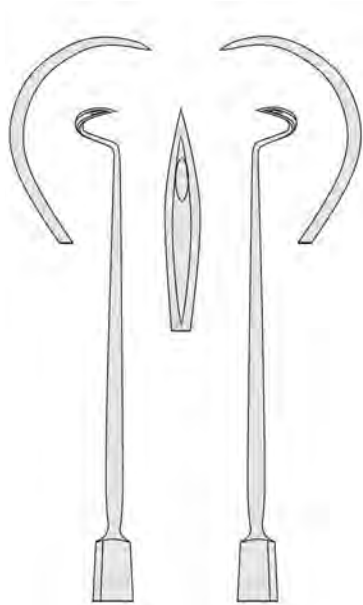

21,0 cm, 8¹/₄" **056-324-21** **056-325-21**
27,0 cm, 10⁵/₈" **056-324-27** **056-325-27**

DESCHAMPS



stumpf
blunt
roma
smusso

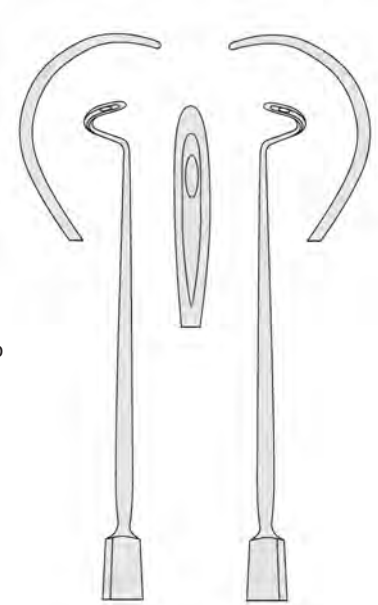

21,0 cm, 8¹/₄" **056-332-21** **056-333-21**
27,0 cm, 10⁵/₈" **056-332-27** **056-333-27**

DESCHAMPS



20,0 cm, 8"
056-450-20



biegsam
malleable
maleable
malleabile

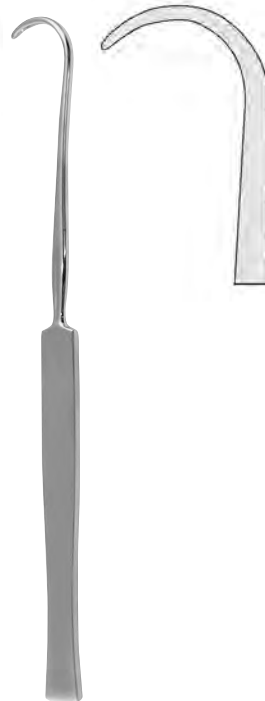

COOPER
19,0 cm, 7¹/₂"
056-451-19



COOPER
20,0 cm, 8"
056-451-20



SYME
15,0 cm, 6"
056-453-15



Ligature Needles



056-452-01



056-452-02



056-452-03



BRUNNER
25,0 cm, 9³/₄"
056-455-25



056-454-01



056-454-02



BRUNNER
30,0 cm, 11³/₄"

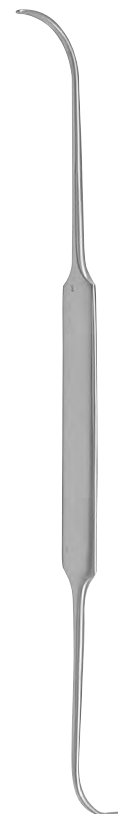

SCHMIEDEN
21,0 cm, 8¹/₄"
056-458-21



YOUNG-HRYNTSCHAK
24,0 cm, 9 1/2"
056-460-24



056-460-01



056-460-02



056-460-03

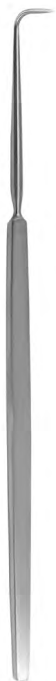

DE LA ROZA
12,0 cm, 4 3/4"
056-467-01



DE LA ROZA
12,0 cm, 4 3/4"
056-467-02



JAKOBI
14,0 cm, 5 1/2"
056-469-14



HESSEBERG
15,0 cm, 6"
056-468-15



KRONECKER
15,0 cm, 6"
056-470-01



KRONECKER
15,0 cm, 6"
056-470-02



TRELAT
23,0 cm, 9"
056-472-23



CLAUS
23,0 cm, 9"
056-473-23



HURD
21,0 cm, 8 1/4"
056-474-01



HURD
21,0 cm, 8 1/4"
056-474-02



NAGER
24,0 cm, 9 1/2"
056-477-24

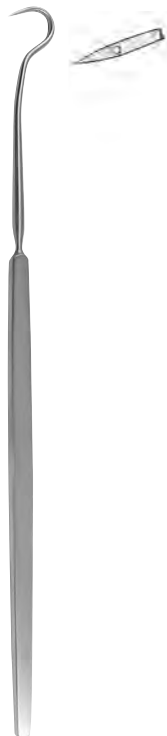

CLAUS-EICKEN
23,0 cm, 9"
056-481-23

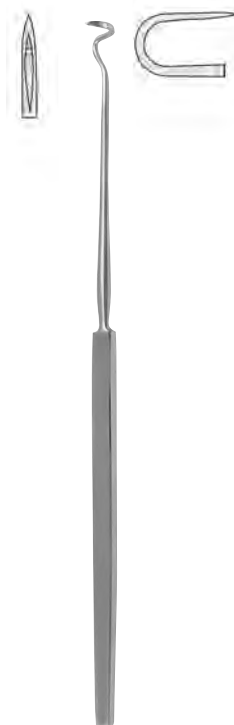

FALK
24,0 cm, 9 1/2"
056-480-01

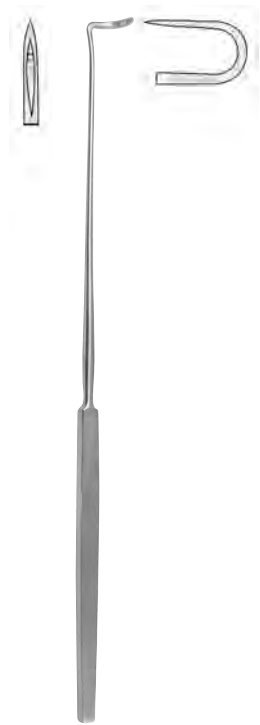

FALK
24,0 cm, 9 1/2"
056-480-02



BRUNNER
30,0 cm, 11³/₄"

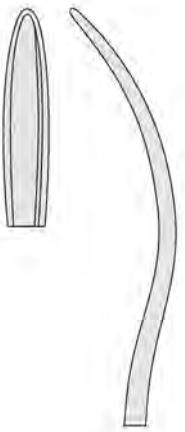

056-500-01

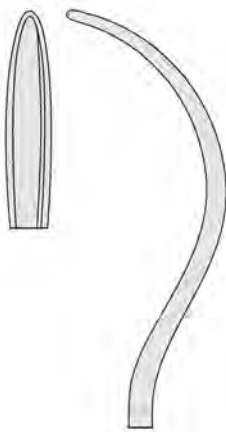

056-500-02



056-500-03

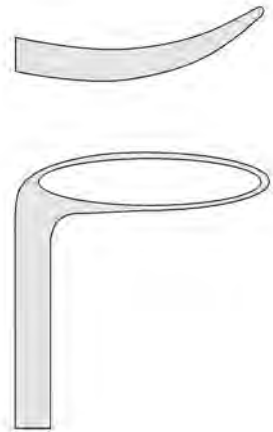

056-500-04



PAYR
22,0 cm, 8⁵/₈"
056-502-22



PAYR
22,0 cm, 8⁵/₈"
056-503-22



mit Loch
with hole
con foro
con ago



SCHMIEDEN-PAYR
19,0 cm, 7¹/₂"
056-506-19



ohne Loch
without hole
sin foro
senza ago



SCHMIEDEN
19,0 cm, 7¹/₂"
056-507-19



KÖNIG
19,5 cm, 7³/₄"
056-508-03



KÖNIG
19,5 cm, 7³/₄"
056-508-05



KÖNIG
19,5 cm, 7³/₄"
056-508-07



KIRSCHNER



25,5 cm, 10"
056-510-25

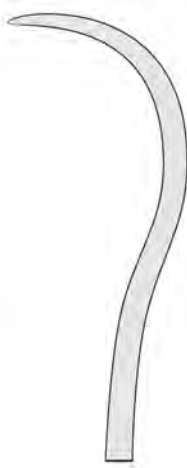

28,0 cm, 11"
056-510-28



BRUNNER-FERROZELL
18,0 cm, 7" **056-521-18**
27,0 cm, 10⁵/₈" **056-521-27**



KOCHER



15,0 cm, 6" **056-513-15** **056-514-15**
16,0 cm, 6¹/₄" **056-513-16** **056-514-16**



18,0 cm, 7"
056-516-18



MOD. WIEN
23,5 cm, 9¹/₄"
056-532-23



BOZEMANN
21,0 cm, 8¹/₄"
056-531-21



23,0 cm, 9"
056-530-23



MICHEL
12,0 cm, 4³/₄"
056-550-12

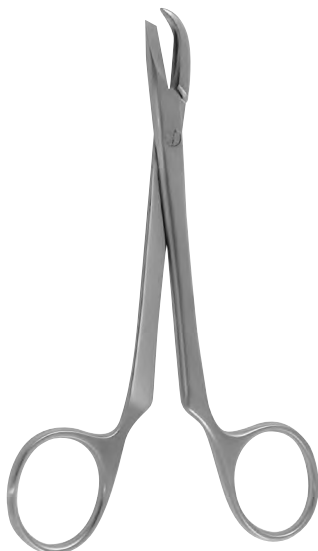

COLLIN
13,0 cm, 5"
056-552-13



RICHTER-HEATH
14,0 cm, 5¹/₂"
056-553-14



WACHENFELDT
12,5 cm, 5"
056-555-01



HEGENBARTH
12,5 cm, 5"
056-556-12



MICHEL
12,0 cm, 4³/₄"
056-558-12



LANGE
10,0 cm, 4"
056-559-10



CHILDE
18,0 cm, 7"
056-560-01



CHILDE CLIP
18,0 cm, 7"
056-560-02



MICHEL

- 056-570-08** 7,5 x 1,75 mm
- 056-570-11** 11,0 x 2,0 mm
- 056-570-12** 12,0 x 3,0 mm
- 056-570-14** 14,0 x 3,0 mm
- 056-570-16** 16,0 x 3,0 mm
- 056-570-18** 18,0 x 3,0 mm
- 056-570-20** 20,0 x 3,0 mm
- 056-570-22** 22,0 x 3,0 mm



CLIP-SET
056-558-00
bestehend aus, consisting of,
compuesto de, composto da
1 x **056-558-12**
1 x **056-550-12**
50 x **056-570-14**
1 x **056-590-01** (Etui)

Retractors

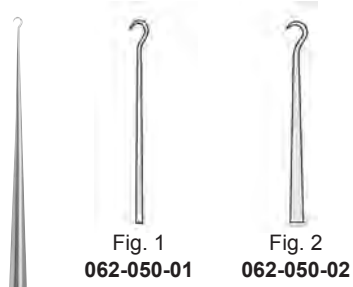

GILLIES
18,0 cm, 7"



KILNER
15,0 cm, 6"
062-054-15



FRAZIER
13,0 cm, 5"
062-060-13



O'CONNOR
16,0 cm, 6 1/4"
062-074-16

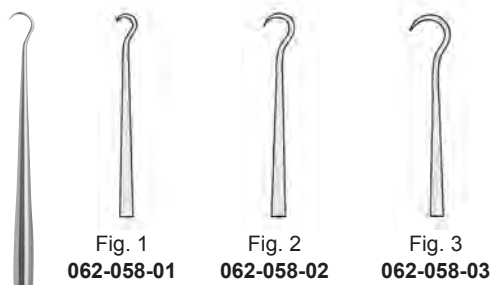

KLEINERT-KUTZ
16,0 cm, 6 1/4"



JOSEPH
16,0 cm, 6 1/4"
062-062-16



GRAEFE
16,0 cm, 6 1/4"





Fig. 1
062-070-01



Fig. 2
062-070-02



Fig. 3
062-070-03



Fig. 4
062-070-04

16,0 cm, 6 1/4"



Fig. 1
062-080-01



Fig. 2
062-080-02



GUTHRIE
16,0 cm, 6 1/4"



Fig. 1
062-086-01



Fig. 2
062-086-02



Fig. 3
062-086-03



Fig. 4
062-086-04



JOSEPH
16,0 cm, 6 1/4"



KNAPP
13,0 cm, 5"



Fig. 1
062-082-01

scharf
sharp
agudos
acuti



Fig. 2
062-082-02

stumpf
blunt
romo
smusso



16,0 cm, 6 1/4"



062-088-02



062-088-03



062-088-04



062-089-02



062-089-03



062-089-04

flexibel · flexible · flexibles · flessibili



16,0 cm, 6 1/4"



062-101-01



062-101-02



062-101-03



062-101-04

scharf
sharp
agudos
acuti



062-103-01



062-103-02



062-103-03



062-103-04

halbscharf
semi-sharp
semi-agudos
semi-acuti



062-102-01



062-102-02



062-102-03



062-102-04

stumpf
blunt
romo
smusso



16,0 cm, 6 1/4"

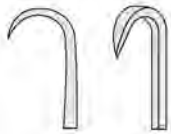

062-111-01



062-111-02



062-111-03

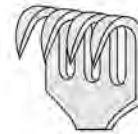

062-111-04

scharf
sharp
agudos
acuti



062-112-01



062-112-02



062-112-03

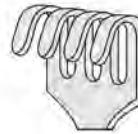

062-112-04

stumpf
blunt
romo
smusso



CUSHING
19,0 cm, 7 1/2"



Fig. 1
062-140-01



Fig. 2
062-140-02

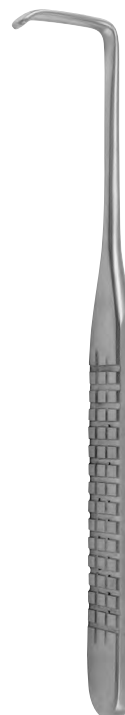

LANGENBECK-GREEN
16,0 cm, 6 1/4"



16 x 6 mm
062-162-01



24 x 6 mm
062-162-02

Retractors



MEYERDING
18,0 cm, 7"



18 x 7 mm
062-150-01



16 x 5 mm
062-150-02



7 x 4 mm
062-150-03



10 x 3 mm
062-150-04



7 x 4 mm
062-150-05



4 x 10 mm
062-150-06



14 x 8 mm
062-166-16



16,0 cm, 6 1/4"



SENN-GREEN
15,0 cm, 6"



10 x 6 mm
062-160-10



20 x 6 mm
062-160-20



MINI-LANGENBECK
16,0 cm, 6 1/4"



10 x 6 mm
062-164-01



17 x 5 mm
062-164-02



20 x 6 mm
062-164-03



22 x 8 mm
062-164-04



RAGNELL-DAVIS
14,0 cm, 5 1/2"
062-170-14



RAGNELL
15,0 cm, 6"
062-174-15

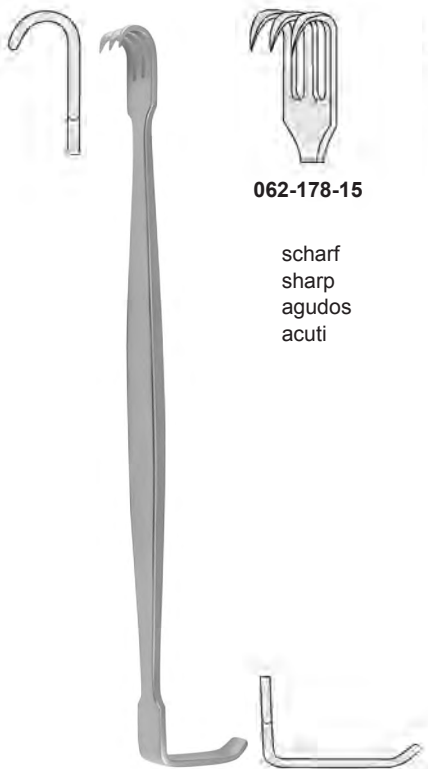

BABY SENN-MILLER
15,0 cm, 6"

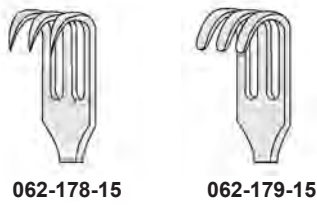

062-178-15

scharf
sharp
agudos
acuti



062-179-15

stumpf
blunt
romo
smusso

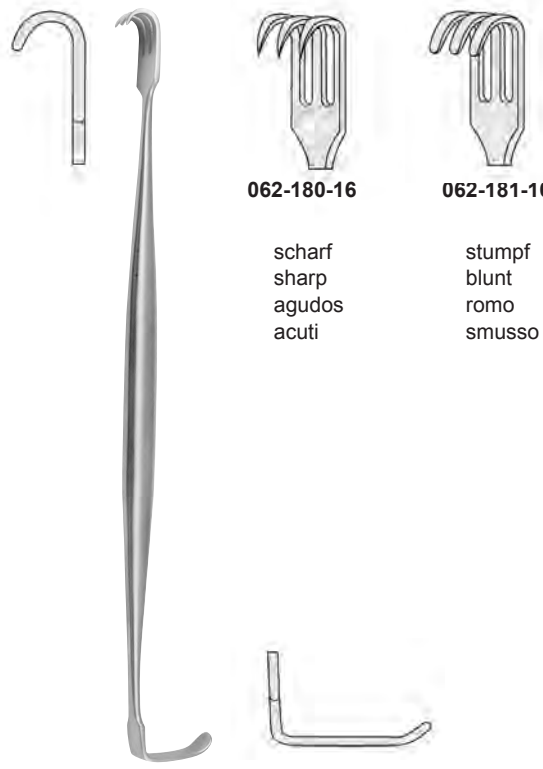

SENN-MILLER
16,0 cm, 6 1/4"



062-180-16

scharf
sharp
agudos
acuti



062-181-16

stumpf
blunt
romo
smusso

Retractors



DESMARRES
13,0 cm, 5"

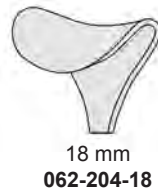

DESMARRES
16,0 cm, 6 1/4"



CUSHING
20,0 cm, 8"



8 mm
062-210-08



10 mm
062-210-10



12 mm
062-210-12



14 mm
062-210-14



16 mm
062-210-16



18 mm
062-210-18



CUSHING
24,0 cm, 9 1/2"



8 mm
062-212-08



10 mm
062-212-10



12 mm
062-212-12



14 mm
062-212-14



16 mm
062-212-16



18 mm
062-212-18



GIL-VERNET
24,0 cm, 9 1/2"



8 mm
062-220-08



11 mm
062-220-11



13 mm
062-220-13



17 mm
062-220-17



20 mm
062-220-20



23 mm
062-220-23



GIL-VERNET
24,0 cm, 9 1/2"



8 mm
062-230-08



11 mm
062-230-11



13 mm
062-230-13



17 mm
062-230-17



20 mm
062-230-20



23 mm
062-230-23



Fig. 1 24 x 20 mm
 Fig. 2 29 x 26 mm
 Fig. 3 33 x 29 mm
 Fig. 4 29 x 24 mm

Satz, Fig. 1-3
 Set, fig. 1-3
 Juego, fig. 1-3
 Serie, fig. 1-3

Fig. 1 30 x 28 mm
 Fig. 2 36 x 36 mm
 Fig. 3 38 x 43 mm
 Fig. 4 45 x 28 mm

ROUX

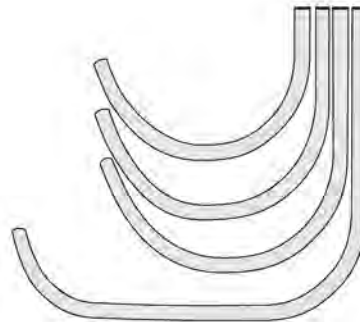
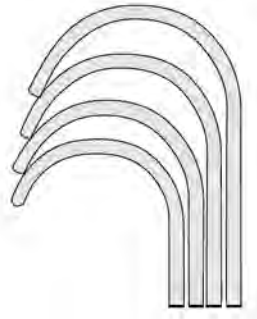

Fig. 1-3	17,0 cm, 6 ³ / ₄ "	062-310-00
Fig. 1	14,0 cm, 5 ¹ / ₂ "	062-310-01
Fig. 2	15,0 cm, 6"	062-310-02
Fig. 3	17,0 cm, 6 ³ / ₄ "	062-310-03
Fig. 4	18,0 cm, 7"	062-310-04



Fig. 2 30 x 10 mm
 Fig. 1 26 x 10 mm

Fig. 1 30 x 13 mm
 Fig. 2 34 x 13 mm

FARABEUF
 12,0 cm, 4³/₄"
062-300-12

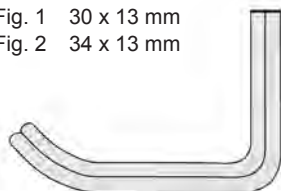
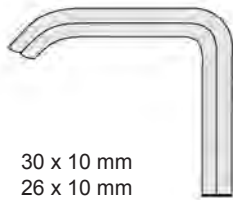
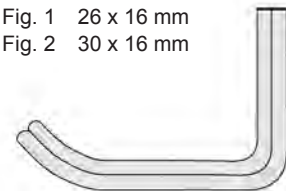
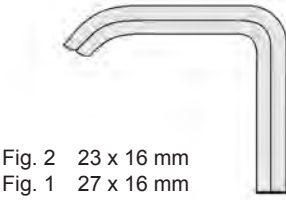
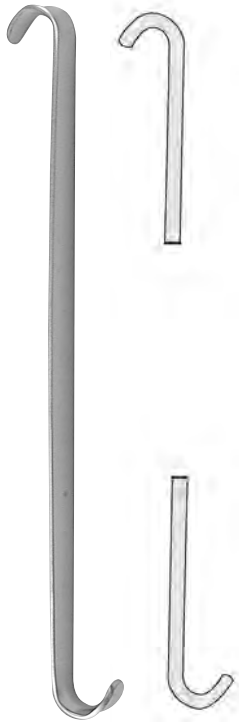

Fig. 2 23 x 16 mm
 Fig. 1 27 x 16 mm

Fig. 1 26 x 16 mm
 Fig. 2 30 x 16 mm

FARABEUF
 15,0 cm, 5³/₄"
062-302-15





MINI-ROUX
14,0 cm, 5¹/₂"
062-340-06



BABY-ROUX
13,0 cm, 5"
062-342-13

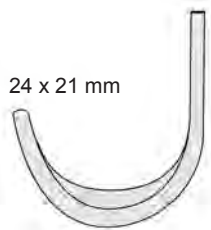

PARKER
13,5 cm, 5³/₈"
062-350-00

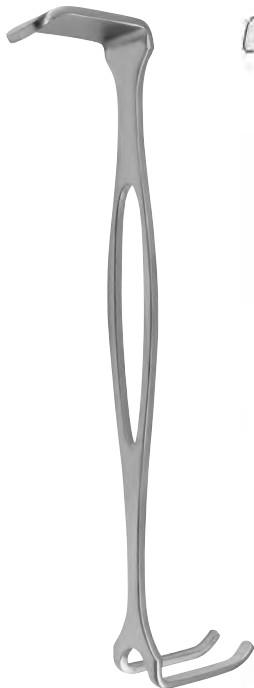
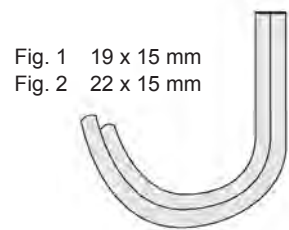
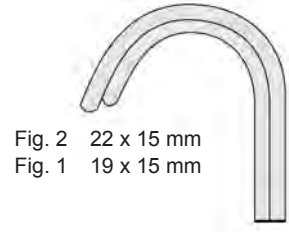

CZERNY
17,5 cm, 7"
062-360-00



MATHIEU
20,0 cm, 8"
062-380-00

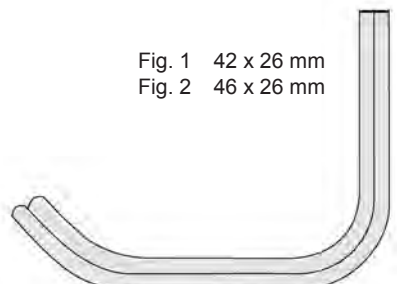
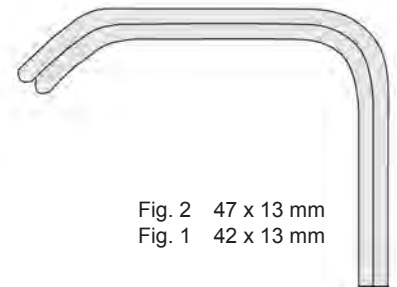

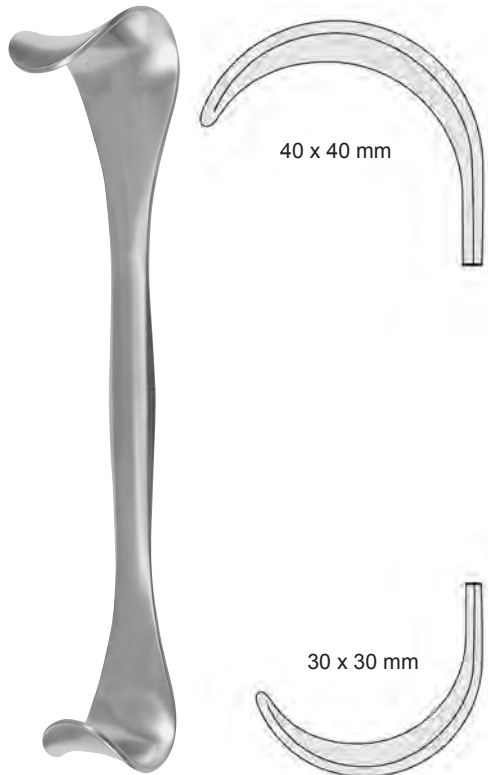

GOELET
19,0 cm, 7½"
062-396-19

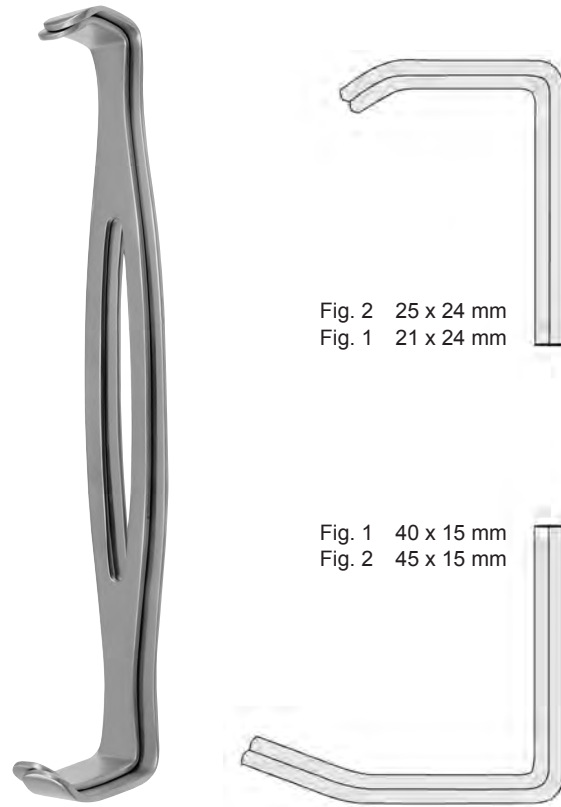

PARKER-LANGENBECK
21,0 cm, 8¼"
062-390-00

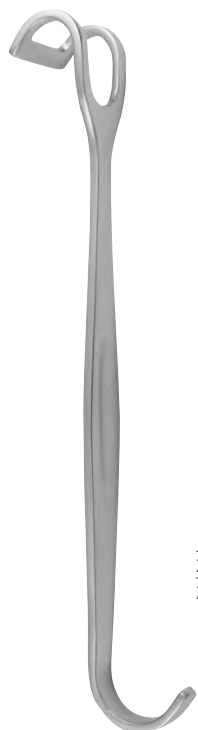

16 mm	19,0 cm, 7½"	062-370-16
20 mm	19,0 cm, 7½"	062-370-20
25 mm	20,0 cm, 8"	062-370-25

CANNY RYAL



VOLKMANN
21,5 cm, 8½"

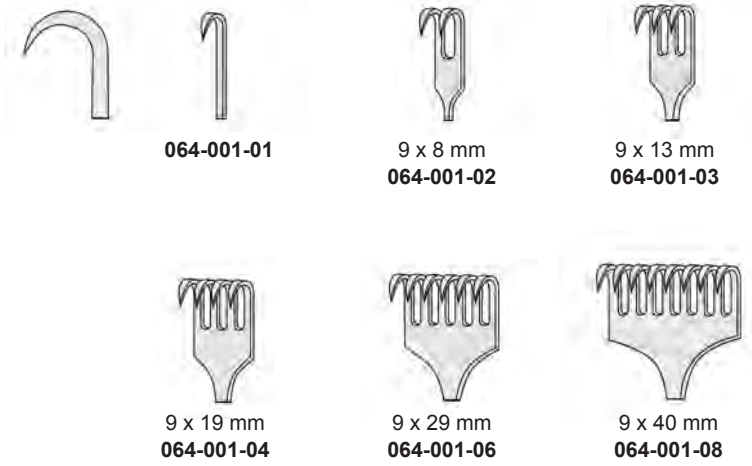

scharf
sharp
agudos
acuti



VOLKMANN
21,5 cm, 8½"

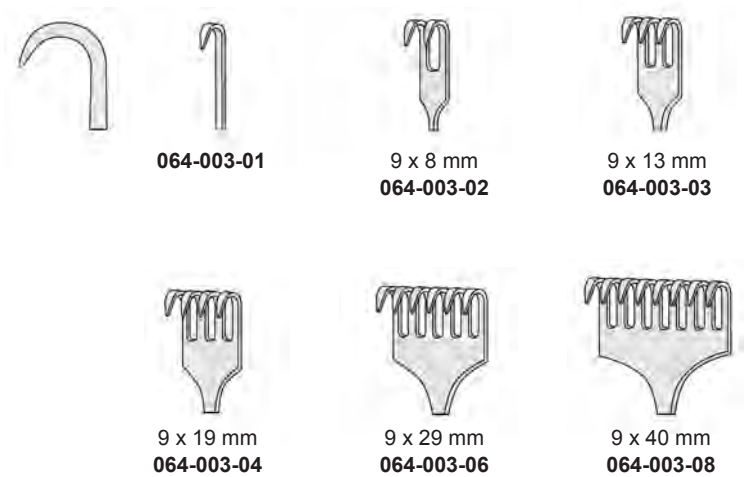

halbscharf
semi-sharp
semi-agudos
semi-acuti



VOLKMANN
21,5 cm, 8½"



064-002-01



9 x 8 mm
064-002-02



9 x 13 mm
064-002-03



9 x 19 mm
064-002-04



9 x 29 mm
064-002-06



9 x 40 mm
064-002-08

stumpf
blunt
romo
smusso



KOCHER
22,0 cm, 8⅝"



064-011-01



9 x 8 mm
064-011-02



15 x 15 mm
064-011-03



15 x 20 mm
064-011-04

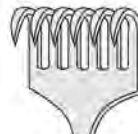

15 x 30 mm
064-011-06



15 x 40 mm
064-011-08

scharf
sharp
agudos
acuti

Retractors



KOCHER
22,0 cm, 8⁵/₈"

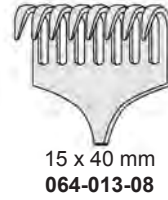
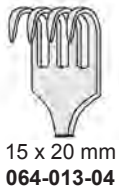

halbscharf
semi-sharp
semi-agudos
semi-acuti



KOCHER
22,0 cm, 8⁵/₈"

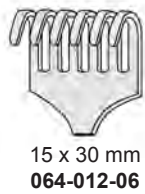

stumpf
blunt
romo
smusso

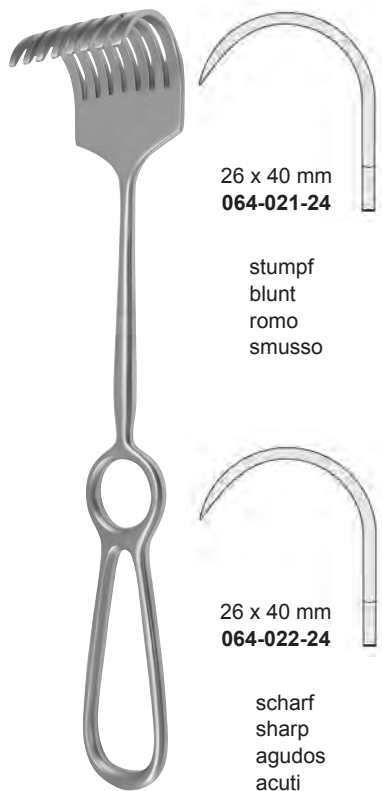

26 x 40 mm
064-021-24

stumpf
blunt
romo
smusso

26 x 40 mm
064-022-24

scharf
sharp
agudos
acuti

KOERTE
24,0 cm, 9¹/₂"

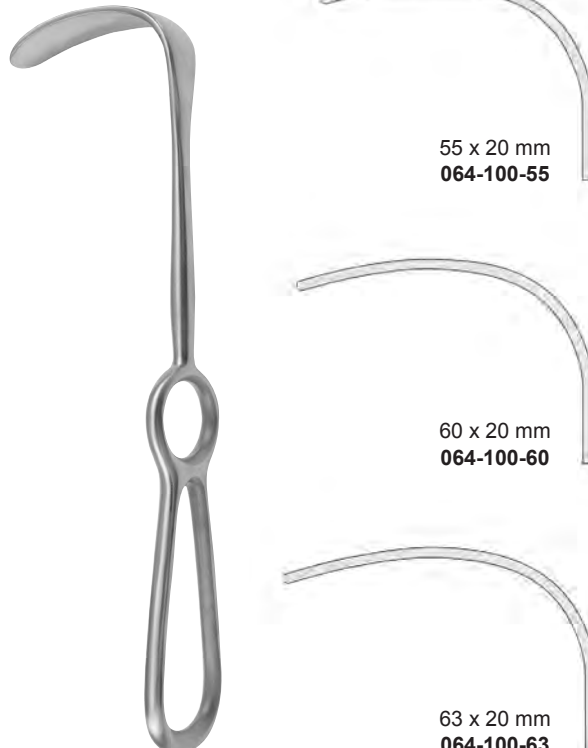

55 x 20 mm
064-100-55

60 x 20 mm
064-100-60

63 x 20 mm
064-100-63

LANGENBECK
21,0 cm, 8¹/₄"



ISRAEL
25,0 cm, 9³/₄"

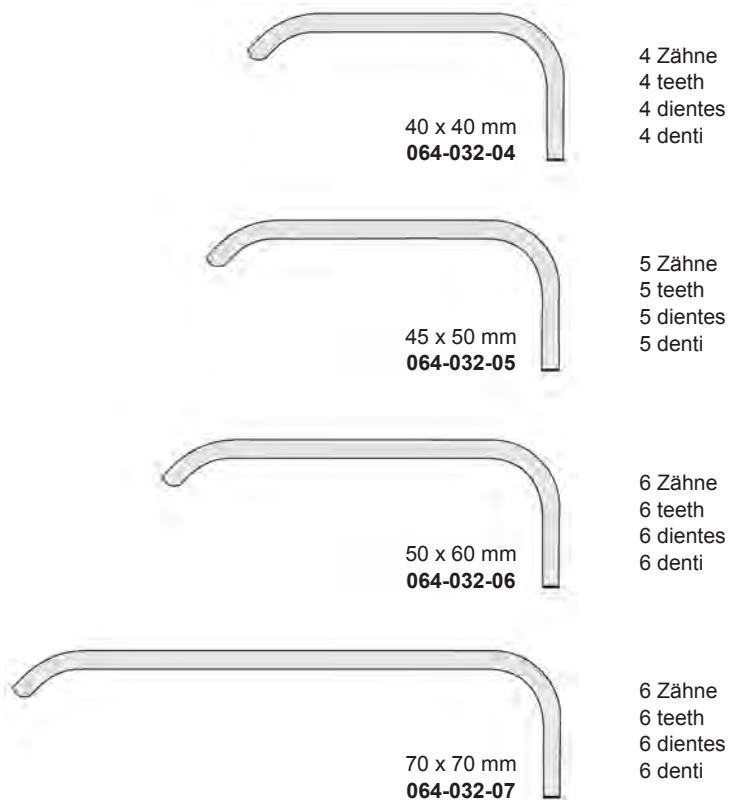

40 x 40 mm
064-032-04

4 Zähne
4 teeth
4 dientes
4 denti

45 x 50 mm
064-032-05

5 Zähne
5 teeth
5 dientes
5 denti

50 x 60 mm
064-032-06

6 Zähne
6 teeth
6 dientes
6 denti

70 x 70 mm
064-032-07

6 Zähne
6 teeth
6 dientes
6 denti



LANGENBECK
22,0 cm, 8⁵/₈"



30 x 11 mm
064-110-30



30 x 14 mm
064-110-31



30 x 16 mm
064-110-32



40 x 11 mm
064-110-40



50 x 11 mm
064-110-50



LANGENBECK
22,0 cm, 8⁵/₈"



30 x 11 mm
064-120-30



30 x 14 mm
064-120-31



30 x 16 mm
064-120-32



40 x 11 mm
064-120-40



50 x 11 mm
064-120-50



KOCHER-LANGENBECK
21,5 cm, 8½"



22 x 6 mm
064-130-22



25 x 6 mm
064-130-25



25 x 8 mm
064-130-26



35 x 8 mm
064-130-35



35 x 11 mm
064-130-36



35 x 15 mm
064-130-37



40 x 11 mm
064-130-40



70 x 14 mm
064-130-70



80 x 12 mm
064-130-80



80 x 16 mm
064-130-85



KOCHER
23,0 cm, 9"

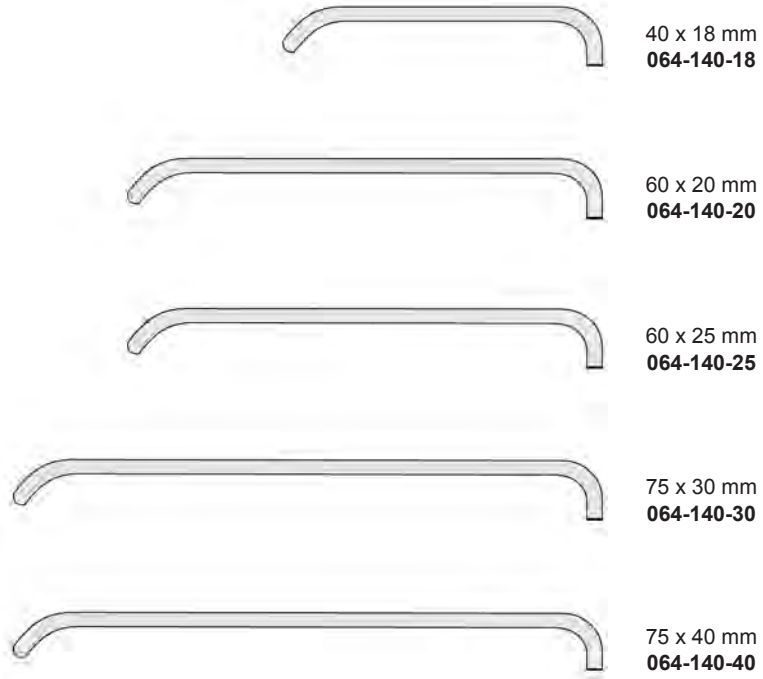

SAUERBRUCH
22,5 cm, 8³/₄"

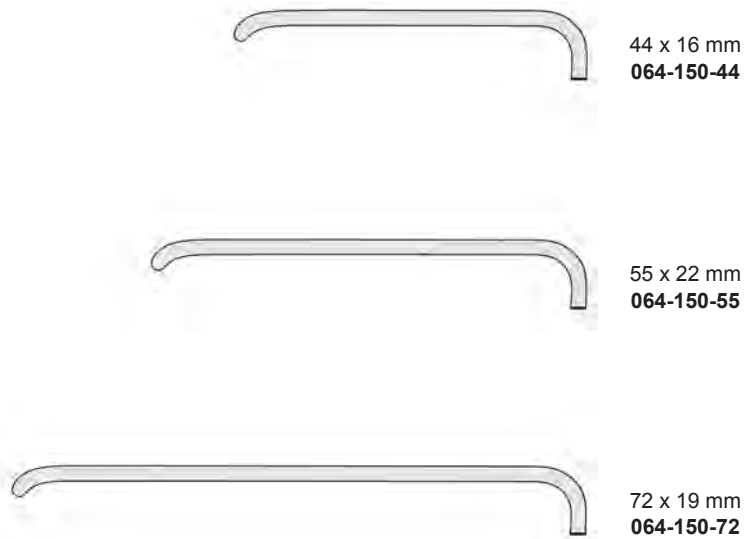



MIDDELDORPF



21,5 cm, 8½"
14 x 17 mm
064-180-01



22,0 cm, 8⅝"
20 x 22 mm
064-180-02



23,5 cm, 9¼"
26 x 30 mm
064-180-03



MIDDELDORPF



21,5 cm, 8½"
14 x 17 mm
064-182-01



22,0 cm, 8⅝"
20 x 22 mm
064-182-02



23,5 cm, 9¼"
26 x 30 mm
064-182-03



RICHARDSON (KELLY)
24,0 cm, 9½"



28 x 20 mm
064-210-02

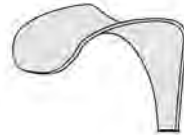

36 x 28 mm
064-210-03

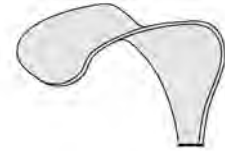

44 x 38 mm
064-210-04



52 x 22 mm
064-210-05

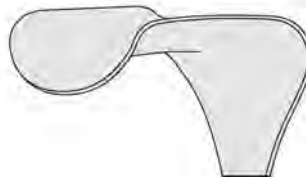

65 x 50 mm
064-210-06

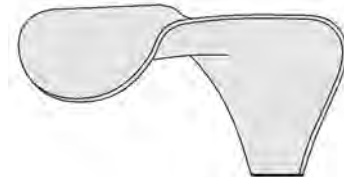

70 x 65 mm
064-210-07

Retractors

49 x 38 mm

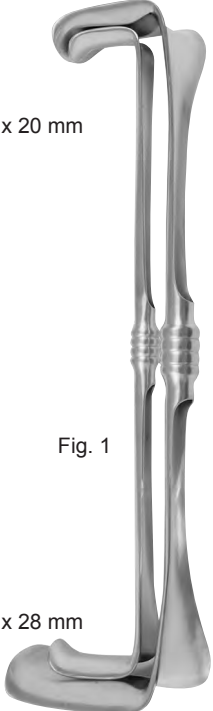

28 x 20 mm

Fig. 2

Fig. 1

36 x 28 mm

63 x 49 mm

RICHARDSON-EASTMAN

Fig. 1+2	28,0 cm, 11"	062-200-00
Fig. 1	26,0 cm, 10 ¹ / ₄ "	062-200-01
Fig. 2	28,0 cm, 11"	062-200-02



MIDDELDORPF
25,5 cm, 10"



40 x 45 mm	064-192-01
45 x 50 mm	064-192-02
55 x 70 mm	064-192-03



FRITSCH
24,0 cm, 9¹/₂"



45 x 40 mm	064-240-40
45 x 50 mm	064-240-50
45 x 60 mm	064-240-60
55 x 75 mm	064-240-75
65 x 85 mm	064-240-85



50 x 85 mm

DOYEN
25,0 cm, 10"
064-230-50

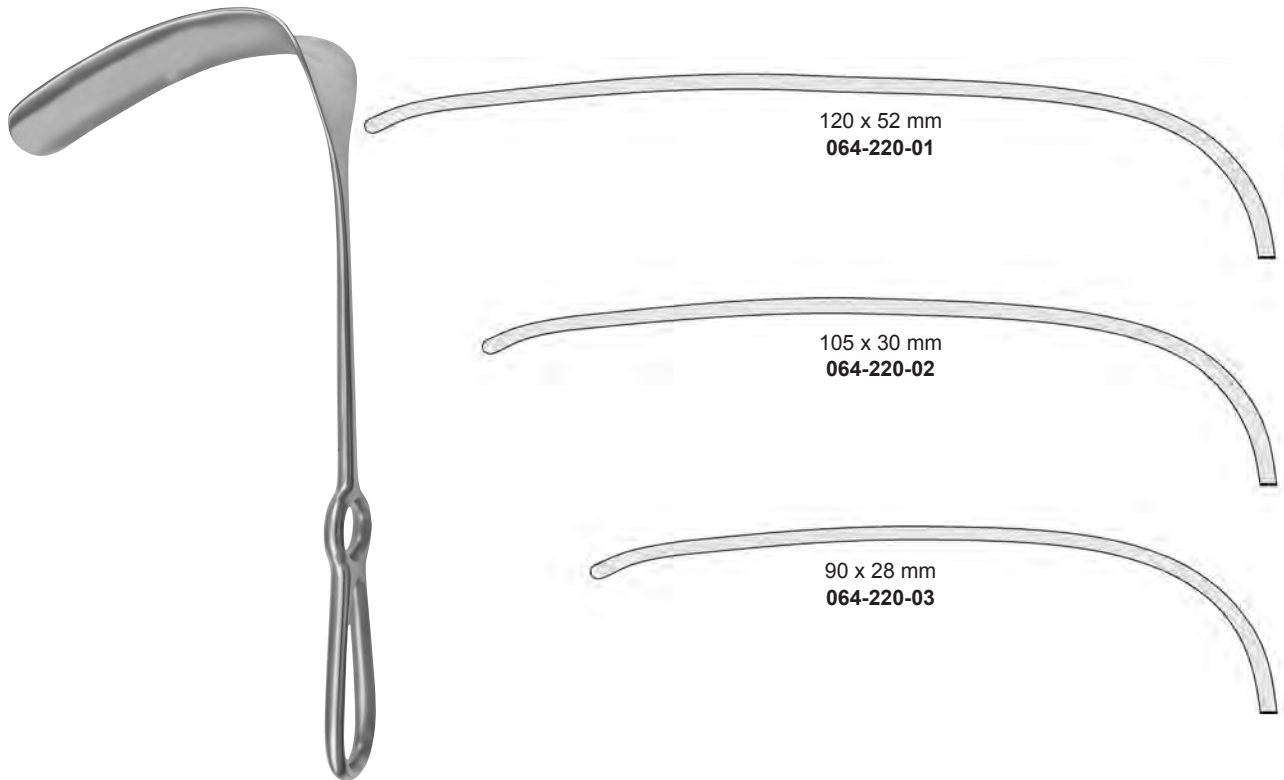

120 x 52 mm
064-220-01

105 x 30 mm
064-220-02

90 x 28 mm
064-220-03

DOYEN-STILLE
22,0 cm, 8⁵/₁₆"

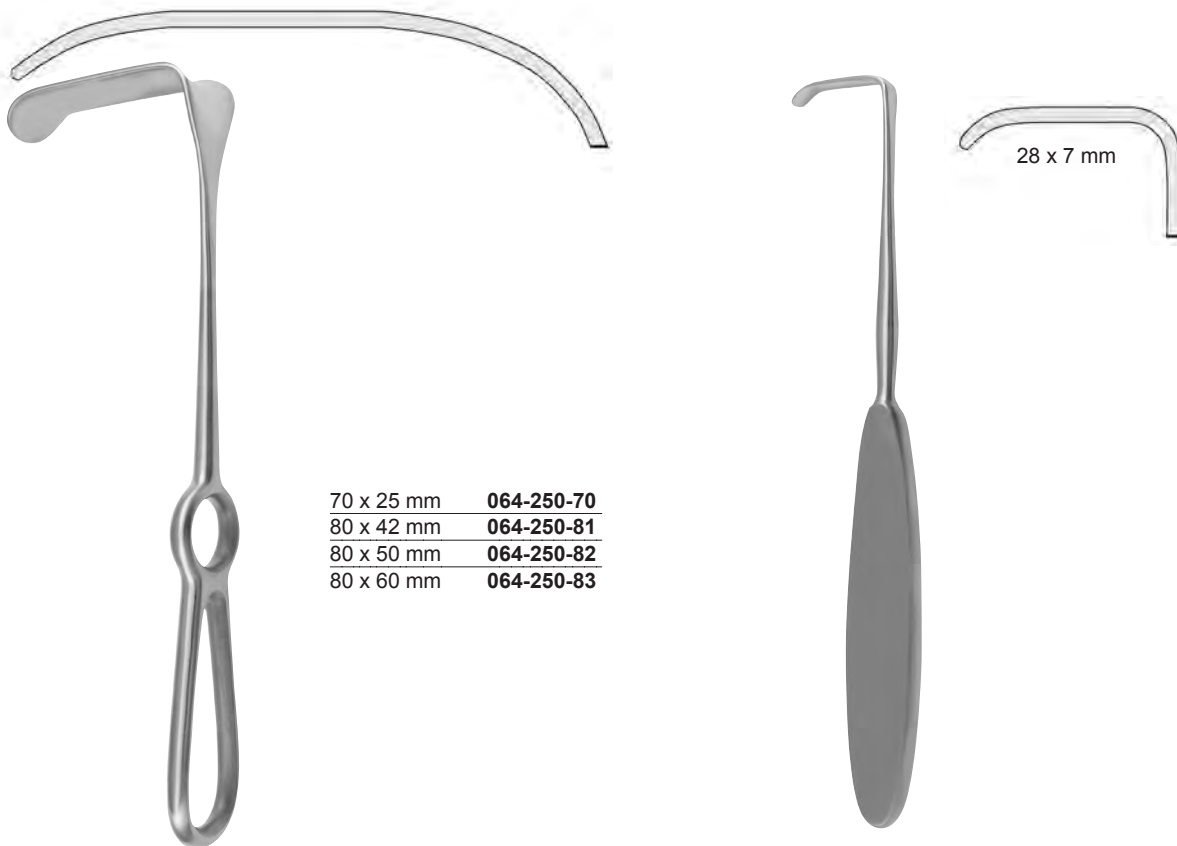

28 x 7 mm

70 x 25 mm	064-250-70
80 x 42 mm	064-250-81
80 x 50 mm	064-250-82
80 x 60 mm	064-250-83

KOCHER
25,0 cm, 10"

LAHEY
19,0 cm, 7¹/₂"
061-160-19

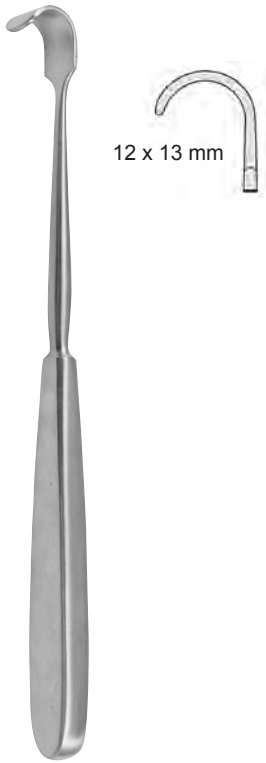

LITTLE
20,0 cm, 8"
064-164-20



SIMON
28,0 cm, 11"
115 x 22 mm **064-260-01**
115 x 27 mm **064-260-02**

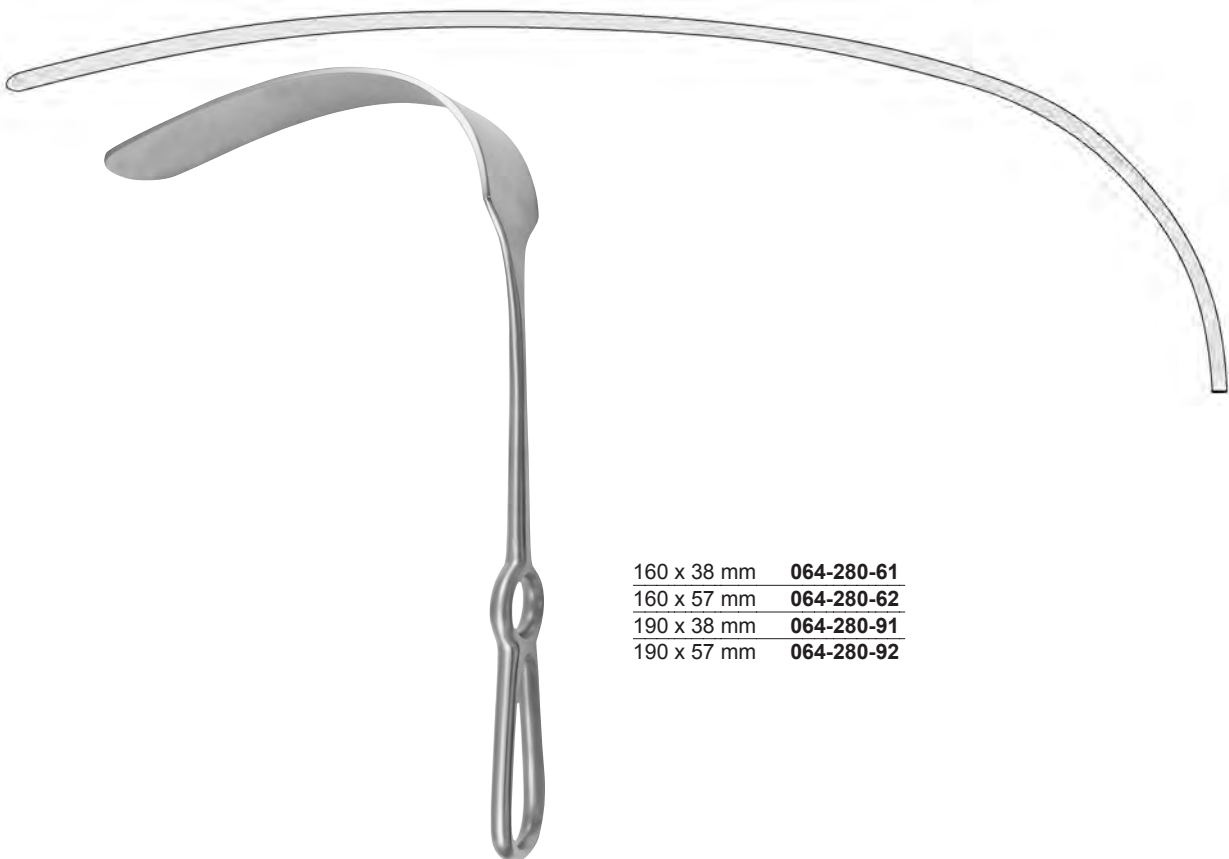

KELLY
27,0 cm, 10¹/₂"

160 x 38 mm **064-280-61**
160 x 57 mm **064-280-62**
190 x 38 mm **064-280-91**
190 x 57 mm **064-280-92**



85 x 35 mm	064-274-01
120 x 50 mm	064-274-02
150 x 50 mm	064-274-03

MIKULICZ
26,0 cm, 10¹/₄"



90 x 50 mm

MIKULICZ
26,0 cm, 10¹/₄"
064-272-90

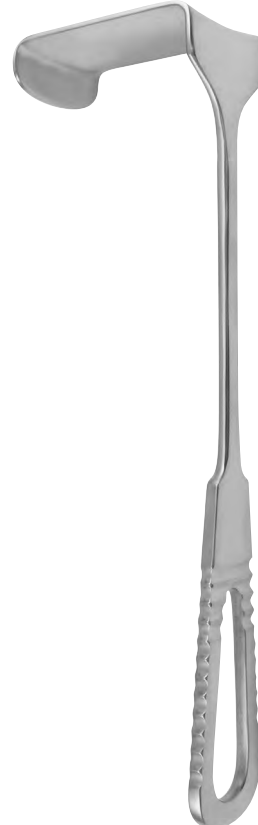

70 x 38 mm	064-290-38
70 x 50 mm	064-290-51

MORRIS
24,5 cm, 9⁵/₈"

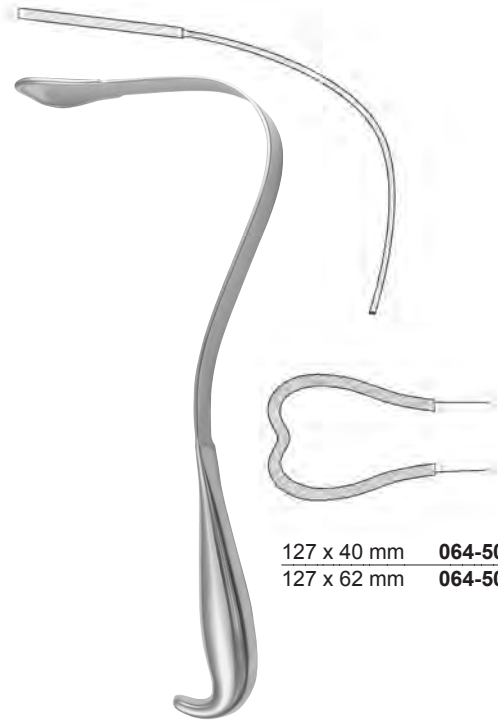

127 x 40 mm **064-500-40**
 127 x 62 mm **064-500-62**

HARRINGTON
 32,0 cm, 12½"



82 x 22 mm **064-390-01**
 108 x 43 mm **064-390-02**
 115 x 65 mm **064-390-03**

CORYKKOS
 24,0 cm, 9½"

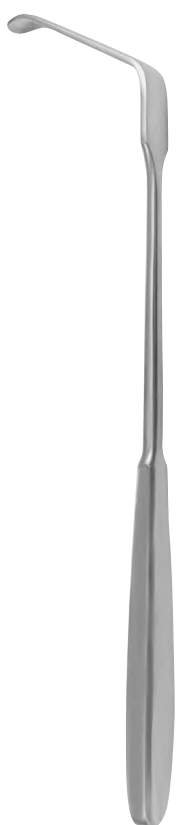

ZENKER

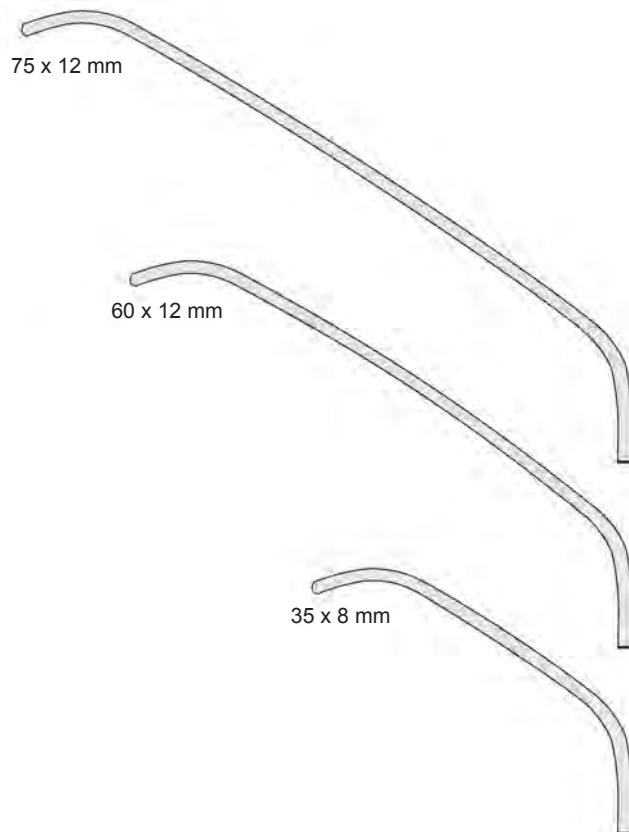

75 x 12 mm

60 x 12 mm

35 x 8 mm

25,0 cm, 9¾"
064-320-25

26,0 cm, 10¼"
064-320-26

27,5 cm, 10¾"
064-320-27



MEYERDING
22,5 cm, 8³/₄"

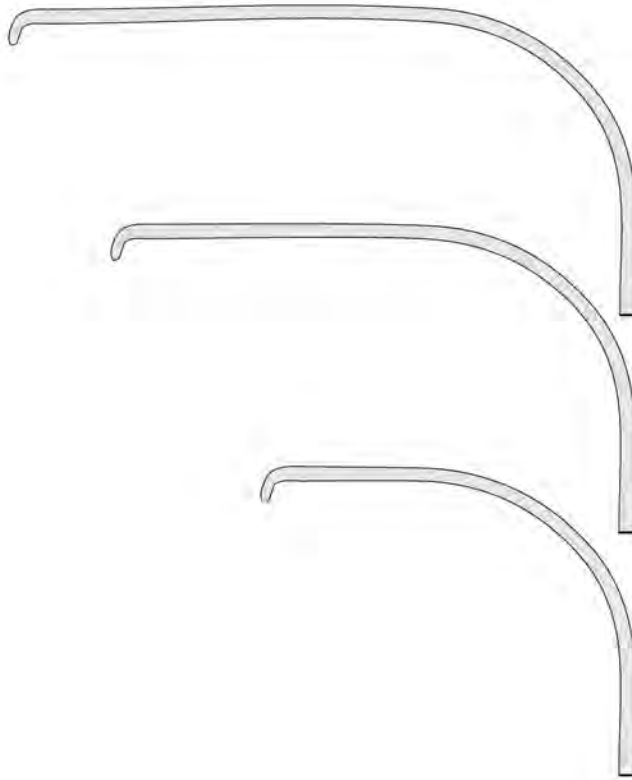

90 x 50 mm
064-350-50

75 x 25 mm
064-350-25

50 x 16 mm
064-350-16



BRUNNER
25,0 cm, 10"

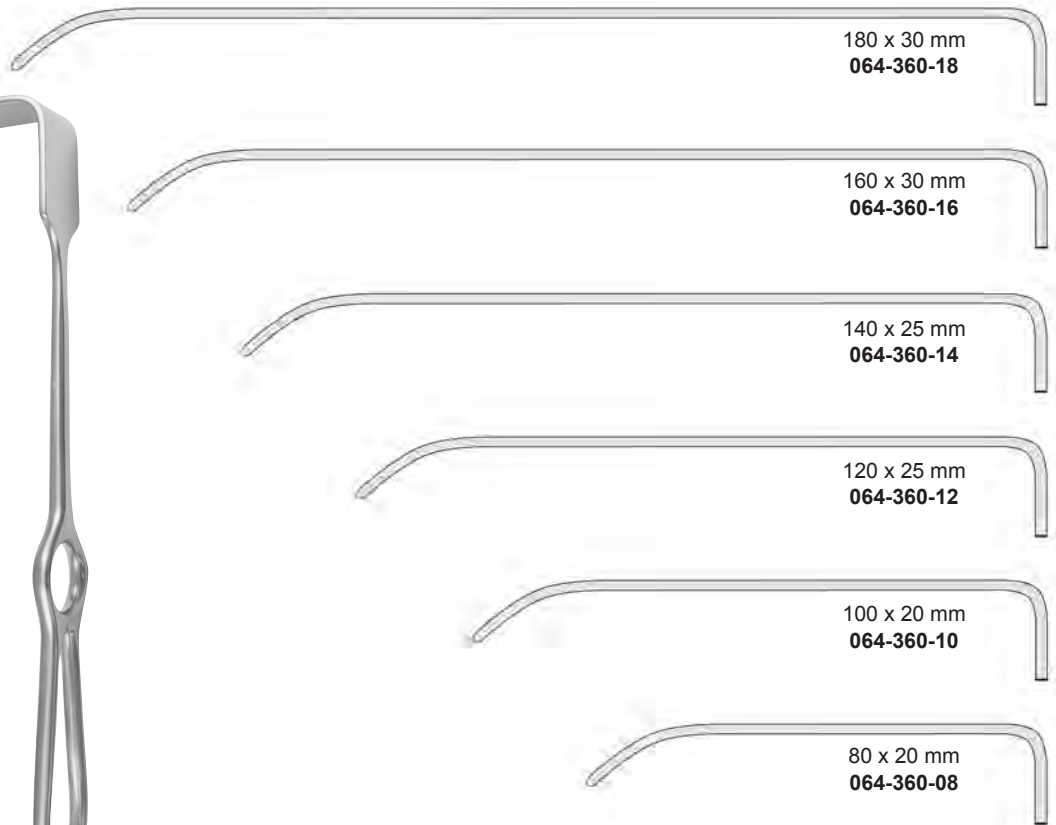

180 x 30 mm
064-360-18

160 x 30 mm
064-360-16

140 x 25 mm
064-360-14

120 x 25 mm
064-360-12

100 x 20 mm
064-360-10

80 x 20 mm
064-360-08



BRUNNER
25,0 cm, 10"

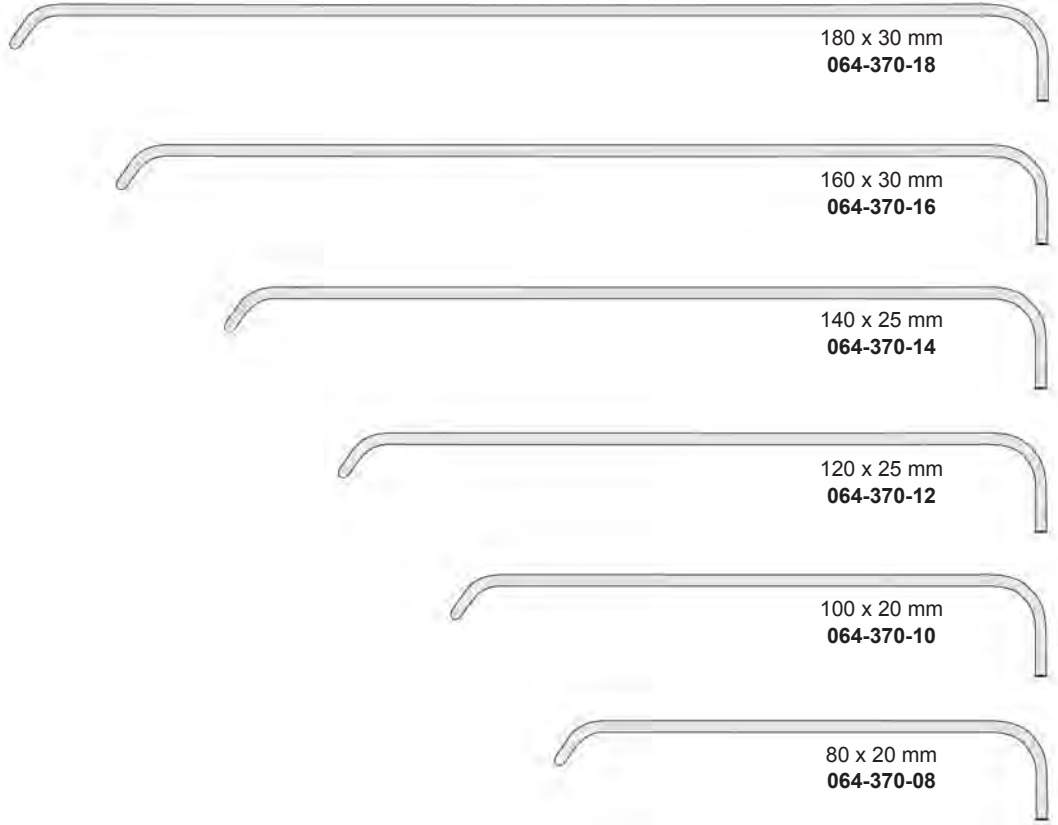

DEAVER
18,0 cm, 7"
064-602-18



DEAVER
21,5 cm, 8½"
064-602-22

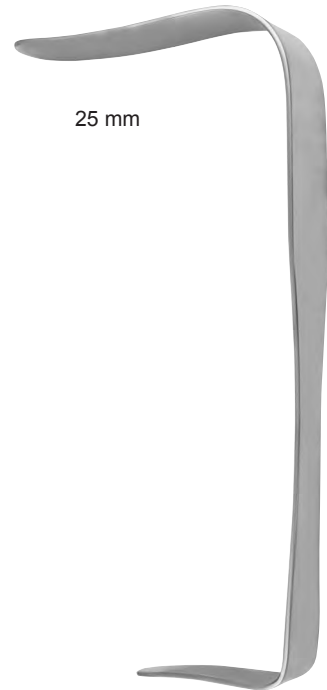

DEAVER
23,0 cm, 9"
064-602-23

25 mm



DEAYER
30,0 cm, 11³/₄"
064-604-30

25 mm



DEAYER
33,0 cm, 13"
064-604-33

25 mm

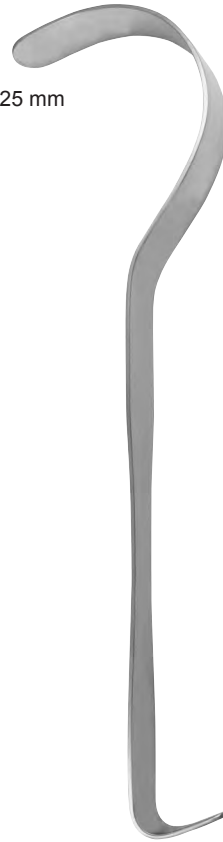

DEAYER
36,0 cm, 14¹/₈"
064-604-36

38 mm



DEAYER
30,0 cm, 11³/₄"
064-610-38

50 mm



DEAYER
30,0 cm, 11³/₄"
064-610-50

75 mm



DEAYER
30,0 cm, 11³/₄"
064-610-75

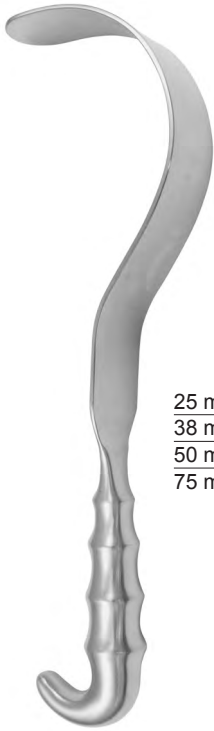

25 mm **064-600-25**
 38 mm **064-600-38**
 50 mm **064-600-50**
 75 mm **064-600-75**

DEAVER
 30,0 cm, 11³/₄"



ALLISON
 40 mm 30,0 cm, 11³/₄" **064-700-30**
 54 mm 32,0 cm, 12¹/₂" **064-700-32**



DAVIDSON
 75 x 50 mm 16,0 cm, 6¹/₄" **064-710-50**
 75 x 90 mm 16,0 cm, 6¹/₄" **064-710-90**



ST MARKS

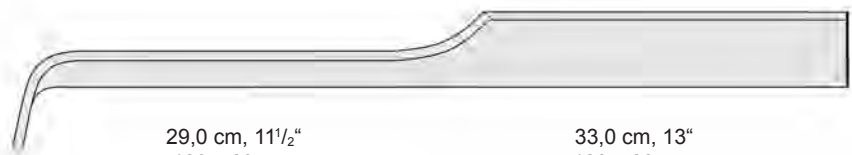

29,0 cm, 11¹/₂"
 130 x 60 mm
064-720-01

33,0 cm, 13"
 180 x 60 mm
064-720-02



29,0 cm, 11¹/₂"
 130 x 60 mm
064-721-01

33,0 cm, 13"
 180 x 60 mm
064-721-02

Self-Retaining Retractors

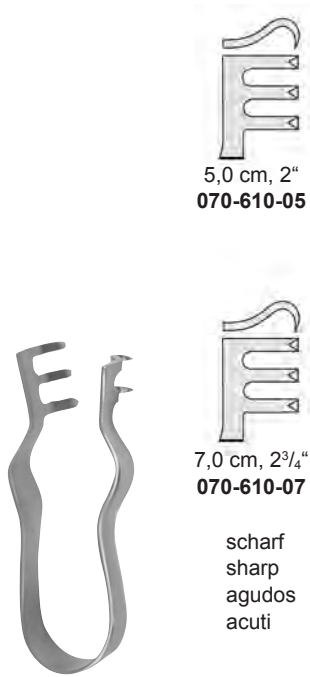

FINSEN



scharf
sharp
agudos
acuti



stumpf
blunt
romo
smusso



JANSEN
10,0 cm, 4"

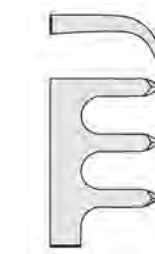

scharf
sharp
agudos
acuti

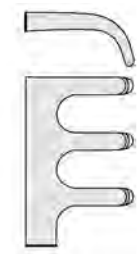

stumpf
blunt
romo
smusso



ALM

scharf halbscharf stumpf
sharp semi-sharp blunt
agudos semi-agudos romo
acuti semi-acuti smusso



7,0 cm, 2³/₄" **070-620-07** **070-622-07** **070-621-07**
10,0 cm, 4" **070-620-10** **070-622-10** **070-621-10**



ALLPORT
9,5 cm, 3³/₄"
070-626-09

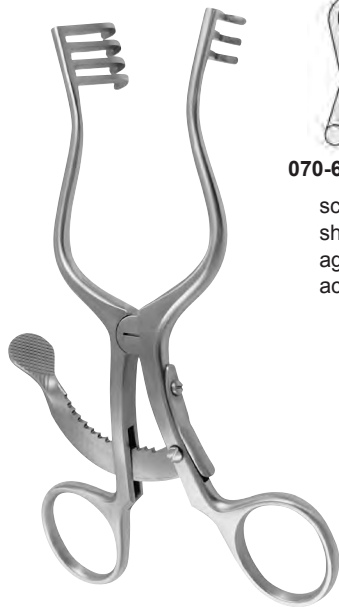

SALP-CONTOUR
14,0 cm, 5½"



ADSON-BABY
16,0 cm, 6¼"



ANDERSON-ADSON
19,0 cm, 8"



ADSON
26,5 cm, 10½"

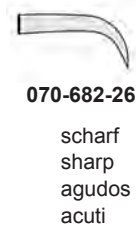

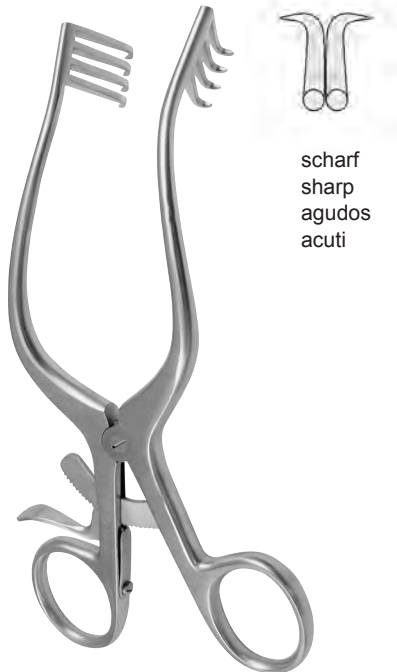

scharf
sharp
agudos
acuti

MOLLISON
15,5 cm, 6"
070-674-15



070-800-12

scharf
sharp
agudos
acuti



070-801-12

stumpf
blunt
romo
smuss

SCHUHKNECHT
12,5 cm, 5"

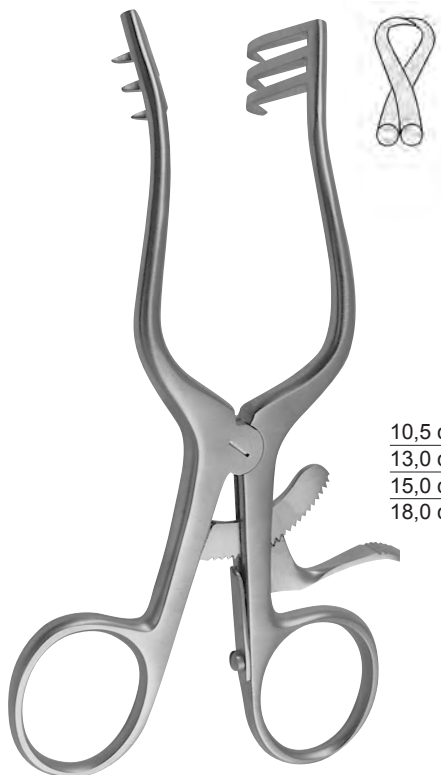

scharf stumpf
sharp blunt
agudos romo
acuti smusso

10,5 cm, 4 ¹ / ₈ "	070-810-10	070-811-10
13,0 cm, 5"	070-810-13	070-811-13
15,0 cm, 6"	070-810-15	070-811-15
18,0 cm, 7"	070-810-18	070-811-18

WULLSTEIN

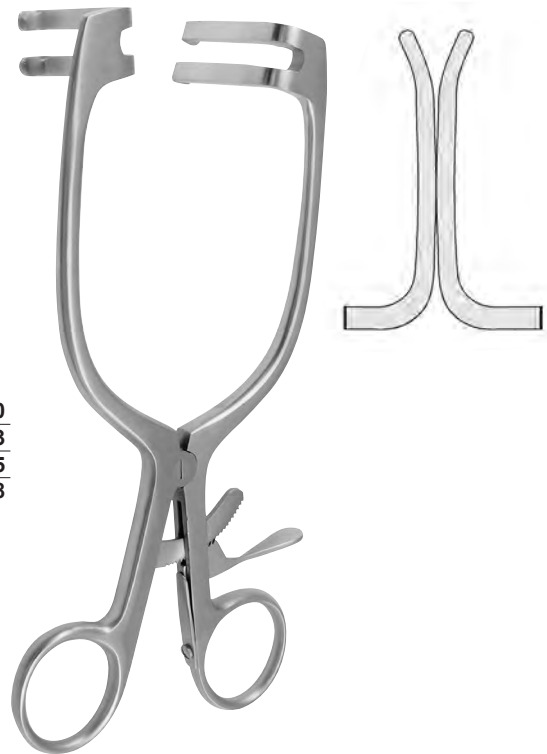

MAYO-ADAMS
16,5 cm, 6¹/₂"
070-822-17

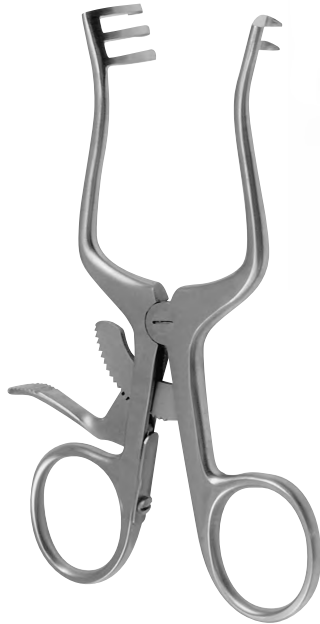

WEITLANER-LOKTITE
10,5 cm, 4 1/8"



070-650-10
scharf
sharp
agudos
acuti



070-651-10
stumpf
blunt
romo
smusso

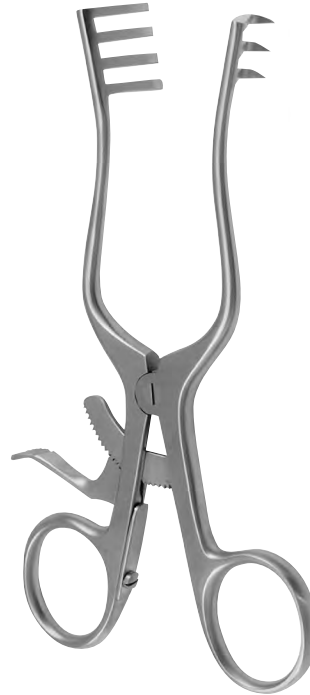

WEITLANER
13,0 cm, 5"



070-670-13
scharf
sharp
agudos
acuti



070-671-13
stumpf
blunt
romo
smusso



WEITLANER
16,5 cm, 6 1/2"



070-670-16
scharf
sharp
agudos
acuti



070-671-16
stumpf
blunt
romo
smusso



WEITLANER
20,0 cm, 8"



070-670-20
scharf
sharp
agudos
acuti



070-671-20
stumpf
blunt
romo
smusso



WEITLANER
24,0 cm, 9½"



070-670-24

scharf
sharp
agudos
acuti



070-671-24

stumpf
blunt
romo
smusso



PLESTER
13,0 cm, 5"



070-830-13

scharf
sharp
agudos
acuti



070-831-13

stumpf
blunt
romo
smusso



MILLIGAN
13,0 cm, 5"
070-840-13

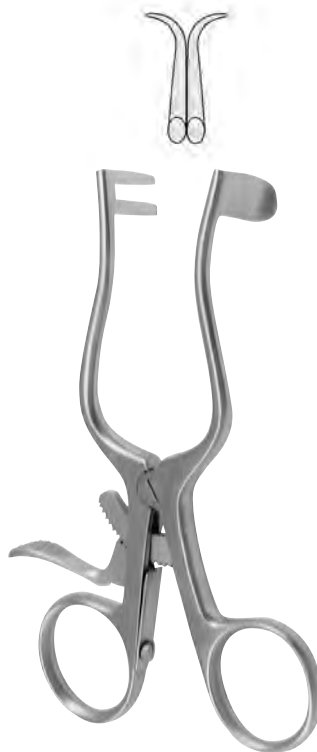
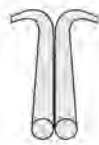

PLESTER
11,0 cm, 4¾"
070-672-11



PLESTER
11,0 cm, 4¾"
070-673-11



WEITLANER-BABY
13,0 cm, 5"
070-850-13

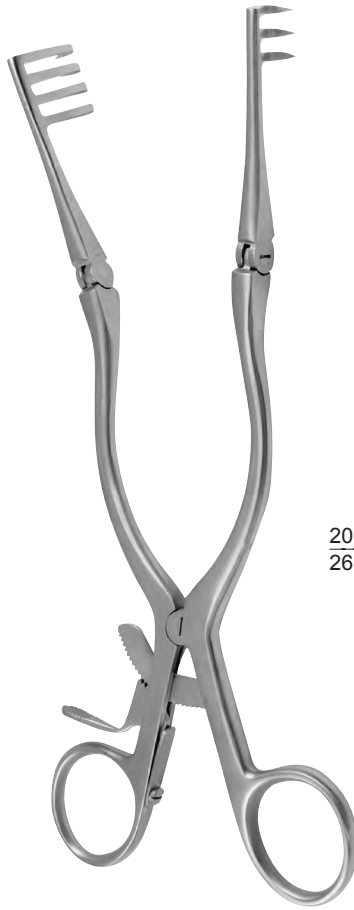

**ADSON
(CONE)**

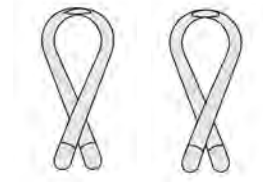

20,0 cm, 8" **070-860-20** **070-861-20**
26,0 cm, 10¹/₄" **070-860-26** **070-861-26**

scharf	stumpf
sharp	blunt
agudos	romo
acuti	smusso

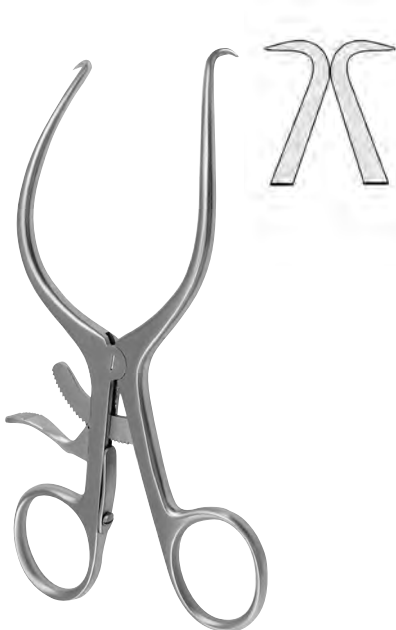

GELPI
13,5 cm, 5³/₈"
070-202-14



GELPI
19,0 cm, 7¹/₂"
070-202-19



GELPI-LOKTITE
18,0 cm, 7¹/₂"
070-250-19

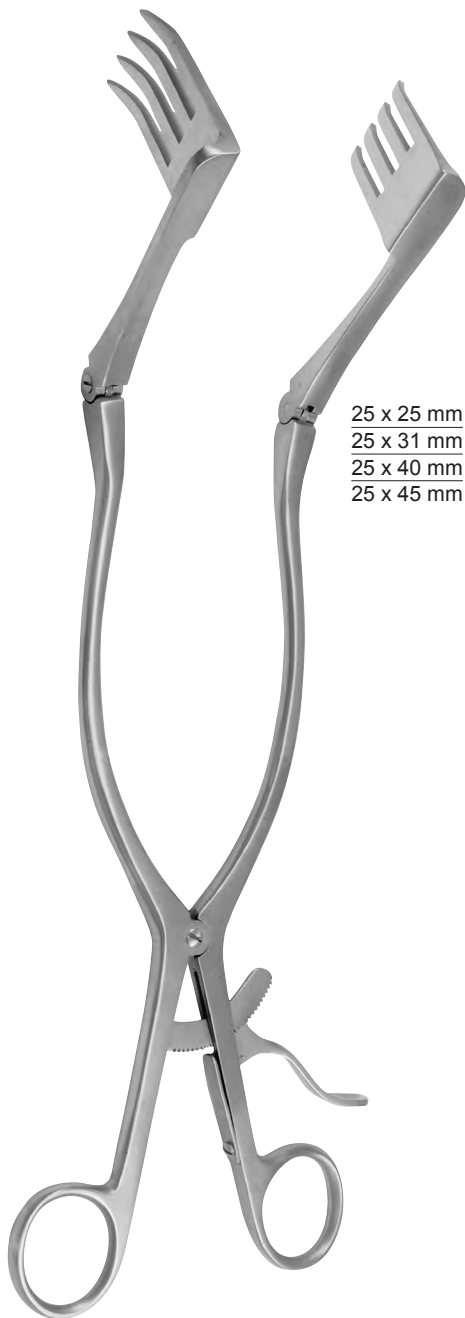

25 x 25 mm
 25 x 31 mm
 25 x 40 mm
 25 x 45 mm

070-870-01	070-871-01
070-870-02	070-871-02
070-870-03	070-871-03
070-870-04	070-871-04

scharf	stumpf
sharp	blunt
agudos	romo
acuti	smusso

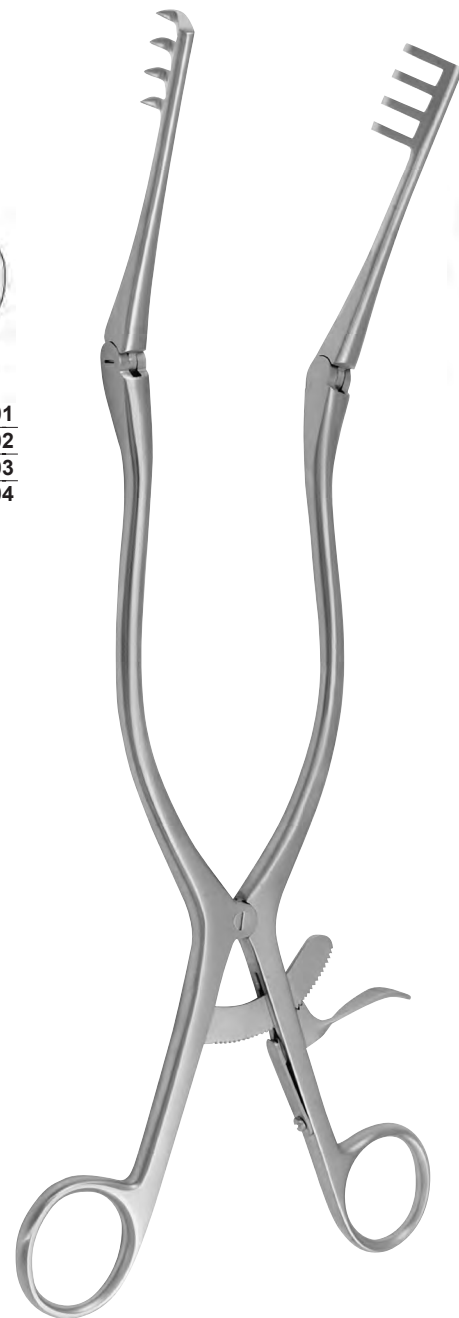

070-690-31
 scharf
 sharp
 agudos
 acuti

BECKMANN-ADSON
 31,0 cm, 12 1/4"

BECKMANN
 31,0 cm, 12 1/4"



BECKMANN
32,0 cm, 12½"



070-691-32
stumpf
blunt
romo
smusso



DE BAKEY
10,0 cm, 4" **070-240-10**
14,0 cm, 5½" **070-240-14**

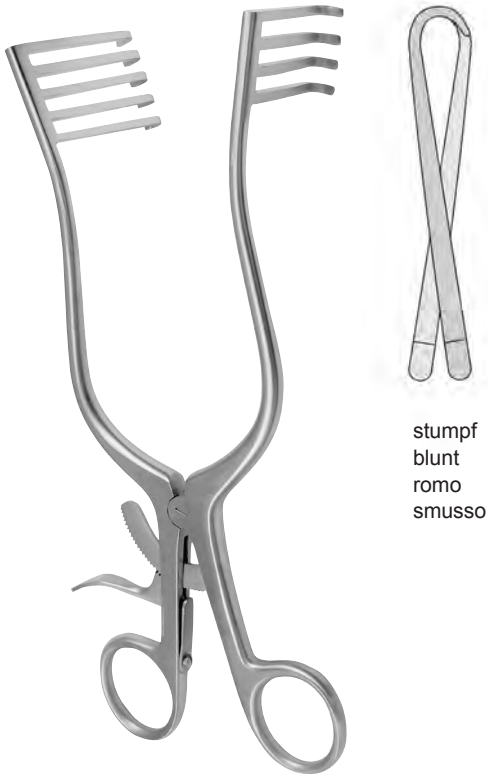

stumpf
blunt
romo
smusso

NORFOLK AND NORWICH
22,0 cm, 8⁵/₈"
070-401-22

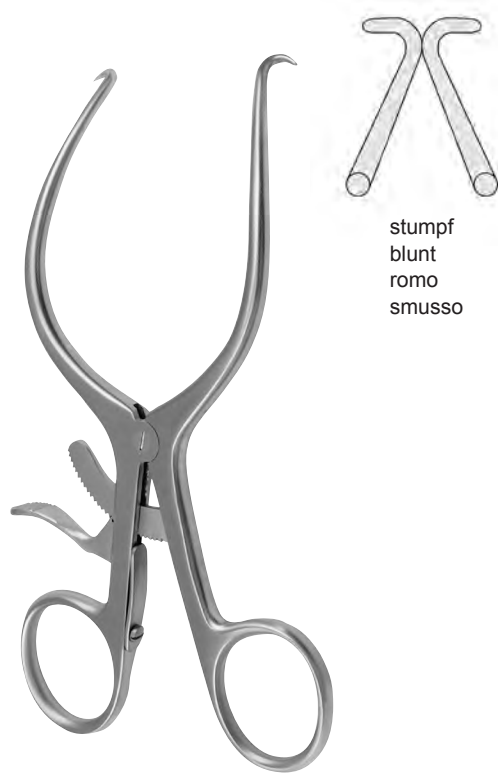

stumpf
blunt
romo
smusso

JACKSON BURROWS
17,5 cm, 7"
070-411-17



RICHTER
17,0 cm, 6³/₄"
070-420-17



JOLL (FRIEDMAN)
15,5 cm, 6"
070-430-15

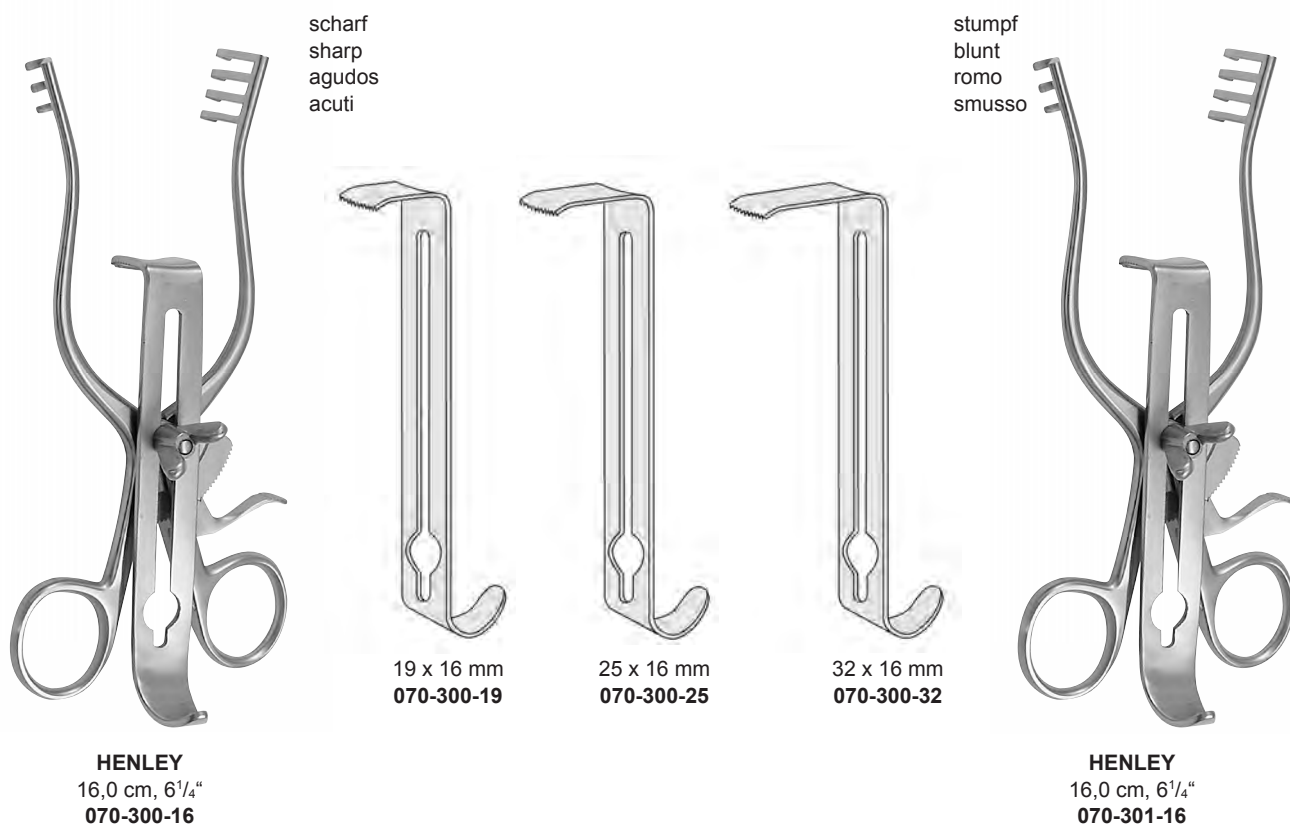

HENLEY
070-300-00

komplett, bestehend aus:

- 1 Sperrer mit Seitenvalven, scharf (30-1300-16)
- 1 Mittelvalve 19 x 16 mm (30-1300-19)
- 1 Mittelvalve 25 x 16 mm (30-1300-25)
- 1 Mittelvalve 32 x 16 mm (30-1300-32)

complete, consisting of:

- 1 Spreader with lateral valves, sharp (30-1300-16)
- 1 Central valve 19 x 16 mm (30-1300-19)
- 1 Central valve 25 x 16 mm (30-1300-25)
- 1 Central valve 32 x 16 mm (30-1300-32)

completo, compuesto of:

- 1 Separador con valvas laterales, agudas (30-1300-16)
- 1 Valva central 19 x 16 mm (30-1300-19)
- 1 Valva central 25 x 16 mm (30-1300-25)
- 1 Valva central 32 x 16 mm (30-1300-32)

completo, composto da:

- 1 Divaricatore con valve laterali, acuto (30-1300-16)
- 1 Valva centrale 19 x 16 mm (30-1300-19)
- 1 Valva centrale 25 x 16 mm (30-1300-25)
- 1 Valva centrale 32 x 16 mm (30-1300-32)

HENLEY
070-301-00

komplett, bestehend aus:

- 1 Sperrer mit Seitenvalven, stumpf (30-1301-16)
- 1 Mittelvalve 19 x 16 mm (30-1300-19)
- 1 Mittelvalve 25 x 16 mm (30-1300-25)
- 1 Mittelvalve 32 x 16 mm (30-1300-32)

complete, consisting of:

- 1 Spreader with lateral valves, blunt (30-1301-16)
- 1 Central valve 19 x 16 mm (30-1300-19)
- 1 Central valve 25 x 16 mm (30-1300-25)
- 1 Central valve 32 x 16 mm (30-1300-32)

completo, compuesto of:

- 1 Separador con valvas laterales, romas (30-1301-16)
- 1 Valva central 19 x 16 mm (30-1300-19)
- 1 Valva central 25 x 16 mm (30-1300-25)
- 1 Valva central 32 x 16 mm (30-1300-32)

completo, composto da:

- 1 Divaricatore con valve laterali, smusso (30-1301-16)
- 1 Valva centrale 19 x 16 mm (30-1300-19)
- 1 Valva centrale 25 x 16 mm (30-1300-25)
- 1 Valva centrale 32 x 16 mm (30-1300-32)

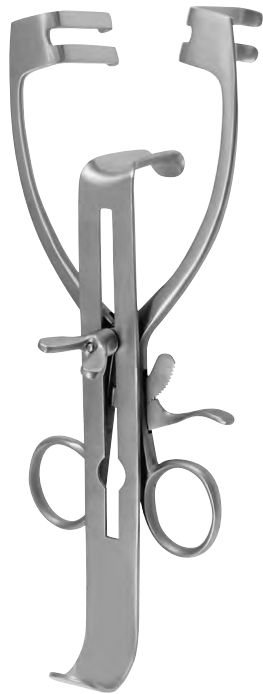

MAYO-ADAMS
17,0 cm, 6³/₄"
070-320-17



COLLIN-BABY
18,0 cm, 7"
070-330-18

30 x 44 mm
070-330-30

Wechselvalven
Exchangeable blades
Valvas intergambiables
Valve intercambiabili



23 x 44 mm
070-330-23

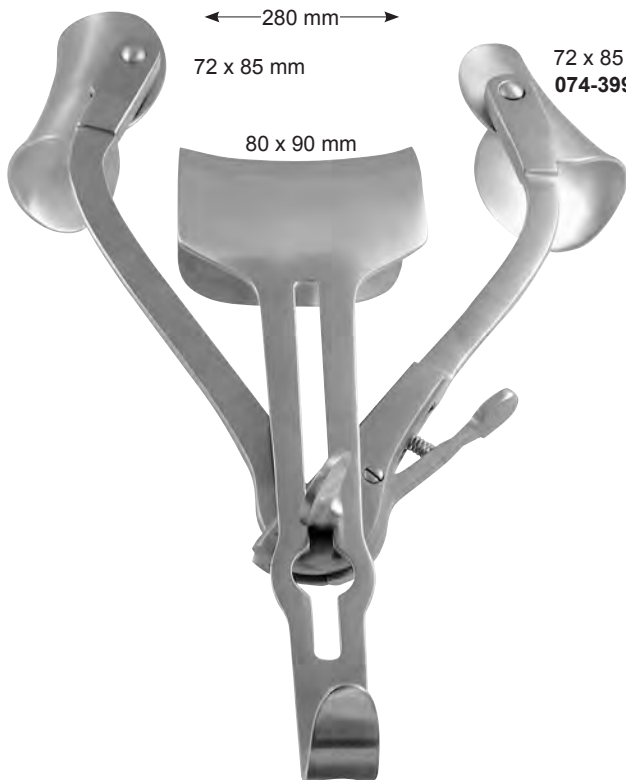

RICARD
28,0 cm, 11"
074-310-28



RICARD
30,0 cm, 12"
074-312-30

38 x 62 mm
074-398-10

← 135-160 mm →

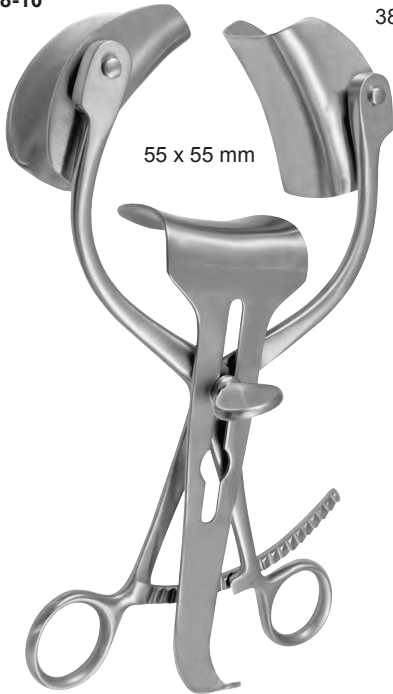

55 x 55 mm

38 x 62 mm

COLLIN
23,5 cm, 9 1/4"
074-330-24

← 135-160 mm →



55 x 65 mm

40 x 80 mm

40 x 80 mm
074-398-11

COLLIN
23,5 cm, 9 1/4"
074-332-24

60 x 80 mm
074-398-13

← 135-160 mm →



60 x 75 mm

60 x 80 mm

COLLIN
23,5 cm, 9 1/4"
074-334-24



38 x 62 mm	074-399-01
40 x 80 mm	074-399-02
60 x 80 mm	074-399-03



50 x 58 mm	074-399-10
60 x 80 mm	074-399-13
72 x 85 mm	074-399-14



074-399-23
60 x 80 mm



074-399-33
60 x 80 mm



58 x 50 mm	074-398-01
80 x 60 mm	074-398-02
85 x 72 mm	074-398-03



62 x 38 mm	074-398-10
80 x 38 mm	074-398-11
100 x 38 mm	074-398-12
80 x 38 mm	074-398-13



COLLIN

55 x 55 mm	074-331-01
55 x 65 mm	074-331-02
55 x 75 mm	074-331-03

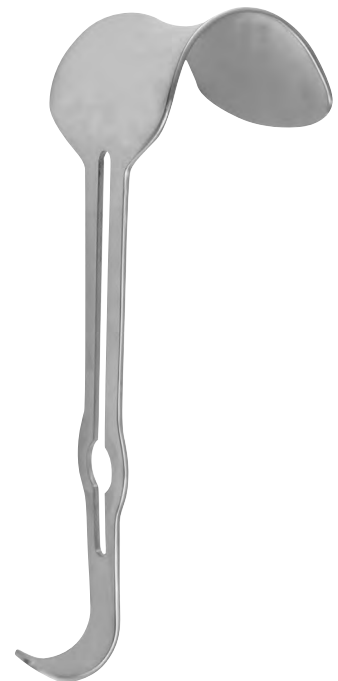

RICARD

65 x 50 mm	074-310-01
70 x 55 mm	074-310-02
90 x 80 mm	074-310-03

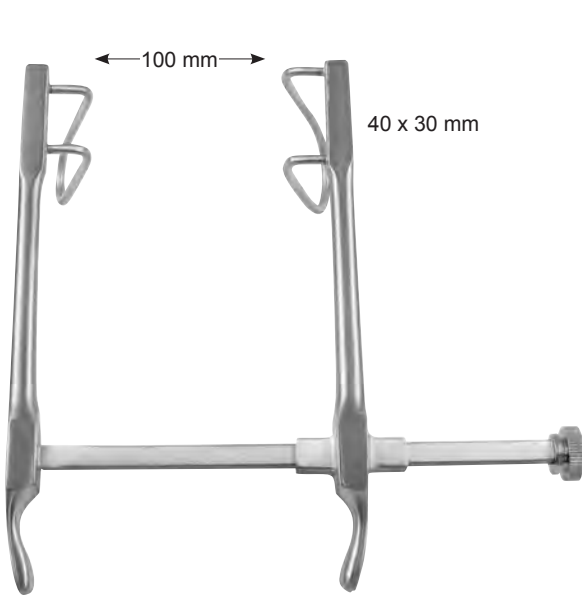

GOSSET
074-400-10

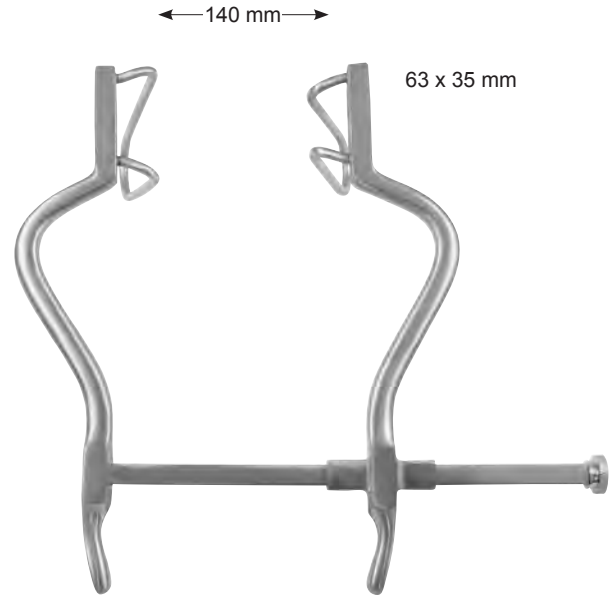

GOSSET
074-412-14

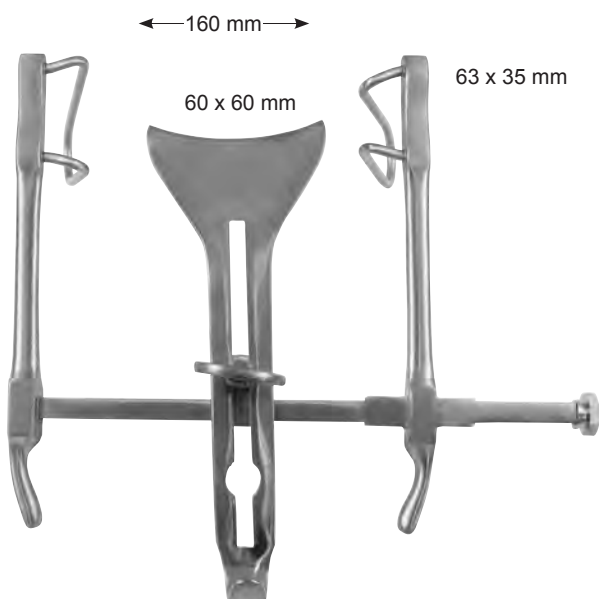

GOSSET
074-414-16

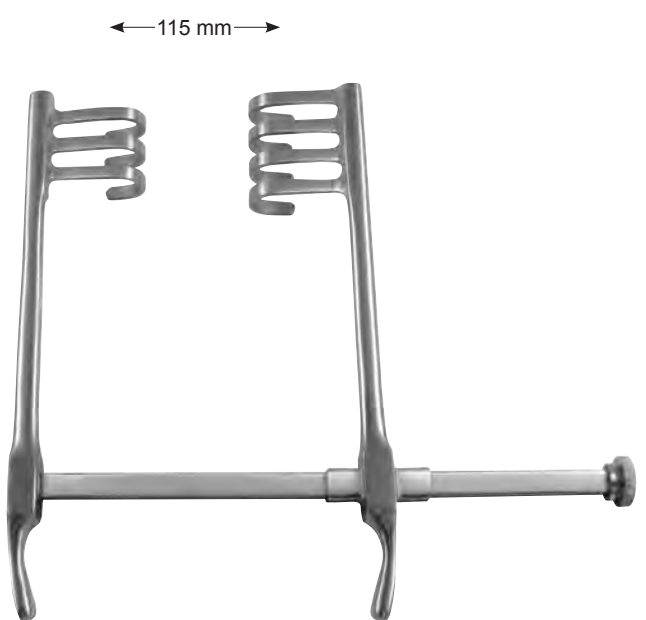

ABADIE
074-450-12

Abdominal Retractors

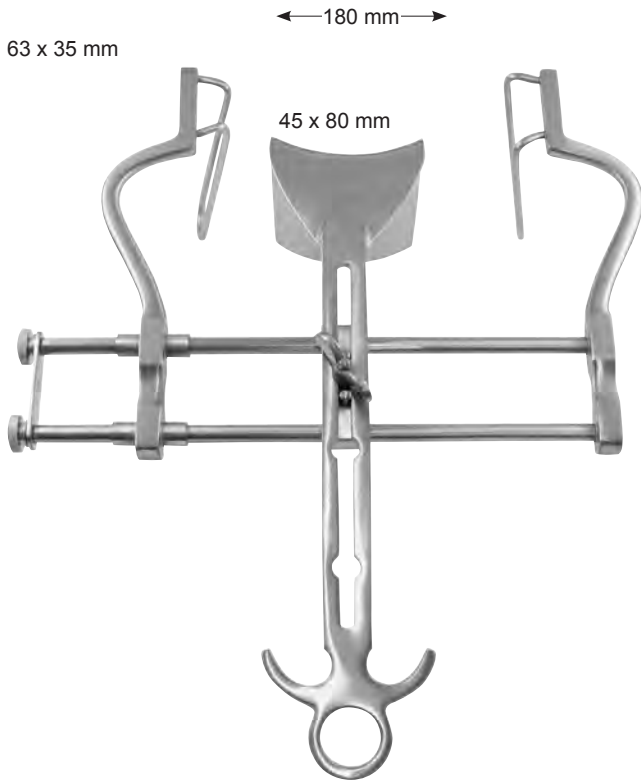

BALFOUR
074-764-18

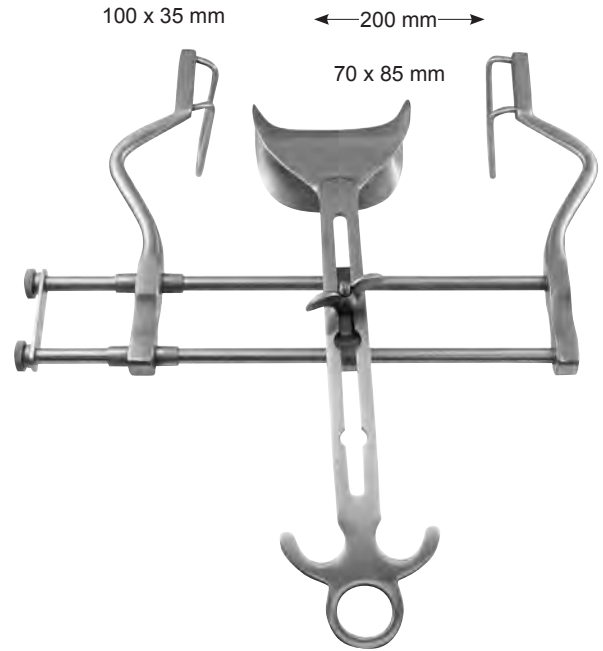

BALFOUR
074-768-20

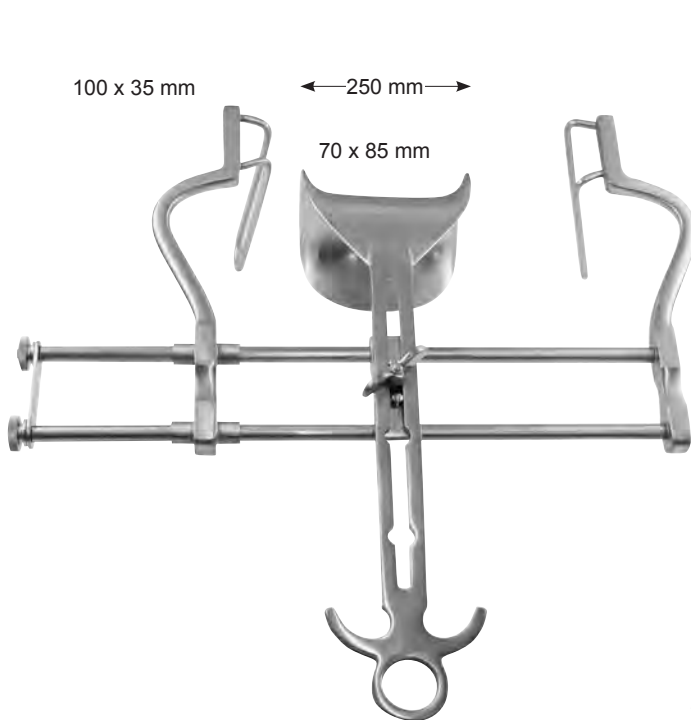

BALFOUR
074-768-25

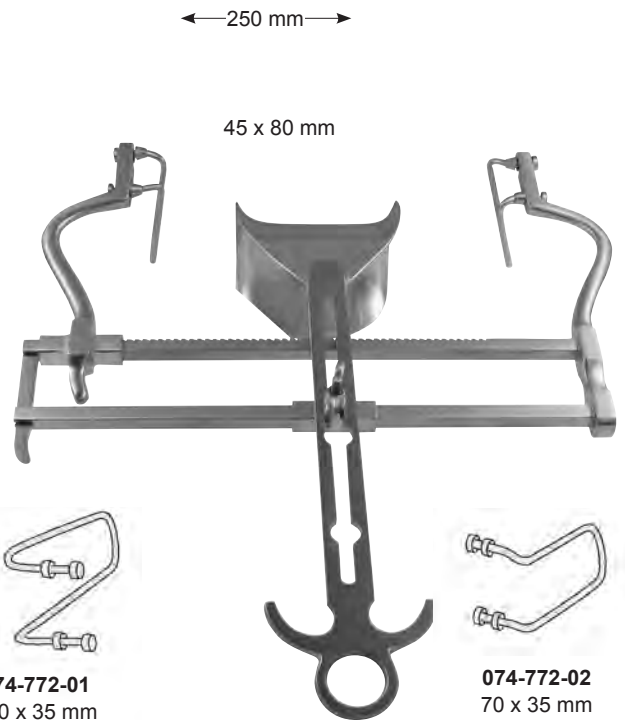

074-772-01
100 x 35 mm

074-772-02
70 x 35 mm

BALFOUR US-TYPE
074-772-25

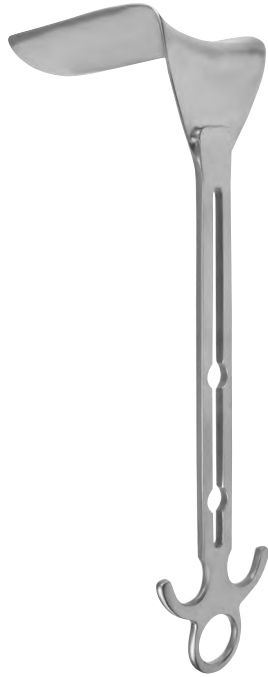

BALFOUR
100 x 70 mm
074-799-70

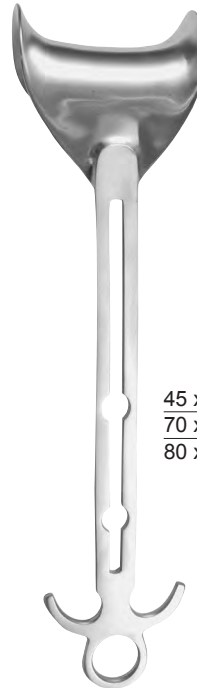

45 x 80 mm	074-798-01
70 x 85 mm	074-798-02
80 x 90 mm	074-798-03

BALFOUR

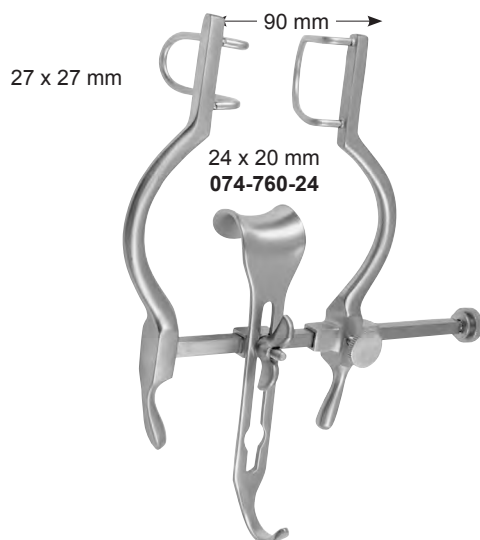

BALFOUR
074-760-09



Ø 180 mm, 7"	074-850-18
Ø 230 mm, 9"	074-850-23
Ø 305 mm, 12"	074-850-30
455 x 330 mm	074-850-45

geschwärzt, black finish, negra, nera;



074-859-02
51 x 38 mm



074-859-03
70 x 60 mm



074-859-05
114 x 60 mm

geschwärzt, black finish, negra, nera



074-859-06
19 x 76 mm



074-859-07
38 x 102 mm



074-859-08
57 x 89 mm



074-859-09
57 x 114 mm

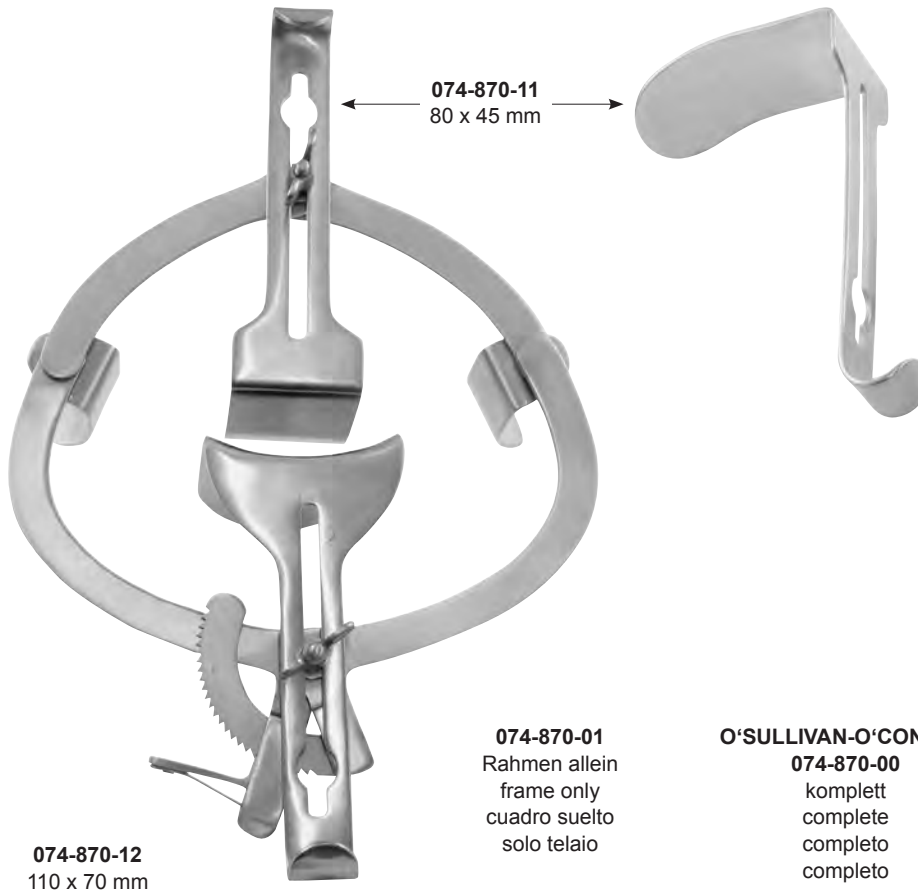
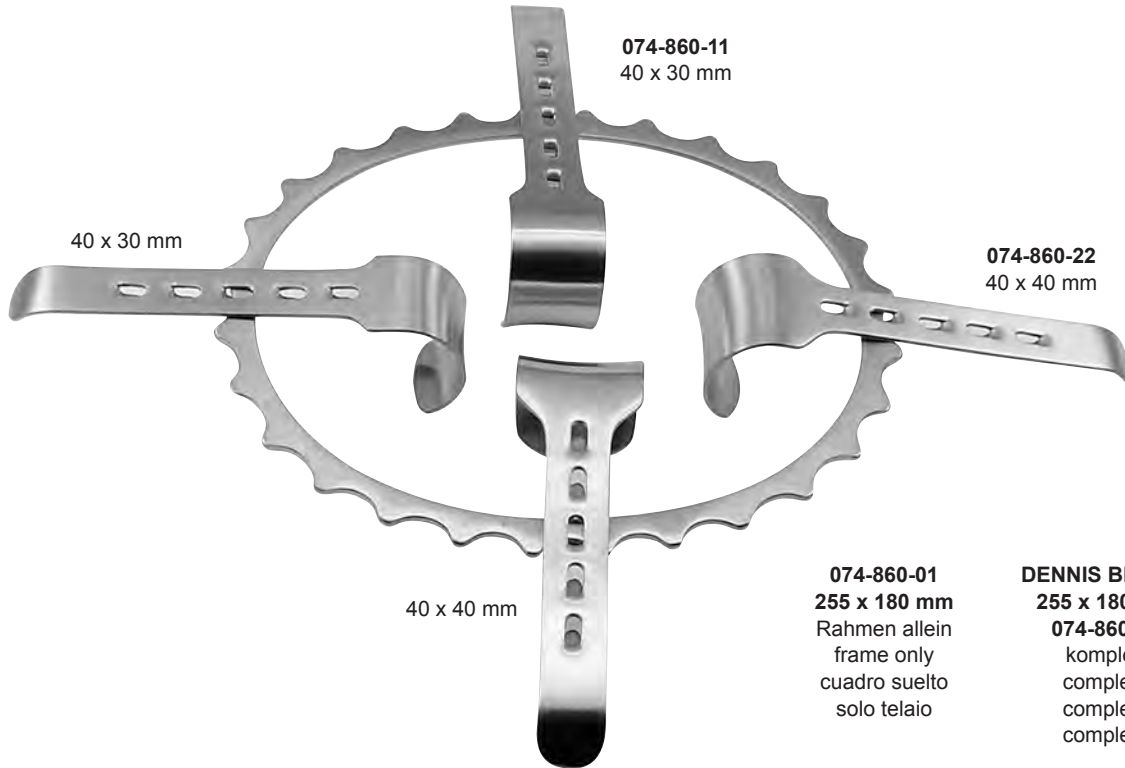

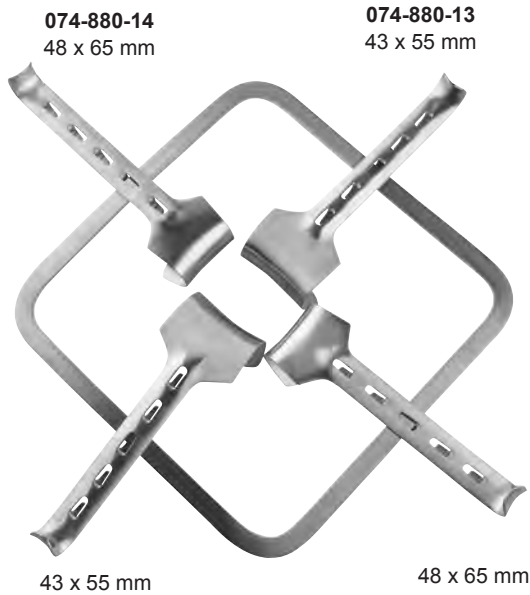

- | | | |
|-------------------|---------------|-------------------|
| 074-880-01 | 250 x 250 mm | KIRSCHNER |
| 074-880-02 | 300 x 320 mm | 074-880-00 |
| 074-880-03 | 300 x 380 mm | komplett |
| | Rahmen allein | complete |
| | frame only | completo |
| | cuadro suelto | completo |
| | solo telaio | 1 x 31-1880-01 |
| | | 2 x 31-1880-13 |
| | | 2 x 31-1880-14 |

074-882-01
255 x 255 mm
zusammenlegbarer Rahmen, allein
folding frame, only
cuadro piegable, suelto
telaio pieghevole, solo

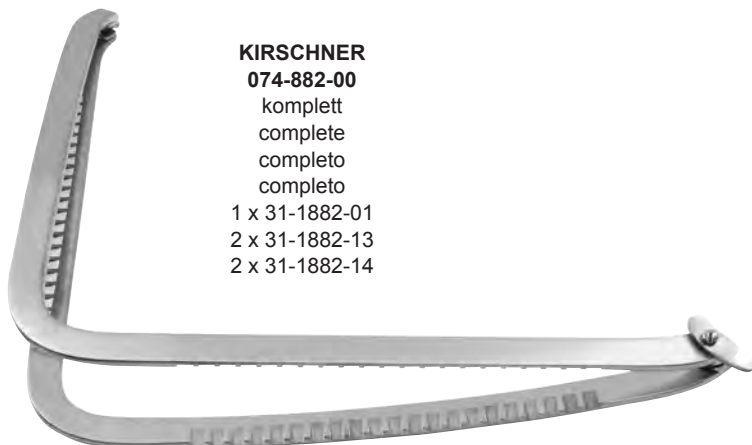

KIRSCHNER
074-882-00
komplett
complete
completo
completo
1 x 31-1882-01
2 x 31-1882-13
2 x 31-1882-14



- | | |
|------------|-------------------|
| 43 x 55 mm | 074-880-13 |
| 48 x 65 mm | 074-880-14 |
| 80 x 90 mm | 074-880-15 |
| 90 x 65 mm | 074-880-16 |
| 98 x 95 mm | 074-880-17 |

KIRSCHNER



KIRSCHNER
60 x 82 mm
074-880-11



KIRSCHNER-BALFOUR
83 x 82 mm
074-880-12



KIRSCHNER
98 x 51 mm **074-880-20**
105 x 38 mm **074-880-21**

074-880-14
48 x 65 mm

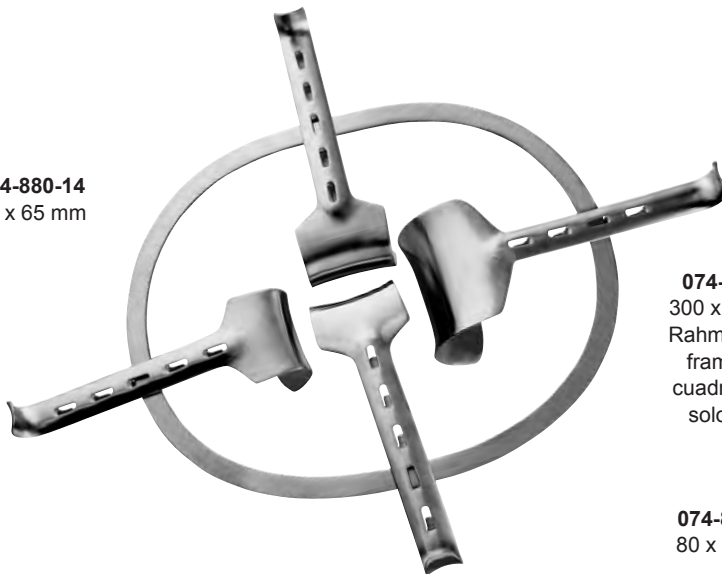

074-890-00
300 x 240 mm
Rahmen allein
frame only
cuadro suelto
solo telaio

074-880-15
80 x 90 mm

KIRSCHNER, oval
074-884-00

komplett, complete, completo, comple to
1 x 31-1884-01
3 x 31-1884-14
1 x 31-1884-15
1 x 31-1884-20
1 x 31-1884-21

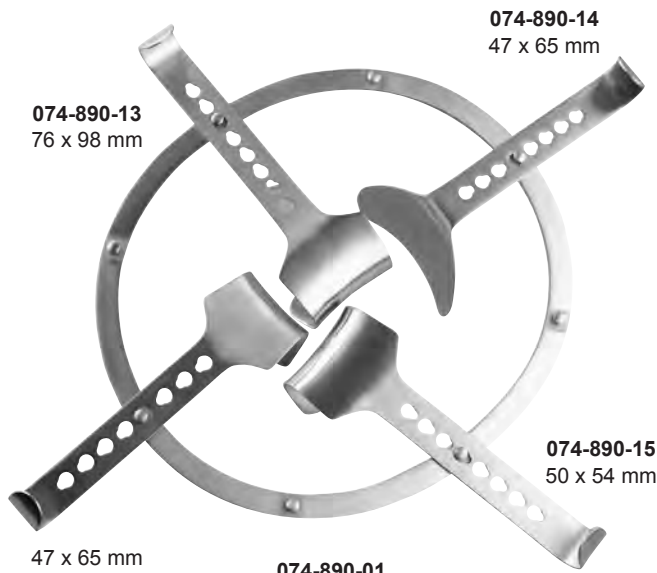

074-890-13
76 x 98 mm

074-890-14
47 x 65 mm

074-890-15
50 x 54 mm

47 x 65 mm

074-890-01
275 x 250 mm
Rahmen allein
frame only
cuadro suelto
solo telaio



074-890-11
98 x 52 mm

074-890-12
105 x 35 mm

074-900-01
300 x 300 mm
zusammenlegbarer Rahmen, allein
folding frame, only
cuadro plegable, suelto
telaio pieghevole, solo

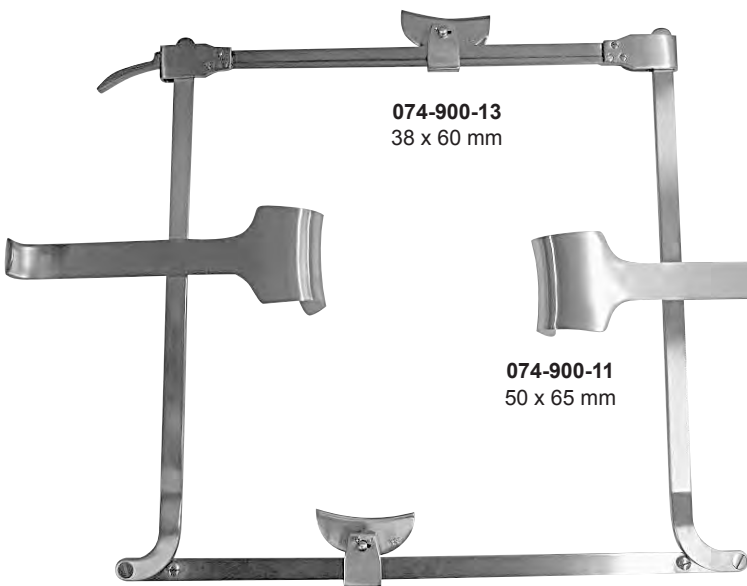

074-900-13
38 x 60 mm

074-900-11
50 x 65 mm



38 x 60 mm **074-900-13**
45 x 80 mm **074-900-14**

50 x 65 mm **074-900-11**
60 x 85 mm **074-900-12**

FRANZ
074-900-00
komplett
complete
completo
completo
1 x 31-1900-01
2 x 31-1900-11
2 x 31-1900-13

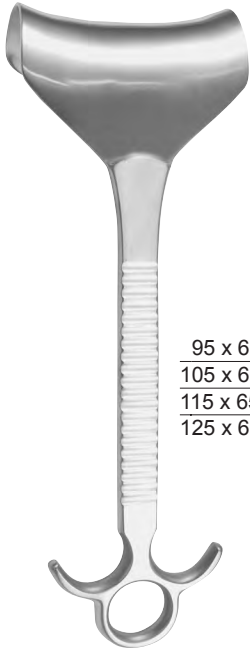

DOYEN
28,0 cm, 11"

95 x 60 mm	074-910-11
105 x 65 mm	074-910-12
115 x 65 mm	074-910-13
125 x 65 mm	074-910-14

für / for / para / per
074-910-11
074-910-14

Kette mit Gewicht
Chain with weight
Cadena con pesa
Catena con peso

53,0 cm, 21"

66,0 cm, 26"



074-915-30
78,5 cm, 31"

Befestigungsgestell
Mounting frame
Bastidor para la fijación
Telaio di supporto per il fissaggio

ROCHARD
074-920-01

53,0 cm, 21"

66,0 cm, 26"

Befestigungsgestell
Mounting frame
Bastidor para la fijación
Telaio di supporto per il fissaggio

ROCHARD
074-920-02



ROCHARD
28,0 cm, 11"
074-920-20

95 x 48 mm	074-920-10
105 x 48 mm	074-920-12
115 x 48 mm	074-920-12
125 x 48 mm	074-920-13
155 x 48 mm	074-920-16

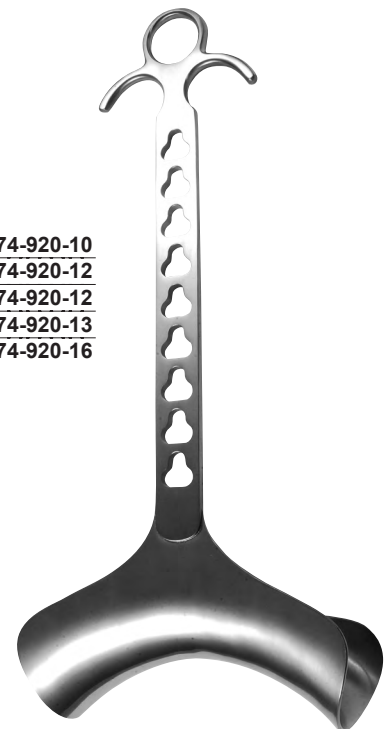

ROCHARD
28,0 cm, 11"

Abdominal Spatulas



biegsam
malleable
maleable
malleabile

- 200 x 6 mm **078-210-06**
- 200 x 12 mm **078-210-12**
- 200 x 17 mm **078-210-17**
- 200 x 20 mm **078-210-20**
- 200 x 25 mm **078-210-25**

RIBBON



biegsam
malleable
maleable
malleabile

- 330 x 13 mm **078-170-13**
- 330 x 25 mm **078-170-25**
- 330 x 32 mm **078-170-32**
- 330 x 40 mm **078-170-40**
- 330 x 50 mm **078-170-50**

RIBBON



biegsam
malleable
maleable
malleabile

- 280 x 25/30 mm **078-200-01**
- 300 x 37/45 mm **078-200-02**
- 300 x 40/50 mm **078-200-03**

RIBBON



biegsam
malleable
maleable
malleabile

TUFFIER
200 x 25/17 mm
078-220-20



REVERDIN
280 x 45/60 mm
078-230-28

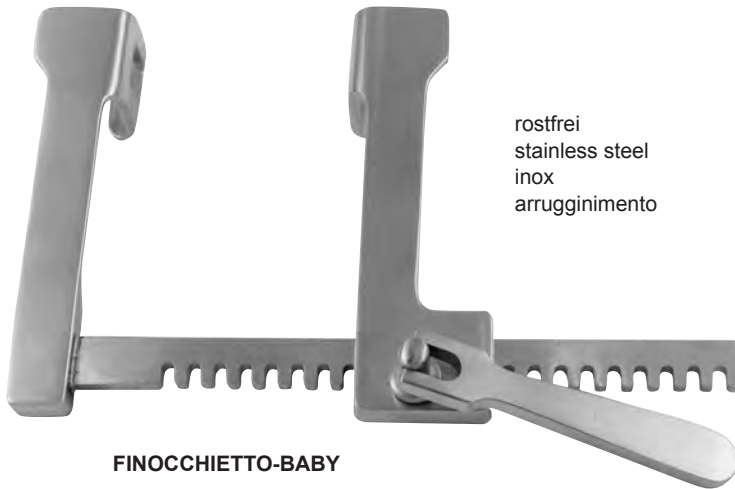

FINOCCHIETTO-BABY

a	b	c	
18 mm	20 mm	75 mm	140-100-01

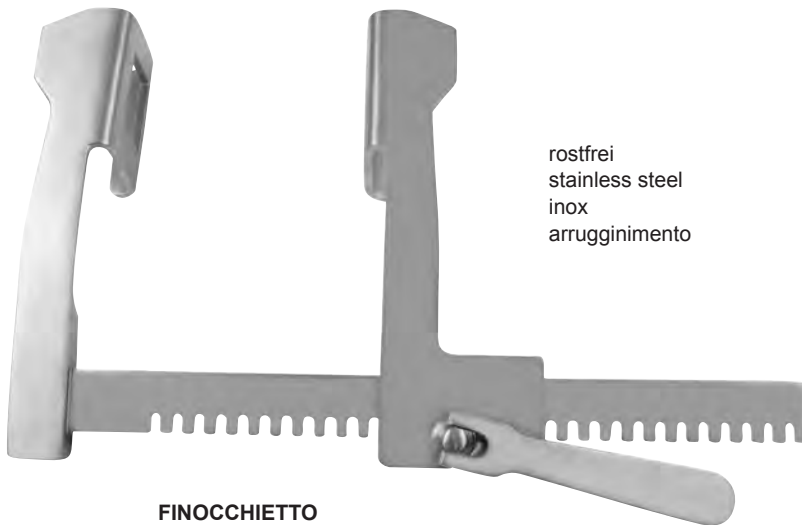

FINOCCHIETTO

a	b	c	
40 mm	40 mm	165 mm	140-100-02
45 mm	65 mm	200 mm	140-100-03
70 mm	65 mm	250 mm	140-100-04

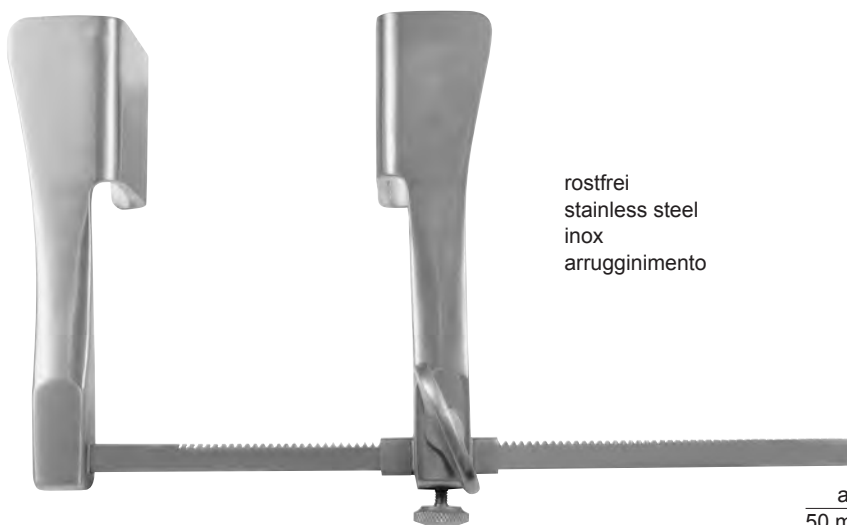

TUFFIER

a	b	c	
50 mm	45 mm	165 mm	140-150-01

Probes, Trocars



	Ø 1,0 mm	Ø 2,0 mm
11,5 cm, 4 1/2"	080-000-11	080-004-11
13,0 cm, 5"	080-000-13	080-004-13
14,5 cm, 5 3/4"	080-000-14	080-004-14
16,0 cm, 6 1/4"	080-000-16	080-004-15
18,0 cm, 7"	080-000-18	080-004-18
20,0 cm, 8"	080-000-20	080-004-20

Ø 2,0 mm



11,5 cm, 4 1/2"	080-013-11
13,0 cm, 5"	080-013-13
14,5 cm, 5 3/4"	080-013-14
16,0 cm, 6 1/4"	080-013-16
18,0 cm, 7"	080-013-18
20,0 cm, 8"	080-013-20

Ø 1,0 mm



Silber
Silver
Plata
Argento

STACKE
10,5 cm, 4 1/8"
080-033-10



Myrtenblattsonden
Myrtle leaf probes
Sondas para mirto
Sonde a foglia di mirto

11,5 cm, 4 1/2"	080-027-11
13,0 cm, 5"	080-027-13
14,5 cm, 5 3/4"	080-027-14
16,0 cm, 6 1/4"	080-027-16
18,0 cm, 7"	080-027-18
20,0 cm, 8"	080-027-20



NÉLATON
16,0 cm, 6 1/4"
080-120-16



DOYEN
14,5 cm, 5 3/4"
080-117-14

Ø 3,5 mm



BRODIE
20,0 cm, 8"
080-126-20

Ø 3,5 mm



- 11,5 cm, 4 1/2" **080-110-11**
- 13,0 cm, 5" **080-110-13**
- 14,5 cm, 5 3/4" **080-110-14**
- 16,0 cm, 6 1/4" **080-110-16**
- 18,0 cm, 7" **080-110-18**
- 20,0 cm, 8" **080-110-20**

Ø 3,3 mm



- 13,0 cm, 5" **080-122-13**
- 14,5 cm, 5 3/4" **080-122-14**
- 16,0 cm, 6 1/4" **080-122-16**
- 18,0 cm, 7" **080-122-18**



LOCKHART-MUMMERY
16,5 cm, 6 1/2"
080-130-01



LOCKHART-MUMMERY
16,5 cm, 6 1/2"
080-130-02



LOCKHART-MUMMERY
16,5 cm, 6 1/2"
080-130-03

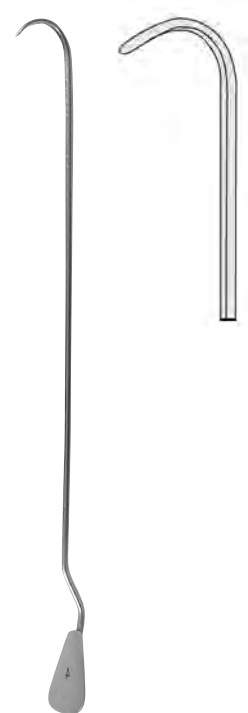

LOCKHART-MUMMERY
16,5 cm, 6 1/2"
080-130-04

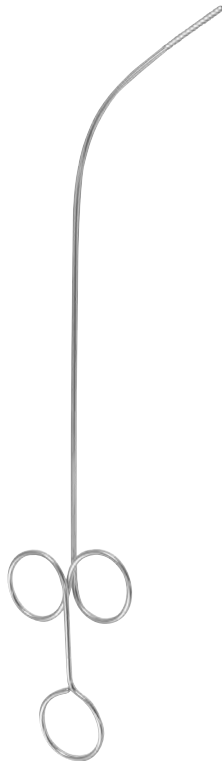

FEIN
28,0 cm, 11"
080-264-28



UKERMANN
16,0 cm, 6 1/4"
080-260-16

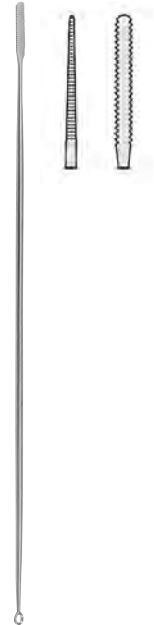

JOBSON-HORNE
18,0 cm, 7"
080-262-18



12,0 cm, 4 3/4" **080-271-12** Ø 0,9 mm
14,0 cm, 5 3/4" **080-271-14** Ø 0,9 mm
16,5 cm, 6 1/4" **080-271-16** Ø 1,1 mm
18,0 cm, 7" **080-271-18** Ø 1,2 mm

FARRELL
(LATHBURY)



12,0 cm, 4 3/4" **080-270-12** Ø 0,9 mm
14,0 cm, 5 3/4" **080-270-14** Ø 0,9 mm
16,5 cm, 6 1/4" **080-270-16** Ø 1,1 mm
18,0 cm, 7" **080-270-18** Ø 1,2 mm

FARRELL



080-150-01
 Metalletui
 Metal case
 Estuche de metal
 Scatola in metallo
 135 x 100 x 25 mm



Ø 3,0 mm
080-150-03



Ø 6,0 mm
080-150-06



Ø 9,0 mm
080-150-09



Ø 12,0 mm
080-150-12

NABATOFF
080-150-00
 komplett
 complete
 completo
 completo



080-150-21
 Zugseil
 Cable
 Cable
 Fune

080-150-22
 Kunststoff-Sondenspitze
 Plastic probe tip
 Extremidad de sonda de plástico
 Punta in materia plastica

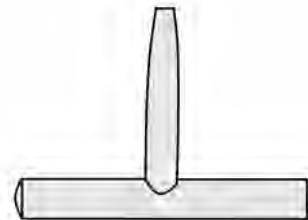

080-150-20
 Handgriff
 Handle
 Mango
 Manico



Ø 3,0 mm	084-110-30
Ø 3,5 mm	084-110-35
Ø 4,0 mm	084-110-40
Ø 4,5 mm	084-110-45
Ø 5,0 mm	084-110-50
Ø 5,5 mm	084-110-55
Ø 6,0 mm	084-110-60

STANDARD
11,0 cm, 4³/₈"



Ø 3,0 mm	084-112-30
Ø 3,5 mm	084-112-35
Ø 4,0 mm	084-112-40
Ø 4,5 mm	084-112-45
Ø 5,0 mm	084-112-50
Ø 5,5 mm	084-112-55
Ø 6,0 mm	084-112-60

STANDARD
12,0 cm, 4³/₄"



Ø 3,0 mm	084-114-30
Ø 3,5 mm	084-114-35
Ø 4,0 mm	084-114-40
Ø 4,5 mm	084-114-45
Ø 5,0 mm	084-114-50
Ø 5,5 mm	084-114-55
Ø 6,0 mm	084-114-60

STANDARD
12,0 cm, 4³/₄"



Ø 7,3 mm	084-118-07
Ø 8,7 mm	084-118-09
Ø 12,0 mm	084-118-12

HURWITZ



UNIVERSAL
084-100-03

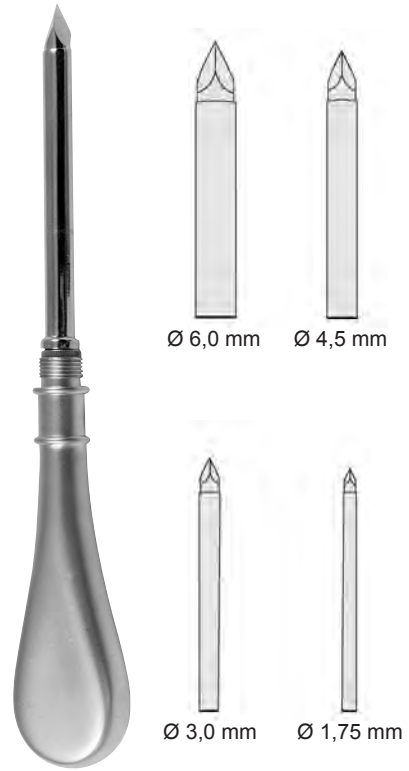

UNIVERSAL
084-100-04

140 mm

LANDAU
Ø 2,0 mm
084-160-16

LANDAU
Ø 2,0 mm
084-161-16

DAVIDSON
Ø 6,0 mm
084-164-18

BUELAU
Ø 8,0 mm
084-124-24

Trocars



Ø 6,0 mm **084-128-06**
 Ø 8,0 mm **084-128-08**

CAMPBELL
 16,0 cm, 6 1/4"



80 mm

Ø 7,5 mm **084-120-01**
 Ø 9,0 mm **084-120-02**
 Ø 10,5 mm **084-120-03**
 Ø 12,0 mm **084-120-04**

NELSON
 21,0 cm, 8 1/2"

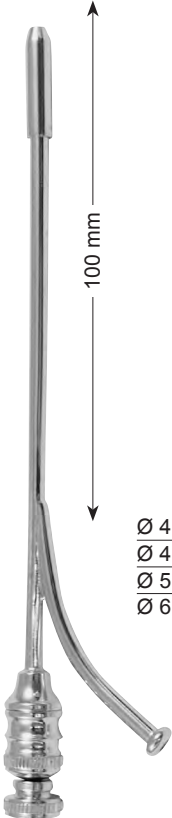

100 mm

Ø 4,0 mm **084-140-01**
 Ø 4,6 mm **084-140-02**
 Ø 5,5 mm **084-140-03**
 Ø 6,5 mm **084-140-04**

OCHSNER
 14,0 cm, 5 1/2"

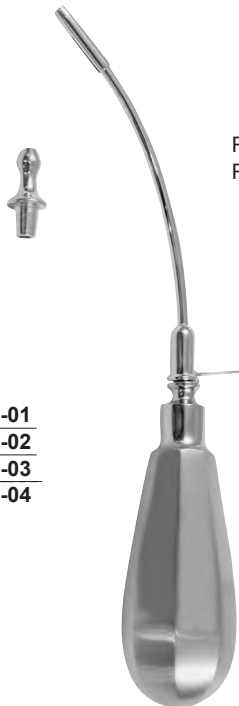

Record Konus
 Record cone

Ø 3,0 mm **084-180-30**
 Ø 4,0 mm **084-180-40**
 Ø 5,0 mm **084-180-50**

PIERCE
 16,0 cm, 6 1/4"



Ø 2,25 mm

COAKLEY
 14,0 cm, 5 1/4"
084-190-14

Ø 4,0 mm



KRAUSE
16,0 cm, 6 1/4"

LICHTWITZ
Kieferhöhlentrokare
Antrum trocars
Trócares para el seno maxilar
Trequarti per puntura del seno mascellare

Ø 3,0 mm **084-184-30**
Ø 4,0 mm **084-184-40**
Ø 5,0 mm **084-184-50**
Ø 5,5 mm **084-184-55**

Ø 1,8 mm



LICHTWITZ
20,0 cm, 8"
084-170-00



LICHTWITZ
11,0 cm, 4 1/2"
084-172-00



DOUGLAS
Ø 3,0 mm
084-175-00



POOLE
22,0 cm, 8 5/8"
Ø 6,0 mm **085-020-06**
Ø 10,0 mm **085-020-10**



POOLE
22,0 cm, 8 5/8"
Ø 6,0 mm **085-021-06**
Ø 8,0 mm **085-021-08**

Suction Tubes

auswechselbare Spitze
interchangeable tip
punta intercambiabile
tipo intercambiabile



Ø 3,5 mm
085-010-35



085-024-00
Olive allein
Olive only
Oliva suelto
Olivo solo



COUPLAND
17,0 cm, 6³/₄"
085-010-17



YANKAUER
27,0 cm, 10⁵/₈"
085-000-27



DE BAKEY
27,0 cm, 10⁵/₈"
085-008-27



ANTHONY
26,0 cm, 10¹/₄"
085-007-26



ANDREWS-PYNCHON
24,0 cm, 9¹/₂"
085-006-24



COOLEY
35,0 cm, 13³/₄"
Ø 8,0 mm
085-024-02



COOLEY
30,0 cm, 11³/₄"
Ø 7,0 mm
085-024-03



COOLEY
31,0 cm, 11³/₄"
Ø 10,0 mm
085-024-04



COOLEY
33,0 cm, 13"
Ø 8,0 mm
085-024-01



BYRD
 20,0 cm, 8"
 Ø 1,5 mm **085-012-15**
 Ø 2,5 mm **085-012-25**
 Ø 3,5 mm **085-012-35**

Ø 4,0 mm



ADSON
 21,0 cm, 8 1/4"
085-050-21



MAGILL
 17,5 cm, 6 5/8"
 Ø 1,0 mm **085-060-01**
 Ø 2,0 mm **085-060-02**
 Ø 3,0 mm **085-060-03**
 Ø 4,0 mm **085-060-04**



FRAZIER
 19,0 cm, 7 1/2"

Charr. 6 **085-030-06**
 Charr. 8 **085-030-08**
 Charr. 10 **085-030-10**
 Charr. 12 **085-030-12**



FERGUSON
 18,0 cm, 7"

Charr. 6 **085-033-06**
 Charr. 8 **085-033-08**
 Charr. 10 **085-033-10**
 Charr. 12 **085-033-12**

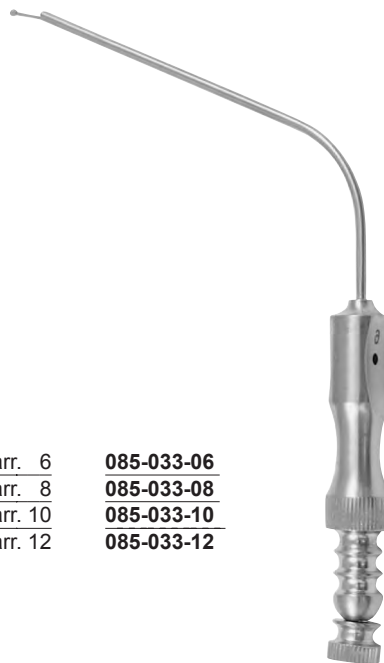

POPPEN
 13,0 cm, 5"

Charr. 6 **085-034-06**
 Charr. 8 **085-034-08**
 Charr. 10 **085-034-10**
 Charr. 12 **085-034-12**

Special Needles



Packung zu 12 Stück
 Package of 12 pcs.
 Cajecita de 12 pzs.
 Confezione da 12 pezzi

- Ø 0,90 x 38 mm **086-000-01**
- Ø 0,80 x 32 mm **086-000-02**
- Ø 0,70 x 32 mm **086-000-03**
- Ø 0,65 x 28 mm **086-000-04**
- Ø 0,60 x 25 mm **086-000-05**
- Ø 0,50 x 23 mm **086-000-06**
- Ø 0,45 x 20 mm **086-000-07**

LUER-LOCK

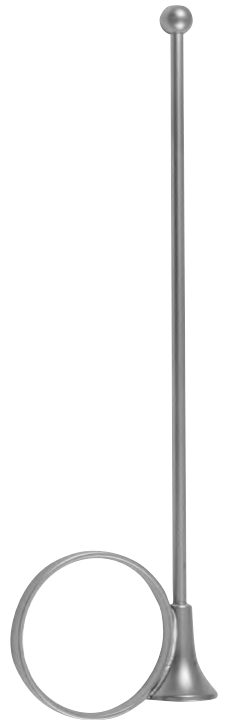

IOWA
 14,0 cm, 5 1/4"
086-150-14

Ø 1,0 x 185 mm

086-150-01
 Nadel
 Needle
 Aguja
 Aghi



MOCK
 6,0 cm, 2 3/8"
086-200-06



SCHMID
 15,0 cm, 6"



Ø 3,0 mm
086-140-03



Ø 4,0 mm
086-140-04



Ø 5,0 mm
086-140-05



Ø 6,0 mm
086-140-06

Gefäßspülkanülen, biegsam
 Vascular irrigation cannulae, malleable
 Cánulas vasculares para irrigación, maleables
 Aghi vascolari per irrigazione, malleabili



\varnothing 1,20 x 80 mm **086-210-12**
 \varnothing 1,50 x 80 mm **086-210-15**



\varnothing 2,00 x 100 mm **086-180-10**
 \varnothing 2,00 x 120 mm **086-180-12**
 \varnothing 2,00 x 150 mm **086-180-15**

VERESS

Kanülen zur Sternalpunktion
 Sternum puncture needles
 Aguja para la punción del esternón
 Aghi per puntura dello sterno



KLIMA-ROSSEGER
 \varnothing 1,60 x 40 mm
086-060-16

Kanülen zur Lumbalpunktion
 Lumbar puncture needles
 Aguja para punción lumbar
 Aghi per punture lombari



\varnothing 0,8 x 70/80/90/100/120 mm **086-130-01**
 \varnothing 1,0 x 70/80/90/100/120 mm **086-130-02**
 \varnothing 1,2 x 70/80/90/100/120 mm **086-130-03**
 \varnothing 1,4 x 70/80/90/100/120 mm **086-130-04**
 \varnothing 1,6 x 70/80/90/100/120 mm **086-130-05**
 \varnothing 1,8 x 70/80/90/100/120 mm **086-130-06**
 \varnothing 2,0 x 70/80/90/100/120 mm **086-130-07**

BIER

Kanülen zur Lumbalpunktion
Lumbar puncture needles
Agujas para punción lumbar
Aghi per punture lombari



QUINKE

Ø 1,20 x 76 mm	086-120-01
Ø 1,20 x 89 mm	086-120-02
Ø 1,00 x 76 mm	086-120-03
Ø 1,00 x 89 mm	086-120-04
Ø 0,70 x 76 mm	086-120-05
Ø 0,70 x 50 mm	086-120-06
Ø 0,70 x 89 mm	086-120-07

Kanülen zur Lumbalpunktion
Lumbar puncture needles
Agujas para punción lumbar
Aghi per punture lombari

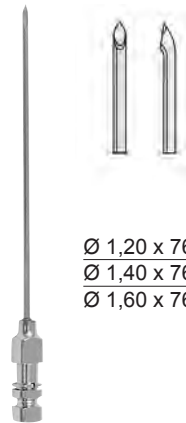

TUHOJ

Ø 1,20 x 76 mm	086-090-12
Ø 1,40 x 76 mm	086-090-14
Ø 1,60 x 76 mm	086-090-16

Kanülen zur Leberblindpunktion
Liver blind puncture needles
Agujas para punción ciega del hígado
Aghi per punture cieca del fegato



MENGHINI

Ø 1,00 x 35 mm	086-115-01
Ø 1,00 x 70 mm	086-115-02
Ø 1,20 x 70 mm	086-115-03
Ø 1,20 x 100 mm	086-115-04
Ø 1,40 x 70 mm	086-115-05
Ø 1,40 x 100 mm	086-115-06
Ø 1,60 x 70 mm	086-115-07
Ø 1,60 x 100 mm	086-115-08

Kanülen zur gezielten Leberpunktion
Needles for controlled liver puncture
Agujas para la punción del hígado bajo el control laparoscópico
Aghi per la punture controllata del fegato



MENGHINI

Ø 1,40 x 168 mm	086-117-14
Ø 1,80 x 168 mm	086-117-18

Trokare für Kanülen
Trocars for needles
Trocares para agujas
Trequarti oer aghi



Ø 1,40 x 168 mm	086-230-14
Ø 1,80 x 168 mm	086-230-18



- 1 ml **087-051-01**
- 2 ml **087-051-02**
- 5 ml **087-051-05**
- 10 ml **087-051-10**
- 20 ml **087-051-20**
- 50 ml **087-051-50**



- 1 ml **087-001-01**
- 2 ml **087-001-02**
- 5 ml **087-001-05**
- 10 ml **087-001-10**
- 20 ml **087-001-20**
- 50 ml **087-001-50**



- 1 ml **087-061-01**
- 2 ml **087-061-02**



LUER

- 1 ml **087-050-01**
- 2 ml **087-050-02**
- 5 ml **087-050-05**
- 10 ml **087-050-10**
- 20 ml **087-050-20**
- 50 ml **087-050-50**



LUER-LOCK

- 1 ml **087-000-01**
- 2 ml **087-000-02**
- 5 ml **087-000-05**
- 10 ml **087-000-10**
- 20 ml **087-000-20**
- 50 ml **087-000-50**



LUER-LOCK

- 2 ml **087-055-02**
- 5 ml **087-055-05**
- 10 ml **087-055-10**

INSULIN LUER



- 1 ml **087-060-01**
- 2 ml **087-060-02**



50 ml **087-071-05**
 100 ml **087-071-10**
 150 ml **087-071-15**
 200 ml **087-071-20**



10 ml **087-081-10**
 20 ml **087-081-20**
 30 ml **087-081-30**
 50 ml **087-081-50**



JANET

50 ml **087-070-05**
 100 ml **087-070-10**
 150 ml **087-070-15**
 200 ml **087-070-20**

Zwischenstück, LUER-LOCK weiblich
Connecting piece, LUER-LOCK female
Pieza de conexión, LUER-LOCK hembra
Raccordo, LUER-LOCK femmina



087-911-00

Zwischenstück, LUER-LOCK männlich
Connecting piece, LUER-LOCK male
Pieza de conexión, LUER-LOCK masculino
Raccordo, LUER-LOCK maschio



087-930-02

Zwischenstück, LUER-LOCK männlich
Connecting piece, LUER-LOCK male
Pieza de conexión, LUER-LOCK masculino
Raccordo, LUER-LOCK maschio

Ø 6 mm Ø 8 mm



087-912-06 087-912-08

Zwischenstück, LUER-LOCK weiblich
Connecting piece, LUER-LOCK female
Pieza de conexión, LUER-LOCK hembra
Raccordo, LUER-LOCK femmina



087-913-00

Zwischenstück, LUER-LOCK männlich
Connecting piece, LUER-LOCK male
Pieza de conexión, LUER-LOCK masculino
Raccordo, LUER-LOCK maschio



087-935-00

Durchflußhahn, LL männl. – LL weibl.
Stopcock, LL male – LL female
Llave, LL masculino – LL hembra
Rubinetto, LL maschio – LL femmina



087-939-00

Durchflußhahn, LL weiblich
Stopcock, LL female
Llave, LL hembra
Rubinetto, LL femmina



087-920-00

Dreiweghahn, 1 LL männl. – 2 LL weibl.
Three-way-stopcock, 1 LL male – 2 LL female
Llave de 3 vías, 1 LL masculino – 2 LL hembra
Rubinetto a tre vie, 1 LL maschio – 2 LL femmina



087-922-00

Dreiweghahn, 3 LL weiblich
Three-way-stopcock, 3 LL female
Llave de 3 vías, 3 LL hembra
Rubinetto a tre vie, 3 LL femmina



087-926-00

Gall, Liver, Kidney, Bladder, Urology



RANDALL



23,0 cm, 9"
158-001-01

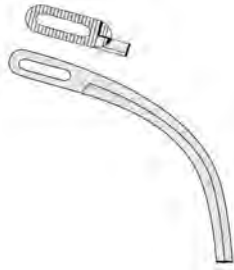

22,0 cm, 8⁵/₈"
158-001-02

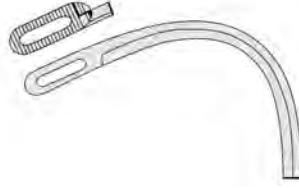

22,0 cm, 8⁵/₈"
158-001-03



22,0 cm, 8⁵/₈"
158-001-04

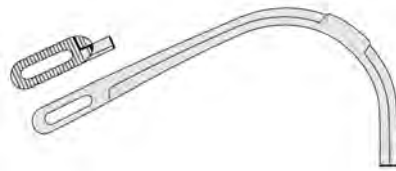

19,0 cm, 7¹/₂"
158-001-05

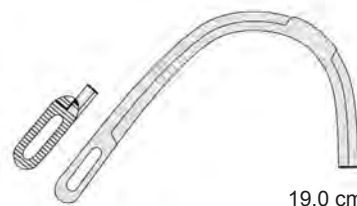

19,0 cm, 7¹/₂"
158-001-06

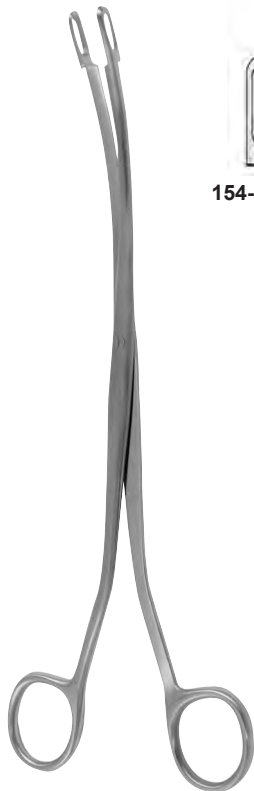

DESJARDINS
23,0 cm, 9"



154-001-01



154-001-02



MIXTER
22,0 cm, 8⁵/₈"
154-021-22

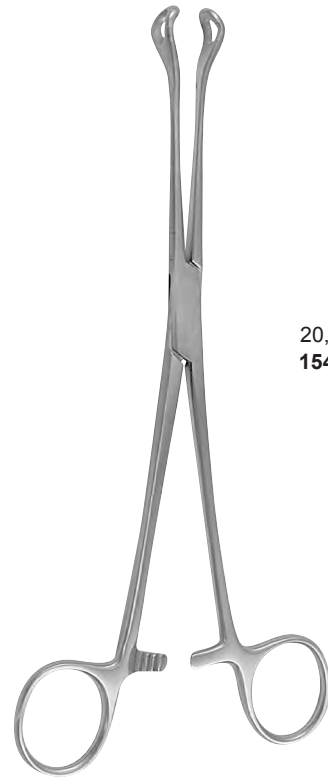

MAYO BLAKE
20,0 cm, 8"
154-008-20

20,0 cm, 8"
154-009-20



BLAKE
20,0 cm, 8"
154-006-20

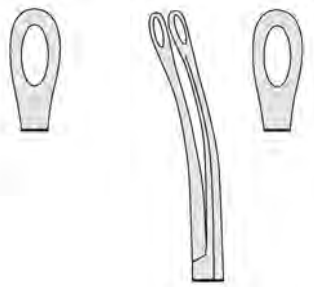

20,0 cm, 8"
154-005-20



TURNER-WARWICK
18,0 cm, 7"



154-031-01

154-031-03



CZERNY
24,5 cm, 9⁵/₈"
154-039-24





LUER-KÖRTE
24,0 cm, 9 1/2"



Fig. 000
2,8 mm
154-080-01



Fig. 00
3,4 mm
154-080-02



Fig. 2
6,7 mm
154-080-05



Fig. 3
8,0 mm
154-080-06

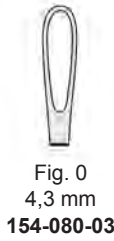

Fig. 0
4,3 mm
154-080-03



Fig. 1
5,5 mm
154-080-04



Fig. 4
11,0 mm
154-080-07

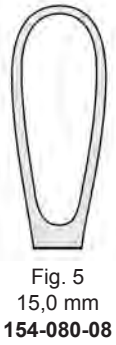

Fig. 5
15,0 mm
154-080-08



FERGUSSON
21,5 cm, 8 1/2"
154-070-01



MAYO
27,0 cm, 10 5/8"
154-072-01



MAYO
27,0 cm, 10 5/8"



154-074-01

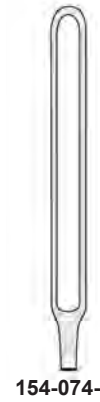

154-074-02



MOYNIHAN
34,0 cm, 13 3/8"
154-076-34



MAYO
32,0 cm, 12¹/₂"
154-078-32



OCHSNER
35,0 cm, 13³/₄"
154-082-35



DESJARDINS
28,0 cm, 11"



MOORE
30,0 cm, 12"
154-084-30

Gallenblasenlöffel
Gall bladder scoope
Cuccharilla para la vesicula biliar
Cucchiaio per colecisti



DESJARDINS
28,0 cm, 11"

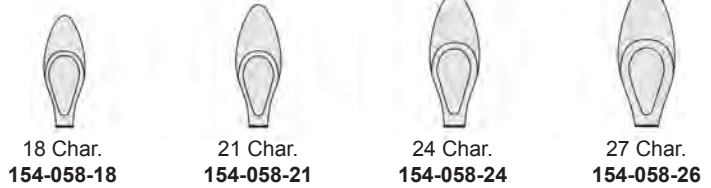

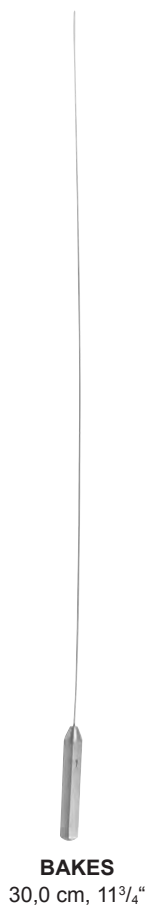
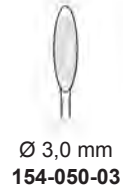
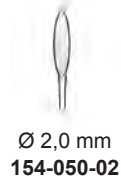

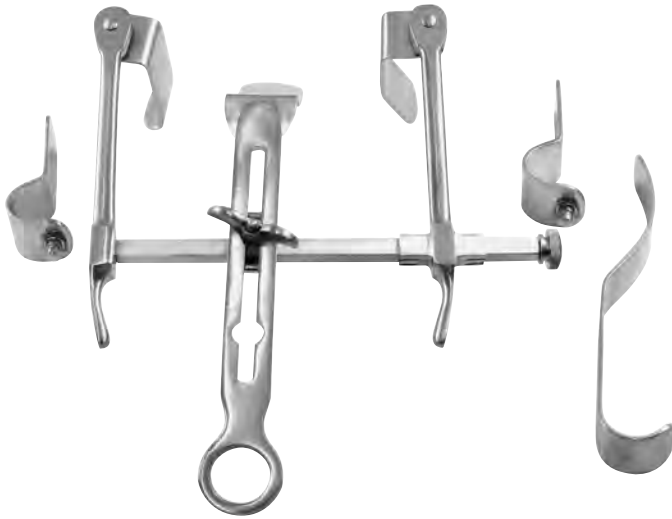

THOMSON-WALKER
170-182-00

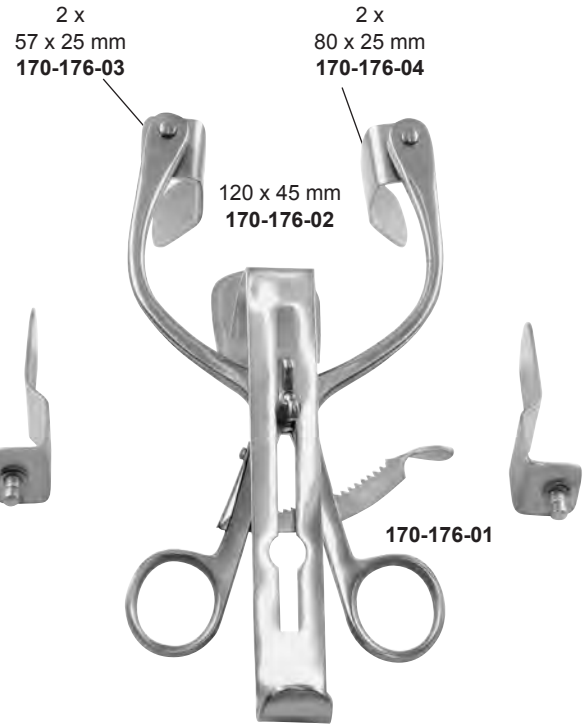

MILLIN
170-176-00

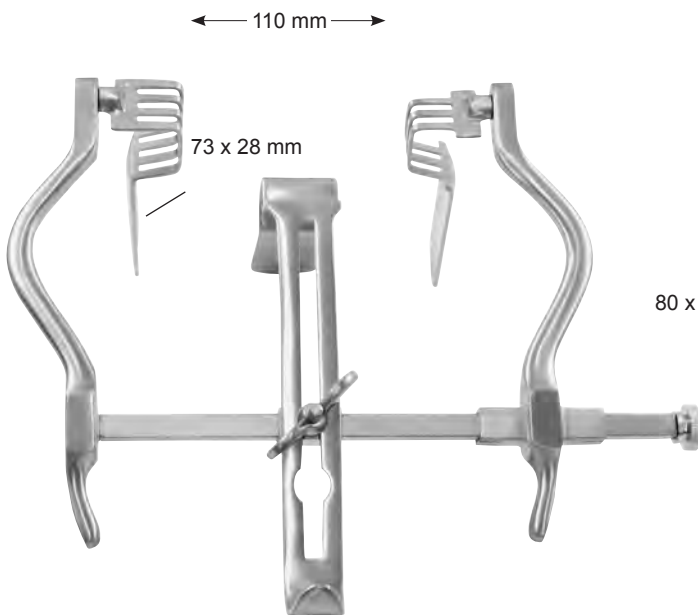

JUDD-MASSON
170-172-00

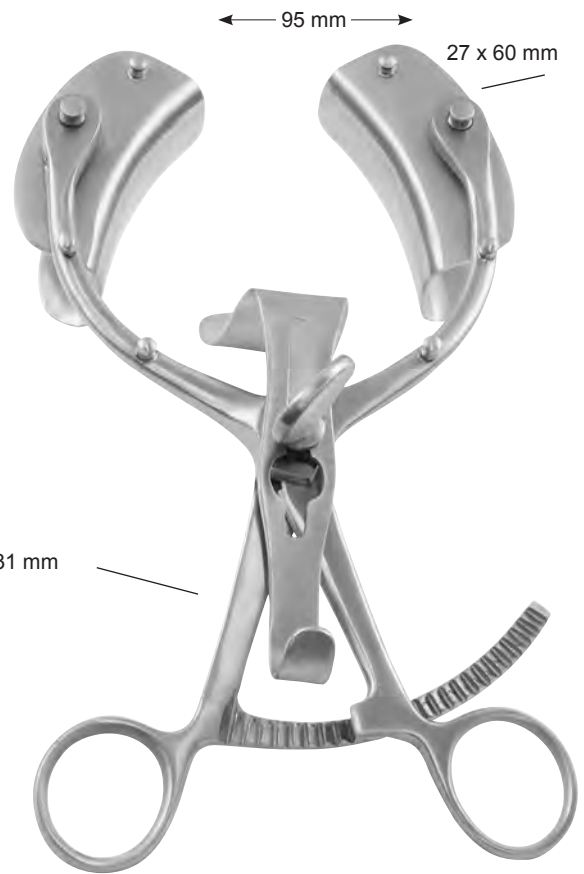

LEGUEU
170-160-00



MILLIN
23,0 cm, 9"
170-073-23



MILLIN
24,0 cm, 9½"
170-071-24



MILLIN
24,0 cm, 9½"
170-077-24



MILLIN
23,0 cm, 9"
170-075-23



MILLIN
28,5 cm, 11¼"
170-150-24

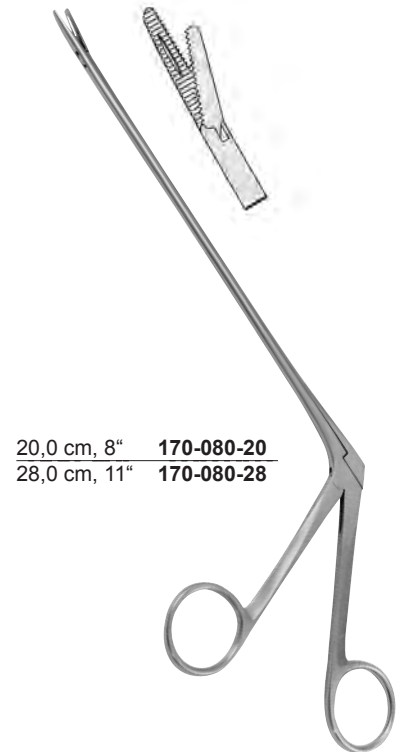

20,0 cm, 8" **170-080-20**
28,0 cm, 11" **170-080-28**

MATHIEU



YOUNG
21,0 cm, 8¹/₄"
170-230-21



YOUNG
22,0 cm, 8⁵/₈"
170-236-22



YOUNG
21,0 cm, 8¹/₄"
170-238-21



YOUNG
22,0 cm, 8⁵/₈"
170-240-22



90 x 35 mm

LEGUEU
26,0 cm, 10¹/₄"
170-250-26



90 x 61 mm

KOCHER
23,5 cm, 9¹/₄"
170-257-23



für Männer
for men
para hombres
per uomini

Char. 8	170-650-08
Char. 10	170-650-10
Char. 12	170-650-12
Char. 14	170-650-14
Char. 16	170-650-16
Char. 18	170-650-18
Char. 20	170-650-20
Char. 22	170-650-22
Char. 24	170-650-24

29,0 cm, 11 1/2"



für Frauen
for women
para mujeres
per donne

Char. 6	170-660-06
Char. 7	170-660-07
Char. 8	170-660-08
Char. 9	170-660-09
Char. 10	170-660-10
Char. 11	170-660-11
Char. 12	170-660-12
Char. 13	170-660-14
Char. 15	170-660-15
Char. 16	170-660-16
Char. 18	170-660-18
Char. 20	170-660-20
Char. 24	170-660-24

16,0 cm, 6 1/4"



STRAUSS
11,0 cm, 4 1/3"
170-349-11



STOCKMANN
8,0 cm, 3 1/4"
170-345-08



COMCO

Ø 8,0 mm	170-350-08
Ø 11,0 mm	170-350-11
Ø 13,0 mm	170-350-13
Ø 16,0 mm	170-350-16
Ø 21,0 mm	170-350-21
Ø 26,0 mm	170-350-26
Ø 32,0 mm	170-350-32

Stomach, Intestines, Rectum

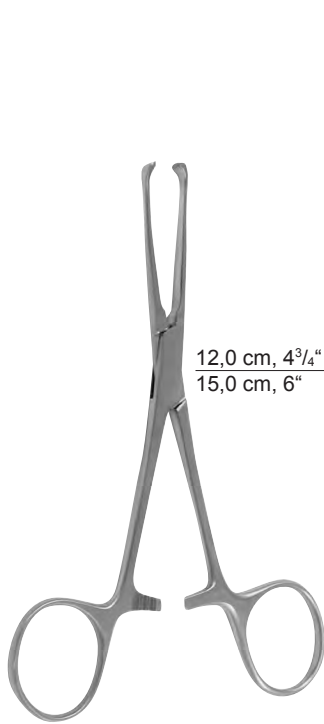

12,0 cm, 4³/₄" **160-000-12**
 15,0 cm, 6" **160-000-15**

ALLIS-BABY

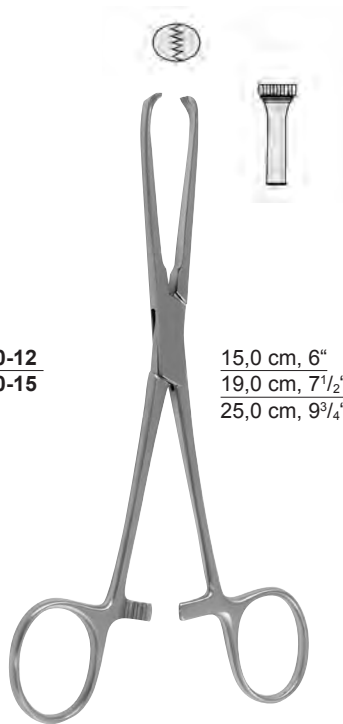

15,0 cm, 6" **160-004-15**
 19,0 cm, 7¹/₂" **160-004-19**
 25,0 cm, 9³/₄" **160-004-25**

ALLIS

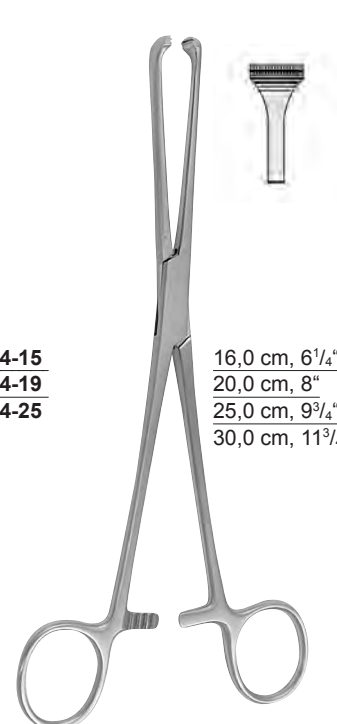

16,0 cm, 6¹/₄" **160-124-16**
 20,0 cm, 8" **160-124-20**
 25,0 cm, 9³/₄" **160-124-25**
 30,0 cm, 11³/₄" **160-124-30**

ALLIS-ATRAUMA



15,5 cm, 6" **160-020-15**
 20,0 cm, 8" **160-020-20**
 23,0 cm, 9" **160-020-23**

ALLEN

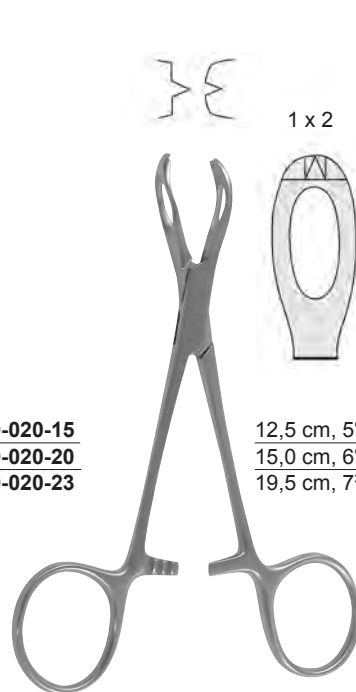

12,5 cm, 5" **160-030-12**
 15,0 cm, 6" **160-030-15**
 19,5 cm, 7³/₄" **160-030-19**

LANE

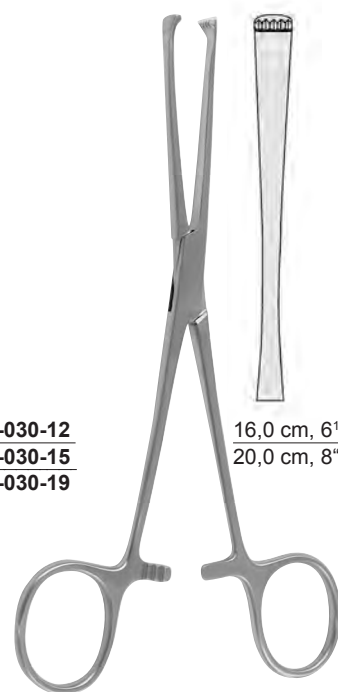

16,0 cm, 6¹/₄" **160-178-16**
 20,0 cm, 8" **160-178-20**

LOCKWOOD-ALLIS



JUDD-ALLIS



LITTLEWOOD
18,5 cm, 7 1/4"
160-060-16



ALLIS-ADAIR
15,5 cm, 6"
160-010-15



BOYS-ALLIS
15,5 cm, 6"
160-012-15



THOMS-ALLIS
20,0 cm, 8"
160-050-20



ALLIS
20,0 cm, 8"
160-014-20



LOCKWOOD
20,0 cm, 8"
160-169-20



WILLIAMS
16,0 cm, 6 1/4"
160-070-16



16,0 cm, 6 1/4" **160-006-16**
18,0 cm, 7" **160-006-18**
20,0 cm, 8" **160-006-20**
24,0 cm, 9 1/2" **160-006-24**



16,0 cm, 6 1/4" **164-006-16**
20,0 cm, 8" **164-006-20**

BABCOCK-ATRAUMA



16,0 cm, 6 1/4" **161-006-16**
20,0 cm, 8" **161-006-20**

BABCOCK-T C



DUVAL-TC
20,0 cm, 8"
161-170-20

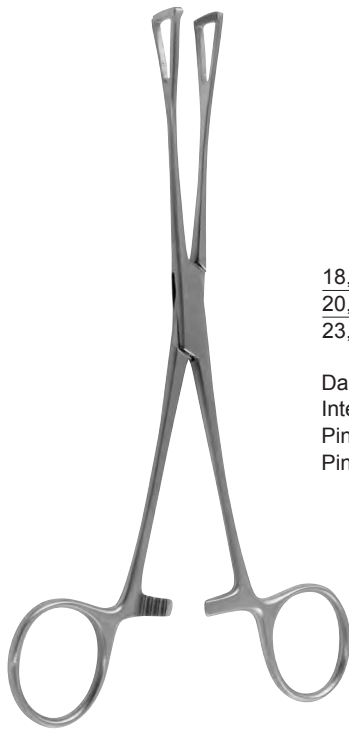

DUVAL

18,0 cm, 7"	160-170-18	
20,0 cm, 8"	160-170-20	160-172-20
23,0 cm, 9"		160-172-23

Darm- und Gewebefaßzangen
 Intestinal and Tissue Grasping Forceps
 Pinzas intestinales y para tejidos
 Pinze da presa per intestino e tessuti



BABY-DOYEN
 18,0 cm, 7"

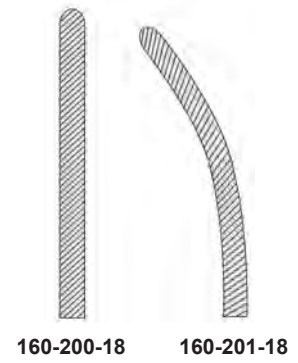

160-200-18

160-201-18



DOYEN

21,0 cm, 8 ¹ / ₄ "	160-210-21
23,0 cm, 9"	160-210-23

21,0 cm, 8 ¹ / ₄ "	160-211-21
23,0 cm, 9"	160-211-23

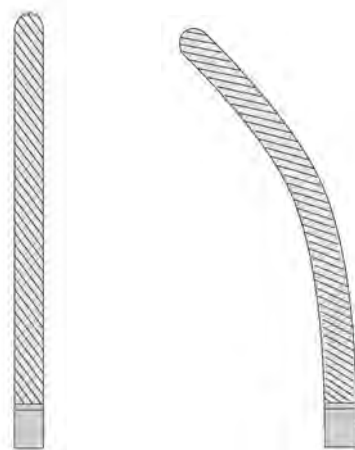



DOYEN



21,0 cm, 8¹/₄" **164-210-21**
23,0 cm, 9" **164-210-23**

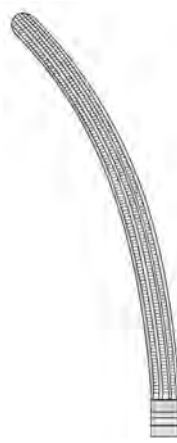

21,0 cm, 8¹/₄" **164-211-21**
23,0 cm, 9" **164-211-23**

mit atraumatischer Zahnung
with atraumatic serration
con bacos atraumáticos
con morsi atraumatici



KOCHER



22,0 cm, 8⁵/₈" **160-234-22**
25,0 cm, 9³/₄" **160-234-25**
28,0 cm, 11" **160-234-28**



22,0 cm, 8⁵/₈" **160-235-22**
25,0 cm, 9³/₄" **160-235-25**
28,0 cm, 11" **160-235-28**



mit atraumatischer Zahnung
with atraumatic serration
con bacos atraumáticas
con morsi atraumatici

KOCHER

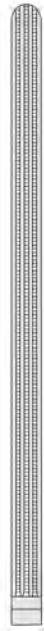

22,0 cm, 8 ⁵ / ₈ "	164-234-22	22,0 cm, 8 ⁵ / ₈ "	164-235-22
25,0 cm, 9 ³ / ₄ "	164-234-25	25,0 cm, 9 ³ / ₄ "	164-235-25
28,0 cm, 11"	164-234-28	28,0 cm, 11"	164-235-28



MAYO-ROBSON

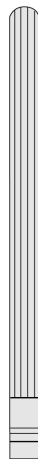

21,0 cm, 8 ¹ / ₄ "	160-230-21	21,0 cm, 8 ¹ / ₄ "	160-231-21
23,0 cm, 9"	160-230-23	23,0 cm, 9"	160-231-23
25,0 cm, 9 ³ / ₄ "	160-230-25	25,0 cm, 9 ³ / ₄ "	160-231-25

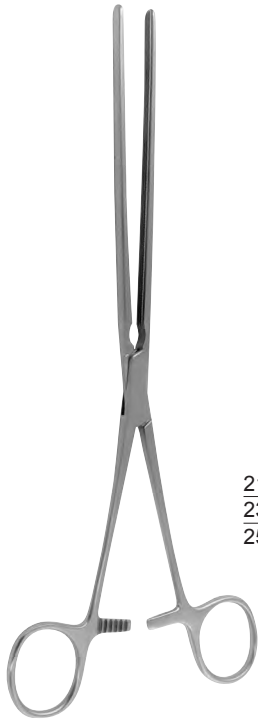

MAYO-ROBSON

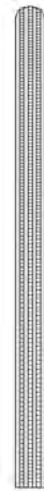

21,0 cm, 8¹/₄" **164-230-21**
 23,0 cm, 9" **164-230-23**
 25,0 cm, 9³/₄" **164-230-25**



21,0 cm, 8¹/₄" **164-231-21**
 23,0 cm, 9" **164-231-23**
 25,0 cm, 9³/₄" **164-231-25**

mit atraumatischer Zahnung
 with atraumatic serration
 con bacos atraumáticos
 con morsi atraumatici

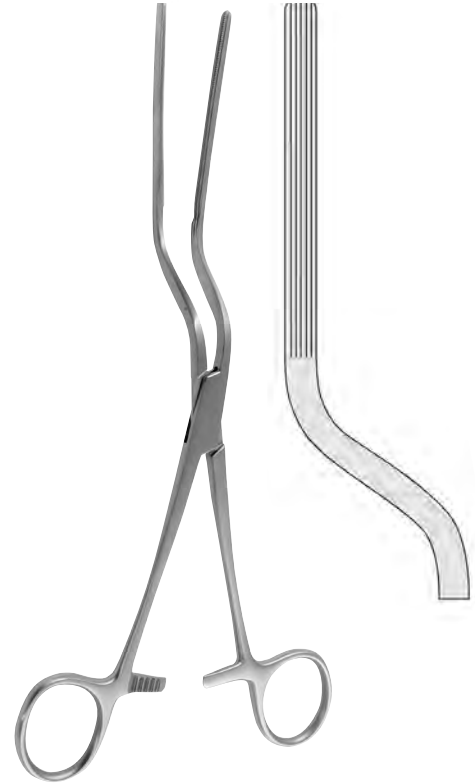

BRUNNER
 24,0 cm, 9¹/₂"
160-240-24

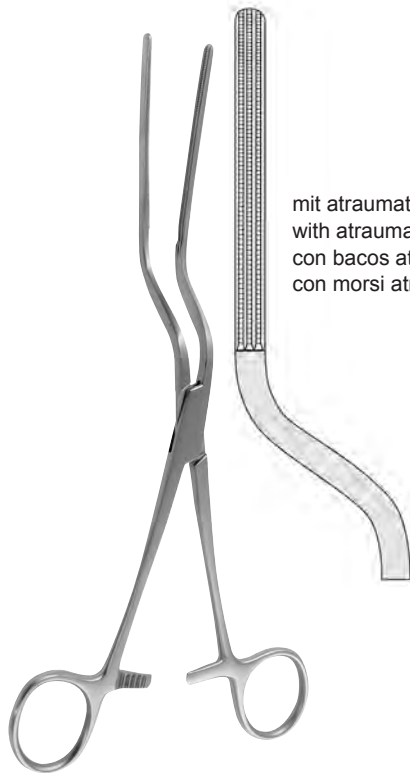

BRUNNER
 24,0 cm, 9¹/₂"
164-240-24

mit atraumatischer Zahnung
 with atraumatic serration
 con bacos atraumáticos
 con morsi atraumatici

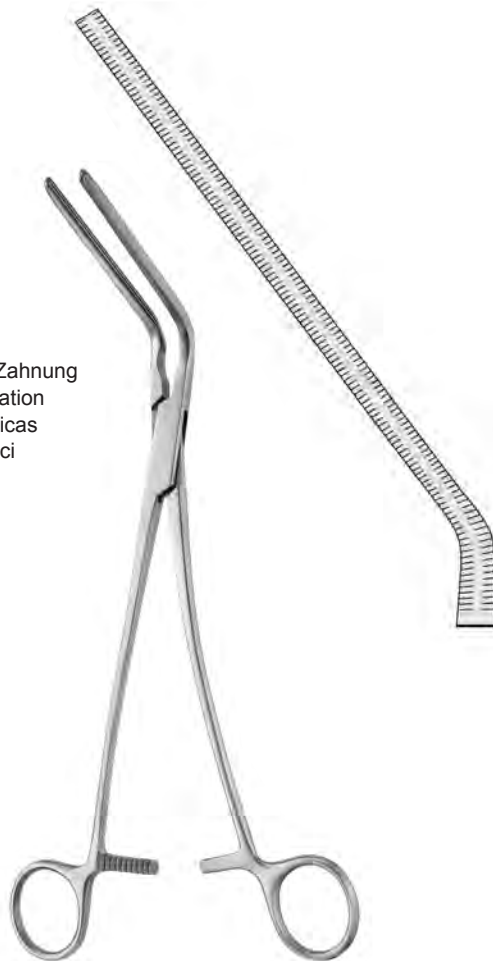

GLASSMAN
 23,0 cm, 9"
160-259-23

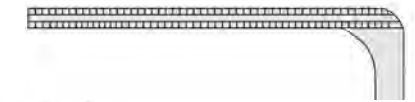

GLASSMAN
 23,5 cm, 9¹/₄"
160-253-23



Maullänge
length of jaws
longitud de la boca
bocche lungh

5,0 cm, 2"	160-320-05
7,0 cm, 2 1/2"	160-320-07
10,0 cm, 4"	160-320-10

DE MARTEL-WOLFSON



DE MARTEL-WOLFSON
8,5 cm, 3 1/2"
160-340-08



DE MARTEL-WOLFSON
26,0 cm, 10 1/4"
160-325-26



BABY-PAYR
15,0 cm, 6"

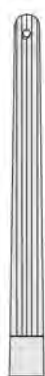

160-310-15
mit Stift
with pin
con espiga
con perno



160-311-15
ohne Stift
without pin
sin espiga
senza perno

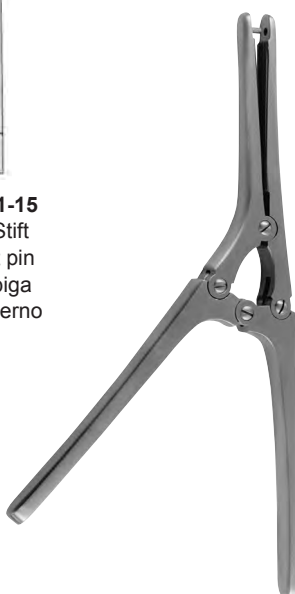

PAYR



21,0 cm, 8 1/4" **160-310-21** **160-311-21**
29,0 cm, 11 1/2" **160-310-29** **160-311-29**



mit Stift with pin con espiga con perno	ohne Stift without pin sin espiga senza perno
--	--



160-360-30

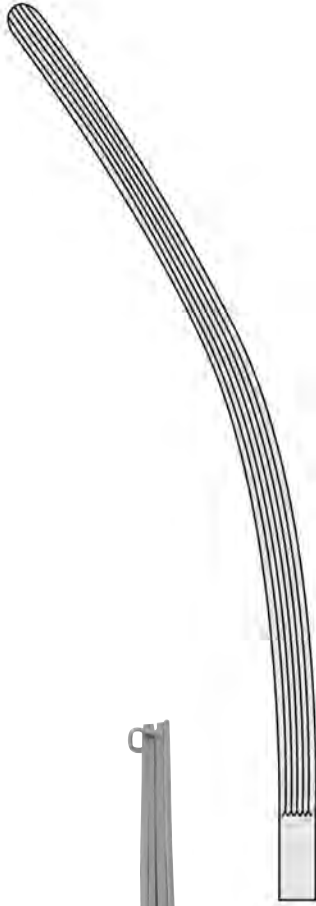

160-361-30



160-364-33

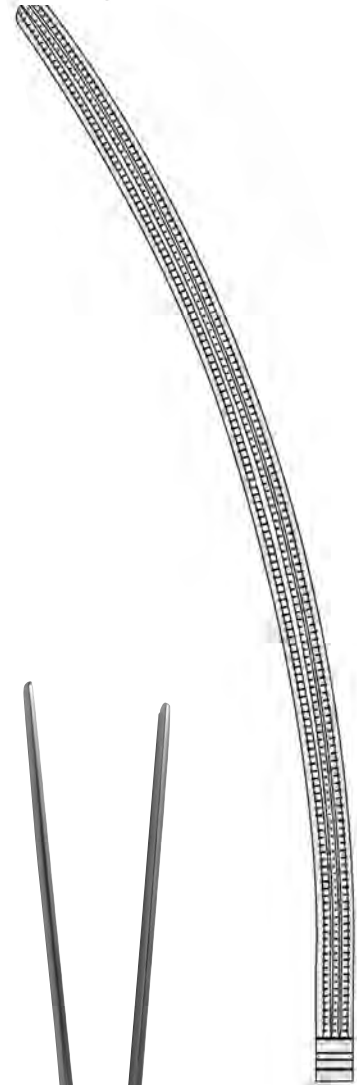

160-365-33

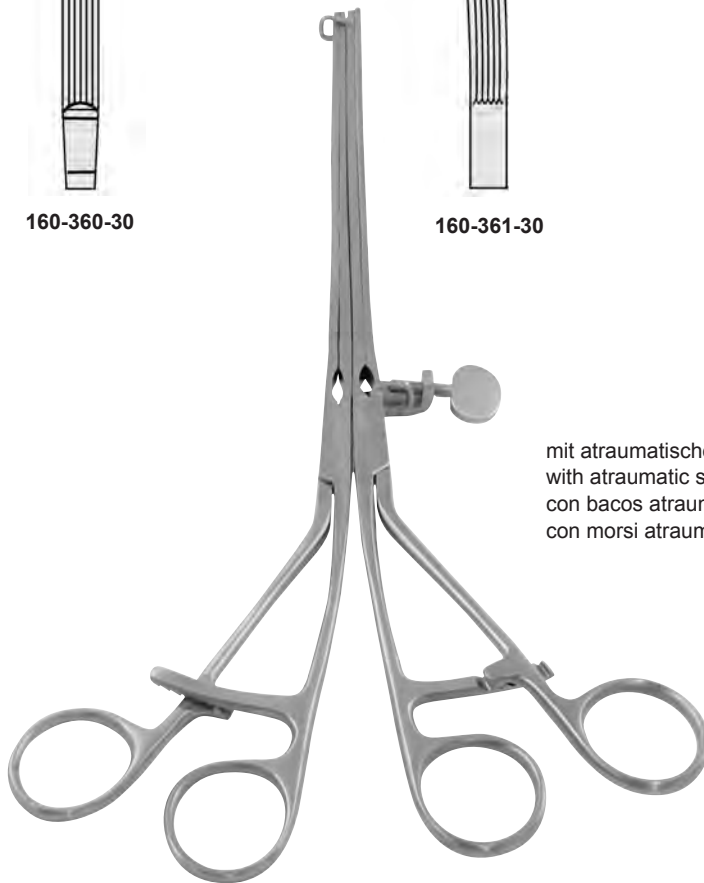

LANE
30,0 cm, 11³/₄"

mit atraumatischer Zahnung
with atraumatic serration
con bacos atraumáticas
con morsi atraumatici



SCUDDER
33,0 cm, 13"



MIKULICZ
19,0 cm, 7½"
168-010-19

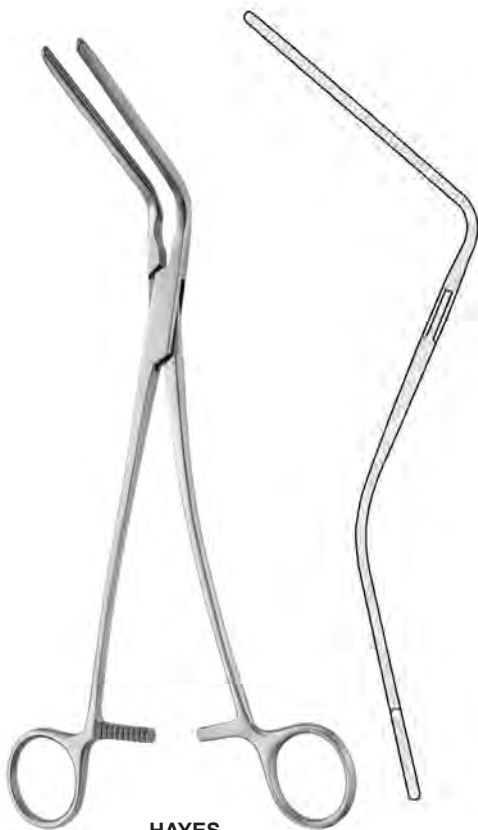
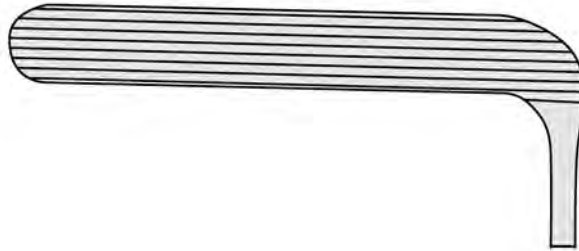

HAYES

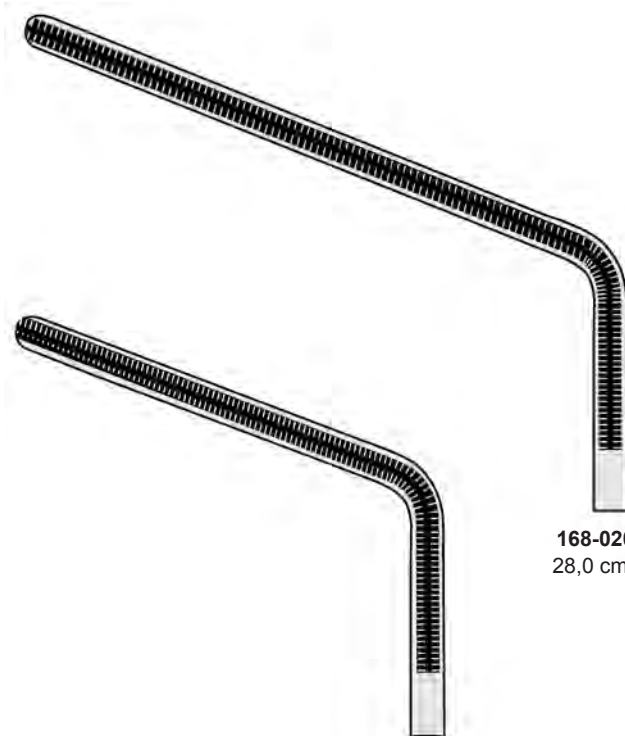

168-020-28
28,0 cm, 11"

168-020-26
26,0 cm, 10"

Rectal Specula

17 x 89 mm



SIMS
15,0 cm, 6"
168-108-15

17 x 89 mm



SIMS
15,0 cm, 6"
168-110-15

25 x 89 mm



MATHIEU
21,0 cm, 8 1/4"
168-150-21

75 x 23 mm

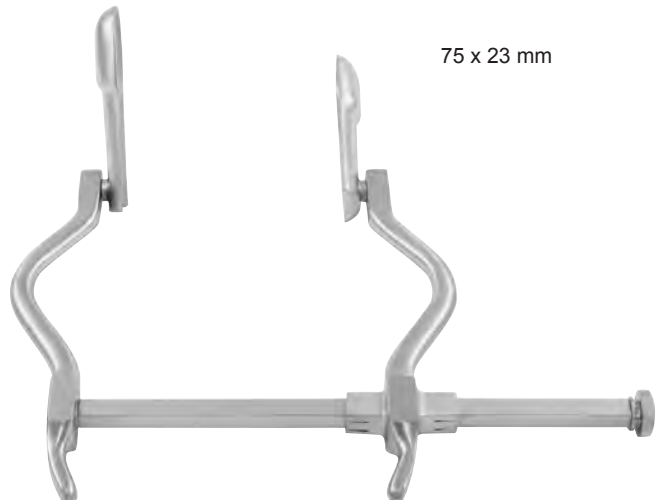

SMITH-BUIE
15,0 cm, 6"
168-160-15

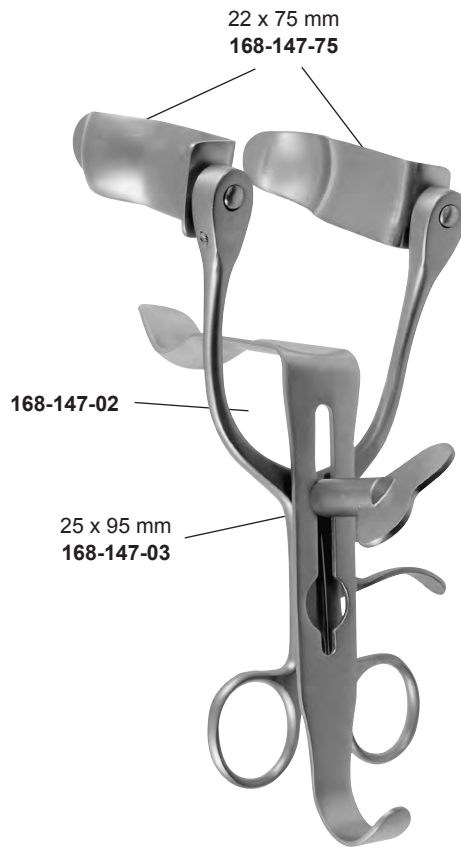

ALAN PARKS
13,5 cm, 5³/₈"
168-147-00

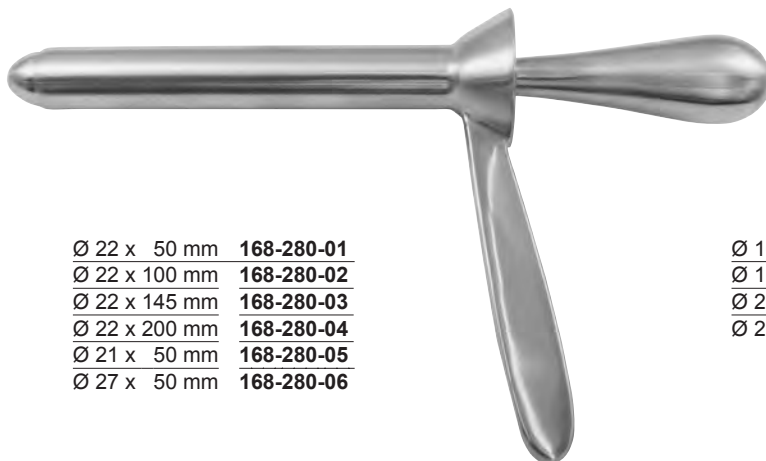

Ø 22 x 50 mm **168-280-01**
Ø 22 x 100 mm **168-280-02**
Ø 22 x 145 mm **168-280-03**
Ø 22 x 200 mm **168-280-04**
Ø 21 x 50 mm **168-280-05**
Ø 27 x 50 mm **168-280-06**

HAYES

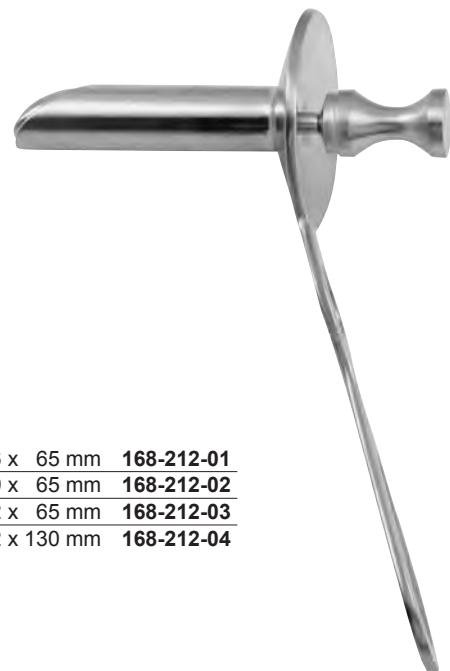

Ø 16 x 65 mm **168-212-01**
Ø 19 x 65 mm **168-212-02**
Ø 22 x 65 mm **168-212-03**
Ø 22 x 130 mm **168-212-04**

HIRSCHMANN



Ø 22 x 65 mm **168-250-22**
Ø 30 x 65 mm **168-250-30**

CHELSEA EATON



ohne Kaltlichtträger
without cold light carrier
sin portador para luz fría
senza luce fredda

IVES FANSLER
Ø 22 mm
168-268-01

mit Kaltlichtträger
with cold light carrier
con portador para luz fría
con luce fredda

IVES FANSLER
Ø 22 mm
168-268-02



28,0 cm, 11" **168-300-28**
 35,0 cm, 13³/₄" **168-300-35**
 42,0 cm, 16¹/₂" **168-300-42**



28,0 cm, 11" **168-311-28**
 35,0 cm, 13³/₄" **168-311-35**
 42,0 cm, 16¹/₂" **168-311-42**



28,0 cm, 11" **168-301-28**
 35,0 cm, 13³/₄" **168-301-35**
 42,0 cm, 16¹/₂" **168-301-42**



28,0 cm, 11" **168-312-28**
 35,0 cm, 13³/₄" **168-312-35**
 42,0 cm, 16¹/₂" **168-312-42**

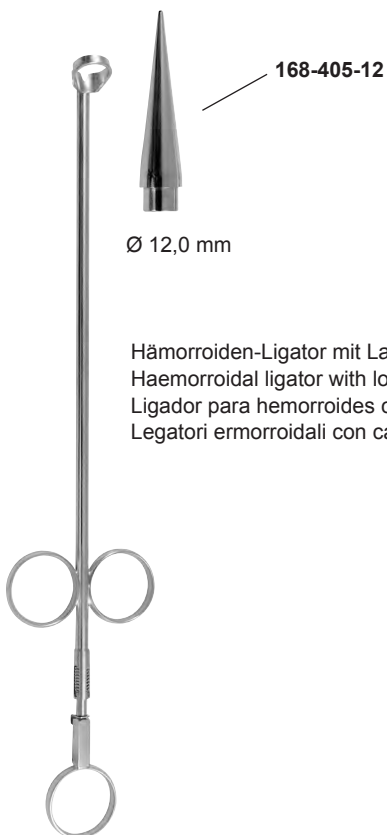

Ø 12,0 mm

Hämorrhoiden-Ligator mit Ladekonus
 Haemorrhoidal ligator with loading attachment
 Ligador para hemorroides con cono de carga
 Legatori emorroidali con carica a cono

RUDD
168-400-00



Ø 12,0 mm

Hämorrhoiden-Ligator mit Ladekonus
 Haemorrhoidal ligator with loading attachment
 Ligador para hemorroides con cono de carga
 Legatori emorroidali con carica a cono

MC GIVNEY
168-410-00

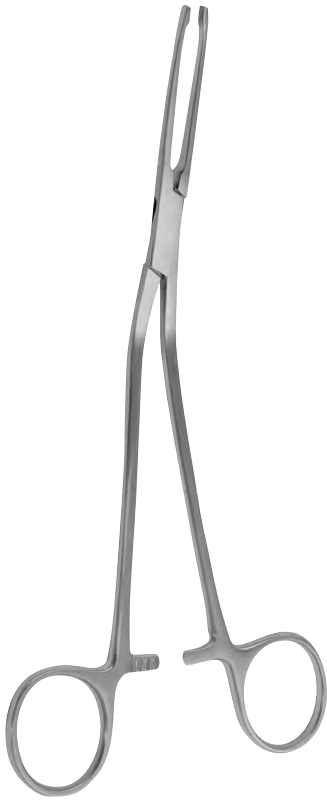

MC GIVNEY
19,0 cm, 7 1/2"
168-471-19



MC GIVNEY
19,0 cm, 7 1/2"
168-473-19



PRATT
21,0 cm, 8 1/4"



080-135-01



080-135-02



080-135-03

Gynecology, Obstetrics

für Jungfrauen
for virgins
para virgenes
per vergini



COLLIN
65 x 10 mm
180-132-00

für Kinder
for children
para niños
per bambini



COLLIN
65 x 10 mm
180-134-00

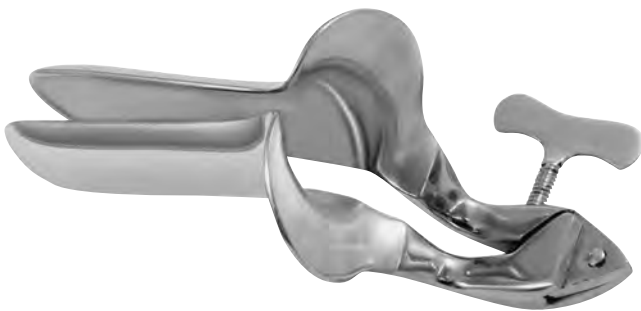

COLLIN

85 x 30 mm	180-130-01
100 x 35 mm	180-130-02
110 x 40 mm	180-130-03



80 x 24 mm	180-142-01
80 x 32 mm	180-142-02
98 x 16 mm	180-142-03
105 x 25 mm	180-142-04
107 x 29 mm	180-142-05
115 x 35 mm	180-142-06

zentrale Stellschraube
 central fixation screw
 tornillo de sujeto central
 vite di regolazione centrale



CUSCO

75 x 32 mm	180-144-01
85 x 36 mm	180-144-02
95 x 37 mm	180-144-03

seitliche Stellschraube
 lateral fixation screw
 tornillo de sujeto lateral
 vite di regolazione laterale



für Jungfrauen
 for virgins
 para virgenes
 per vergini

CUSCO
 75 x 17 mm
180-140-00

seitliche Stellschraube
 lateral fixation screw
 tornillo de sujeto lateral
 vite di regolazione laterale



CUSCO

75 x 32 mm	180-140-01
85 x 35 mm	180-140-02
100 x 35 mm	180-140-03

Schweizer Modell
 Swiss pattern
 Modelo suizo
 Modello svizzero



CUSCO

90 x 23-25 mm	180-146-01
100 x 25-27 mm	180-146-02
110 x 27-30 mm	180-146-03



GRAVE

75 x 20 mm	180-100-01
95 x 35 mm	180-100-02
115 x 35 mm	180-100-03



PEDERSON

75 x 13 mm	180-120-01
100 x 22 mm	180-120-02
120 x 25 mm	180-120-03



SEMM

90 x 14-18 mm	180-150-01
100 x 17-20 mm	180-150-02
100 x 25-30 mm	180-150-03



WEISSBARTH
21,0 cm, 8¹/₄"
180-160-00



mit abnehmbarem Gewicht
with detachable weight
con peso desmontable
con peso smontabile

1,14 kg

AUVARD
75 x 38 mm
180-170-00



mit festem Gewicht
with fixed weight
con peso fijo
con peso fiso

1,14 kg

AUVARD
75 x 38 mm
180-172-00

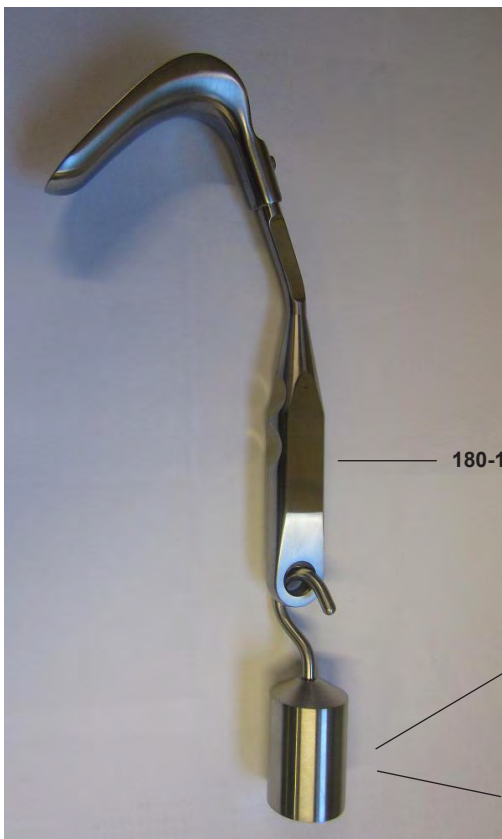

180-180-03

400 g
180-180-40

800 g
180-180-80

SCHERBACK
180-180-00

koplett, complete, completo, completo

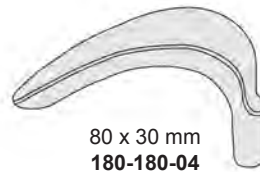

80 x 30 mm
180-180-04

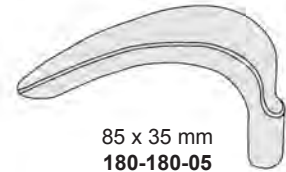

85 x 35 mm
180-180-05

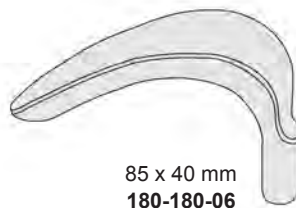

85 x 40 mm
180-180-06



55 x 40-60 mm
180-180-07



70 x 45-70 mm
180-180-08



Satz
Set
Juego
Set

KRISTELLER

Fig. 1 **180-220-01**
Fig. 2 **180-220-02**
Fig. 3 **180-220-03**



Spekula allein, flach
Specula only, flat hollow
Espéculos suelto, con huecos planos
Solo speculi, piatta

KRISTELLER

105 x 26 mm **180-221-01**
105 x 28 mm **180-221-02**
105 x 33 mm **180-221-03**

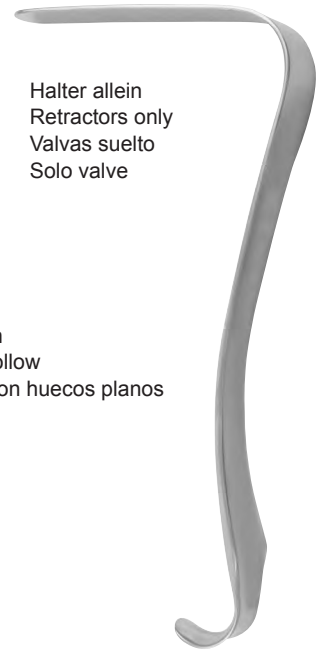

Halter allein
Retractors only
Valvas suelto
Solo valve

KRISTELLER

115 x 22 mm **180-222-01**
115 x 24 mm **180-222-02**
115 x 29 mm **180-222-03**



Satz
Set
Juego
Set

KRISTELLER

Fig. 1 **180-230-01**
Fig. 2 **180-230-02**
Fig. 3 **180-230-03**

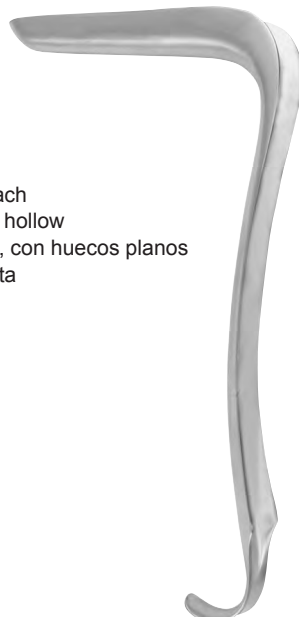

Spekula allein, flach
Specula only, flat hollow
Espéculos suelto, con huecos planos
Solo speculi, piatta

KRISTELLER

110 x 27 mm **180-231-01**
110 x 30 mm **180-231-02**
110 x 36 mm **180-231-03**



Halter allein
Retractors only
Valvas suelto
Solo valve

KRISTELLER

115 x 23 mm **180-232-01**
115 x 26 mm **180-232-02**
115 x 32 mm **180-232-03**



Satz
Set
Juego
Set

KRISTELLER	
Fig. 0	180-234-00
Fig. 1	180-234-01
Fig. 2	180-234-02
Fig. 3	180-234-03



Spekula allein
Specula only
Espéculos suelto
Solo speculi

KRISTELLER	
70 x 15 mm	180-235-00
70 x 27 mm	180-235-01
80 x 30 mm	180-235-02
90 x 36 mm	180-235-03

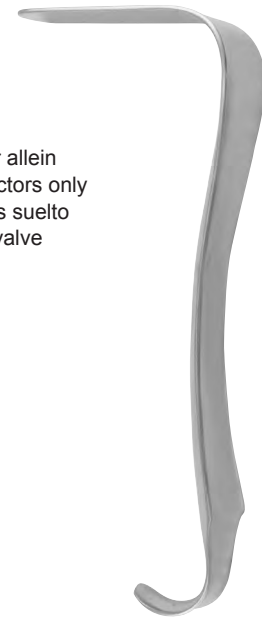

Halter allein
Retractors only
Valvas suelto
Solo valve

KRISTELLER	
75 x 10 mm	180-236-00
75 x 23 mm	180-236-01
85 x 26 mm	180-236-02
100 x 32 mm	180-236-03



konisch, für Jungfrauen
conical blades, for virgins
valvas cónicas, para vírgenes
valve coniche, per vergini

KRISTELLER	
Fig. 00	180-237-01
Fig. 0	180-237-02



Spekula allein
Specula only
Espéculos suelto
Solo speculi

KRISTELLER	
105 x 18 mm	180-238-01
105 x 21 mm	180-238-02

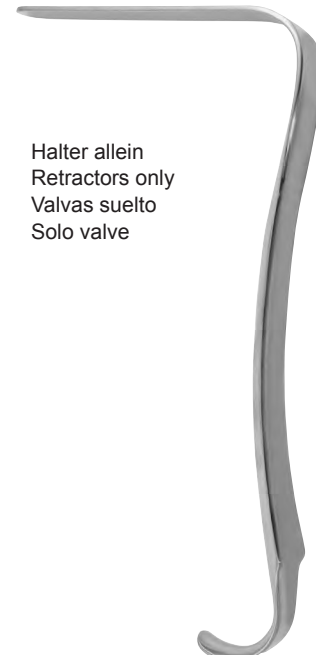

Halter allein
Retractors only
Valvas suelto
Solo valve

KRISTELLER	
110 x 14 mm	180-239-01
110 x 17 mm	180-239-02

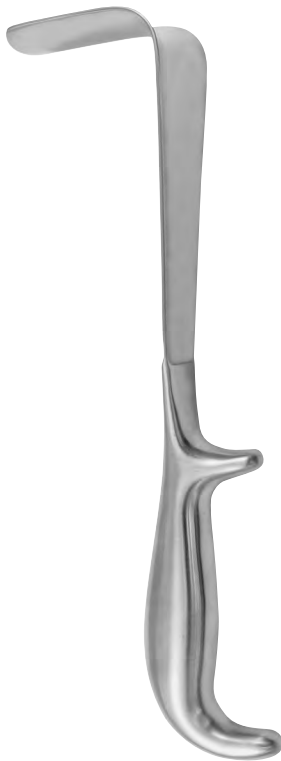

leicht hohl
slightly-concave
ligeremente concavos
leggeremente concavi

Fig	a x b	
1	55 x 35 mm	180-260-01
2	85 x 35 mm	180-260-02
3	115 x 35 mm	180-260-03

1	55 x 45 mm	180-261-01
2	85 x 45 mm	180-261-02
3	115 x 45 mm	180-261-03
4	160 x 45 mm	180-261-04

1	55 x 60 mm	180-262-01
2	85 x 60 mm	180-262-02
3	115 x 60 mm	180-262-03
4	160 x 60 mm	180-262-04

DOYEN
23,0 cm, 9"



halb-hohl
medium-concave
semi-concavos
semi-concavi

Fig	a x b	
1	55 x 35 mm	180-264-01
2	85 x 35 mm	180-264-02
3	115 x 35 mm	180-264-03

1	55 x 45 mm	180-265-01
2	85 x 45 mm	180-265-02
3	115 x 45 mm	180-265-03

1	55 x 60 mm	180-266-01
2	85 x 60 mm	180-266-02
3	115 x 60 mm	180-266-03

DOYEN
23,0 cm, 9"

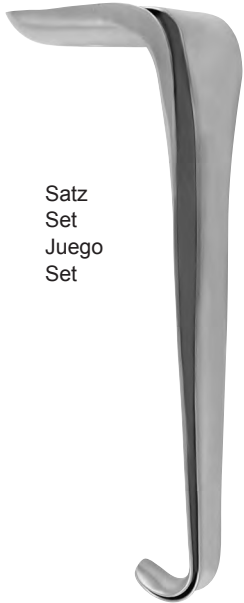

Satz
Set
Juego
Set

KALLMORGEN

70 x 40 mm	180-270-01
90 x 40 mm	180-270-02



Spekula allein
Specula only
Especulos suelto
Solo speculi

KALLMORGEN

70 x 40 mm	180-271-01
90 x 40 mm	180-271-02

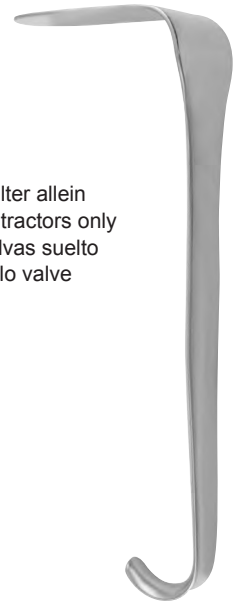

Halter allein
Retractors only
Valvas suelto
Solo valve

KALLMORGEN

70 x 40 mm	180-272-01
90 x 40 mm	180-272-02



70 x 15 mm

KRISTELLER

17,0 cm, 6³/₄"
180-275-17

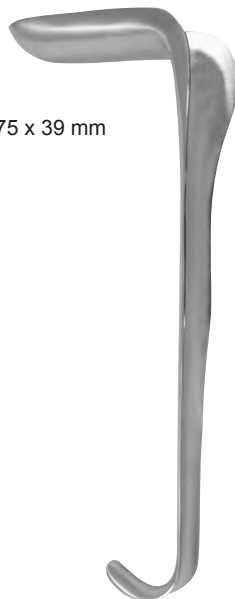

75 x 39 mm

KALLMORGEN

17,0 cm, 6³/₄"
180-290-17



JACKSON

75 x 38 mm	180-290-01
90 x 38 mm	180-290-02
100 x 38 mm	180-290-03

76 x 25 mm



70 x 22 mm

BREISKY
14,0 cm, 5½"
180-292-01

82 x 30 mm



76 x 25 mm

BREISKY
14,0 cm, 5½"
180-292-02

95 x 38 mm

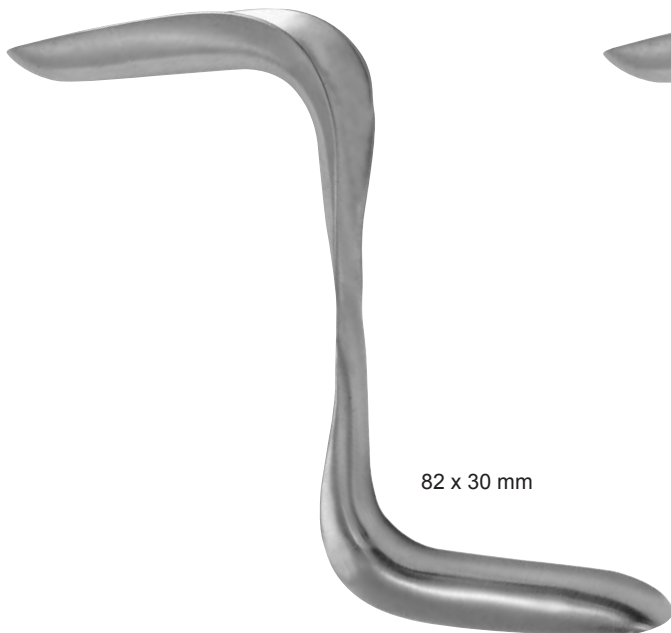

82 x 30 mm

BREISKY
17,0 cm, 6¾"
180-292-03

102 x 44 mm

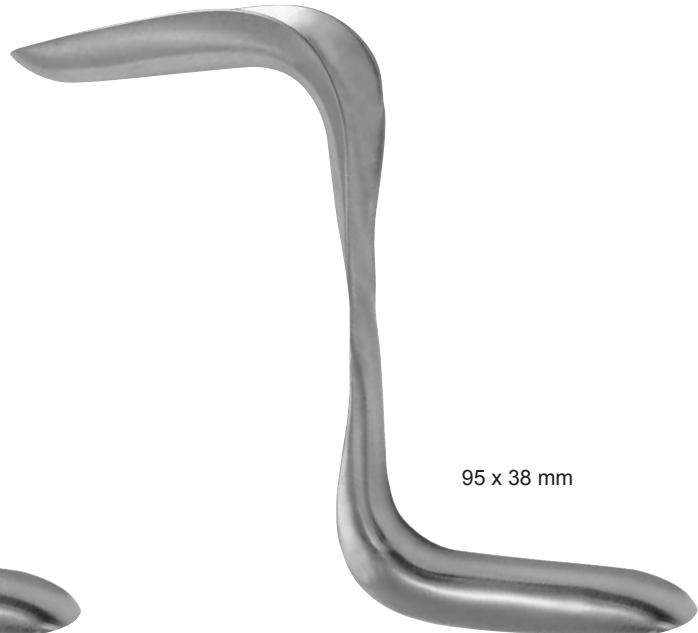

95 x 38 mm

BREISKY
17,0 cm, 6¾"
180-292-04

SIMS
57-8294-00
Satz, Set, Juego, Set, набор

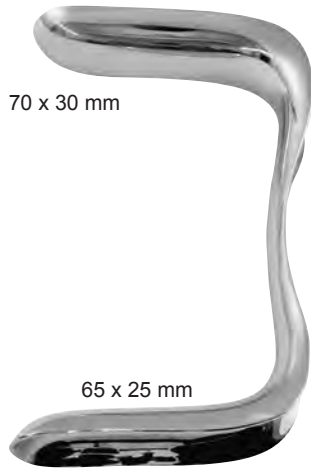

SIMS
12,5 cm, 5"
180-294-01



SIMS
15,0 cm, 6"
180-294-02

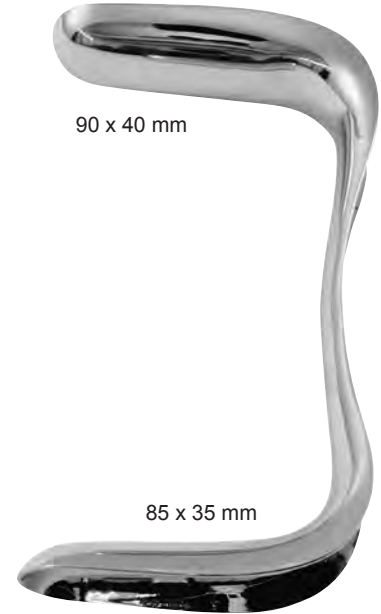

SIMS
17,5 cm, 7"
180-294-03

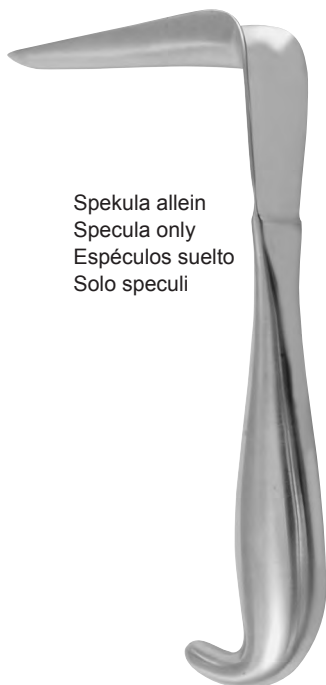

MATHIEU
100 x 13-23 mm **180-300-01**
100 x 16-30 mm **180-300-02**



MATHIEU
100 x 11-21 mm **180-301-01**
100 x 14-27 mm **180-301-02**



LANDAU
100 x 28 mm **180-305-01**
100 x 38 mm **180-305-02**

Vaginal Specula



100 x 20 mm	180-307-20
100 x 25 mm	180-307-25
100 x 30 mm	180-307-30
100 x 35 mm	180-307-35
100 x 40 mm	180-307-40
<hr/>	
130 x 20 mm	180-308-20
130 x 25 mm	180-308-25
130 x 30 mm	180-308-30
130 x 35 mm	180-308-35
130 x 40 mm	180-308-40
<hr/>	
155 x 40 mm	180-309-40

BREISKY



BRAUN, MODIF.
19,0 cm, 7 1/2"
180-313-19



DOYEN
23,0 cm, 9"
180-315-23



DOYEN
25,0 cm, 9"
180-315-25



WERTHEIM
30,0 cm, 12"
180-317-30



3,0 mm

180-092-03

4,0 mm

180-092-04

5,0 mm

KOGAN
24,0 cm, 9 1/2"

180-092-05



3,0 mm

180-090-03

4,0 mm

180-090-04

5,0 mm

KOGAN
24,0 cm, 9 1/2"

180-090-05



Ø 1,0 mm	180-350-01
Ø 2,0 mm	180-350-02
Ø 3,0 mm	180-350-03
Ø 4,0 mm	180-350-04
Ø 5,0 mm	180-350-05
Ø 6,0 mm	180-350-06
Ø 7,0 mm	180-350-07
Ø 8,0 mm	180-350-08
Ø 9,0 mm	180-350-09
Ø 10,0 mm	180-350-10
Ø 11,0 mm	180-350-11
Ø 12,0 mm	180-350-12
Ø 13,0 mm	180-350-13
Ø 14,0 mm	180-350-14
Ø 15,0 mm	180-350-15
Ø 16,0 mm	180-350-16
Ø 17,0 mm	180-350-17
Ø 18,0 mm	180-350-18
Ø 19,0 mm	180-350-19
Ø 20,0 mm	180-350-20
Ø 21,0 mm	180-350-21
Ø 22,0 mm	180-350-22
Ø 23,0 mm	180-350-23
Ø 24,0 mm	180-350-24
Ø 25,0 mm	180-350-25
Ø 26,0 mm	180-350-26

HEGAR
18,5 cm, 7¼"



Ø 1,5 mm	180-351-01
Ø 2,5 mm	180-351-02
Ø 3,5 mm	180-351-03
Ø 4,5 mm	180-351-04
Ø 5,5 mm	180-351-05
Ø 6,5 mm	180-351-06
Ø 7,5 mm	180-351-07
Ø 8,5 mm	180-351-08
Ø 9,5 mm	180-351-09
Ø 10,5 mm	180-351-10
Ø 11,5 mm	180-351-11
Ø 12,5 mm	180-351-12
Ø 13,5 mm	180-351-13
Ø 14,5 mm	180-351-14
Ø 15,5 mm	180-351-15
Ø 16,5 mm	180-351-16
Ø 17,5 mm	180-351-17

HEGAR
18,5 cm, 7¼"



205 x 105 x 45 mm

HEGAR
180-350-99
Satz, Set, Juego, Set
Ø 1,0 - Ø 26,0
(26 dilators)

HEGAR
180-350-98
Satz, Set, Juego, Set
Ø 4,0 - Ø 17,0
(14 dilators)



HEGAR
20,0 cm, 8"

Ø 1,0 / 2,0 mm	180-354-01
Ø 3,0 / 4,0 mm	180-354-03
Ø 5,0 / 6,0 mm	180-354-05
Ø 7,0 / 8,0 mm	180-354-07
Ø 9,0 / 10,0 mm	180-354-09
Ø 11,0 / 12,0 mm	180-354-11
Ø 13,0 / 14,0 mm	180-354-13
Ø 15,0 / 16,0 mm	180-354-15
Ø 17,0 / 18,0 mm	180-354-17
Ø 19,0 / 20,0 mm	180-354-19
Ø 21,0 / 22,0 mm	180-354-21
Ø 23,0 / 24,0 mm	180-354-23
Ø 25,0 / 26,0 mm	180-354-25



HEGAR
180-354-98
Satz, Set, Juego, Set
Ø 3,0 / 4,0 - Ø 17,0 / 18,0 mm
(8 dilators)

HEGAR
180-354-99
Satz, Set, Juego, Set
Ø 1,0 / 2,0 - Ø 25,0 / 26,0 mm
(13 dilators)



HANK

Ø 4,5 / 5,0 mm	180-360-05
Ø 5,5 / 6,0 mm	180-360-06
Ø 6,5 / 7,0 mm	180-360-07
Ø 7,5 / 8,0 mm	180-360-08
Ø 8,5 / 9,0 mm	180-360-09
Ø 9,5 / 10,0 mm	180-360-10



HANK
180-360-98
Satz, Set, Juego, Set
Ø 4,5 / 5,0 - Ø 9,5 / 10,0 mm
(6 dilators)



PRATT

Ø 4,5 / 5,0 mm	180-370-05
Ø 5,5 / 6,0 mm	180-370-06
Ø 7,5 / 8,0 mm	180-370-08
Ø 8,5 / 9,0 mm	180-370-09
Ø 9,5 / 10,0 mm	180-370-10
Ø 11,5 / 12,0 mm	180-370-12
Ø 12,5 / 13,0 mm	180-370-13
Ø 13,5 / 14,0 mm	180-370-14

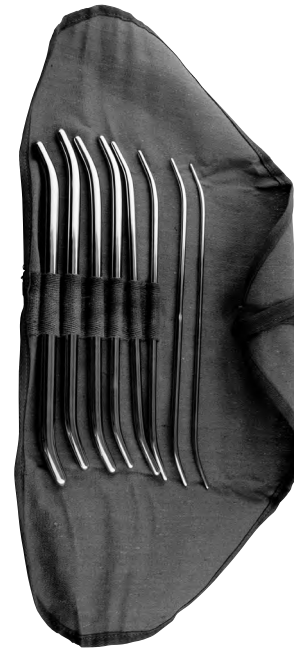

PRATT
180-370-98
 Satz, Set, Juego, Set
 Ø 4,5 / 5,0 - Ø 13,5 / 14,0 mm
 (8 dilators)



BARRETT
 18,0 cm, 7"
180-410-18



ADAIR
 19,0 cm, 7½"
180-412-19



STAUDE-MOORE
 17,0 cm, 6¾"
180-414-17





JARCHO
20,0 cm, 8"
180-417-20



SCHROEDER
25,0 cm, 9³/₄"
180-400-25



BRAUN
25,0 cm, 9³/₄"
180-404-25

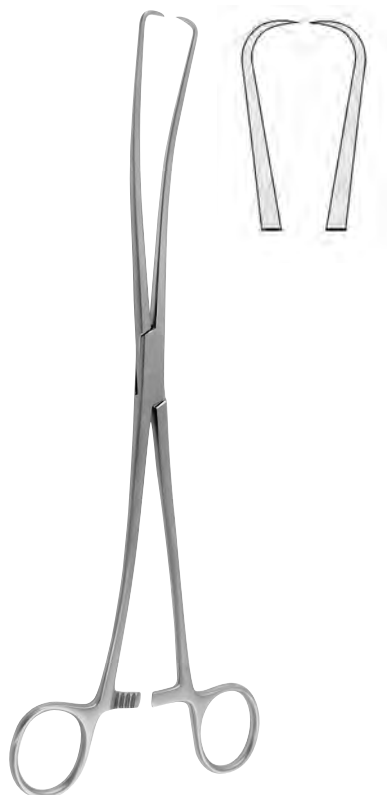

DUPLAY
28,0 cm, 11"
180-419-28



POZZI
26,0 cm, 10¹/₄"
180-402-26



KAHN
24,0 cm, 9¹/₂"
180-421-24



SKENE
24,0 cm, 9½"
180-423-24



SCHROEDER
24,0 cm, 9½"
180-426-24



SCHROEDER
24,0 cm, 9½"
180-429-24



TEALE
23,0 cm, 9"
180-431-23



JACOBS
21,0 cm, 8½"
180-434-21



JACOBS
21,0 cm, 8½"
180-435-21



MUSEUX
24,0 cm, 9 1/2"



MUSEUX
24,0 cm, 9 1/2"



BRAUN
15,5 cm, 6"
180-442-15



CZERNY
20,5 cm, 8"
180-444-20



PRATT
28,0 cm, 11"
180-446-28



IOWA
26,0 cm, 10 1/4"
180-449-26



DOYEN
20,5 cm, 8"
180-470-20

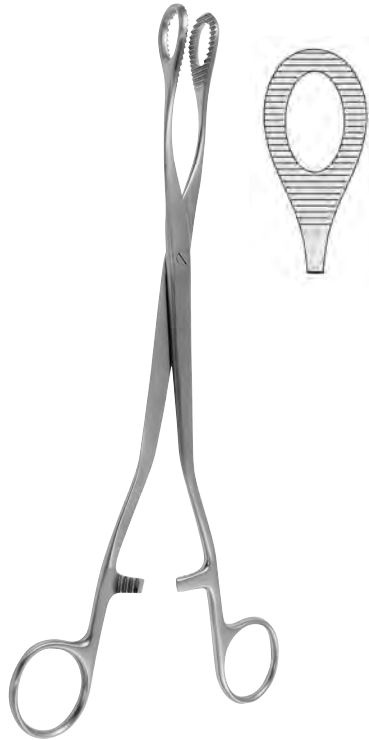

NOTO
27,0 cm, 10⁵/₈"
180-472-27

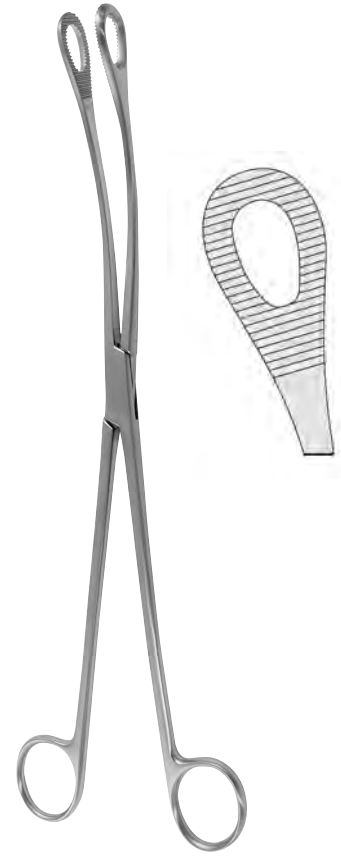

KELLY
32,0 cm, 12¹/₂"
180-475-32

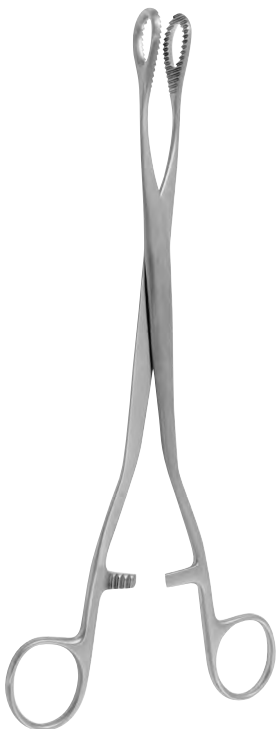

HEYWOOD-SMITH
25,0 cm, 9³/₄"
180-480-25



DARTIGUES
27,0 cm, 10³/₄"
180-482-27



SOMER
23,0 cm, 9"
180-485-23



COLLIN
25,0 cm, 9³/₄"
180-488-25



BEACHAM
26,0 cm, 10¹/₄"
180-500-26

Amniotom
Amniotome
Amniótomo
Amniotomo



BRAUN
28,0 cm, 11"
180-502-28

Uterus-Depressor
Uterine depressor
Depresor uterino
Depressori uterini



SIMS
32,0 cm, 12¹/₂"
180-510-32



SIMS
32,0 cm, 12¹/₂"
180-511-32

biegsam
malleable
maleable
malleabile



MARTIN
32,0 cm, 12¹/₂"
180-516-32



MARTIN
32,0 cm, 12¹/₂"
180-518-32

biegsam
malleable
maleable
malleabile



VALLEIX
25,0 cm, 10"
180-521-25

Ø 4 mm



SIMPSON
29,0 cm, 11¹/₂"
180-527-29

biegsam
malleable
maleable
malleabile

Ø 4 mm



COLLIN
28,0 cm, 11"
180-529-28



KEVORKIAN
30,0 cm, 12"
180-540-30

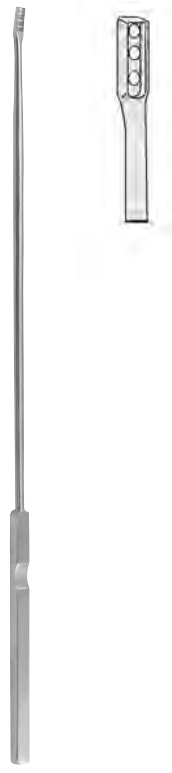

KEVORKIAN
30,0 cm, 12"
180-542-30



KEVORKIAN
30,0 cm, 12"
180-543-30



NOVAK
23,0 cm, 9"
180-550-04

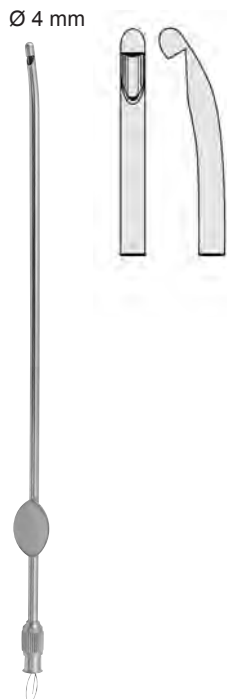

RANDALL
23,0 cm, 9"
180-552-04



MILAN
29,0 cm, 11 1/2"

Ø 4 mm
180-560-04

Ø 6 mm
180-560-06

Ø 9 mm
180-560-09



25,0 cm, 9³/₄"
180-570-25



25,0 cm, 9³/₄"
180-572-25



SIMON
22,0 cm, 8⁵/₈"
180-574-22



EMMETT
22,0 cm, 8⁵/₈"



180-576-01



180-576-02



180-576-03



180-576-04



180-576-05



SEGOND
27,0 cm, 10⁵/₈"
180-580-27

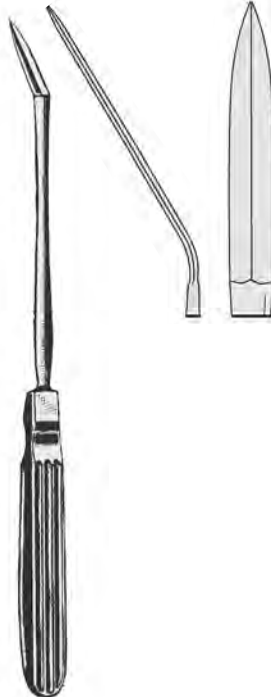

AYRE
23,0 cm, 9"
180-583-23



DOYEN
19,0 cm, 7¹/₂"
180-588-01



DOYEN
17,0 cm, 6³/₄"
180-588-02

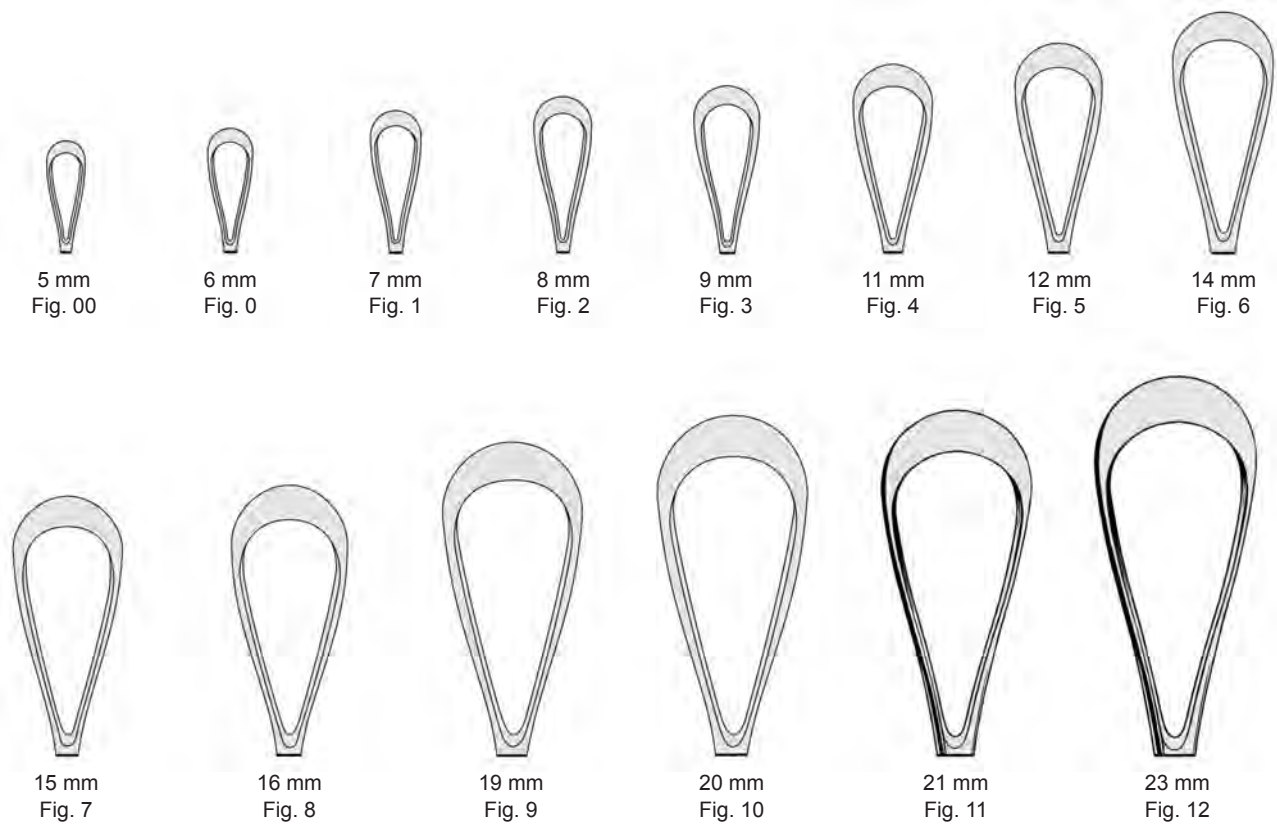

scharf, fest
sharp, rigid
cortantes, rígidas
acute, rigide

Fig. 00	180-700-05
Fig. 0	180-700-06
Fig. 1	180-700-07
Fig. 2	180-700-08
Fig. 3	180-700-09
Fig. 4	180-700-11
Fig. 5	180-700-12
Fig. 6	180-700-14
Fig. 7	180-700-15
Fig. 8	180-700-16
Fig. 9	180-700-19
Fig. 10	180-700-20
Fig. 11	180-700-21
Fig. 12	180-700-23

RECAMIER
26,0 cm, 10¹/₄"



scharf, biegsam
sharp, malleable
cortantes, maleable
acute, malleabile

Fig. 00	180-701-05
Fig. 0	180-701-06
Fig. 1	180-701-07
Fig. 2	180-701-08
Fig. 3	180-701-09
Fig. 4	180-701-11
Fig. 5	180-701-12
Fig. 6	180-701-14
Fig. 7	180-701-15
Fig. 8	180-701-16
Fig. 9	180-701-19
Fig. 10	180-701-20
Fig. 11	180-701-21
Fig. 12	180-701-23

RECAMIER
26,0 cm, 10¹/₄"

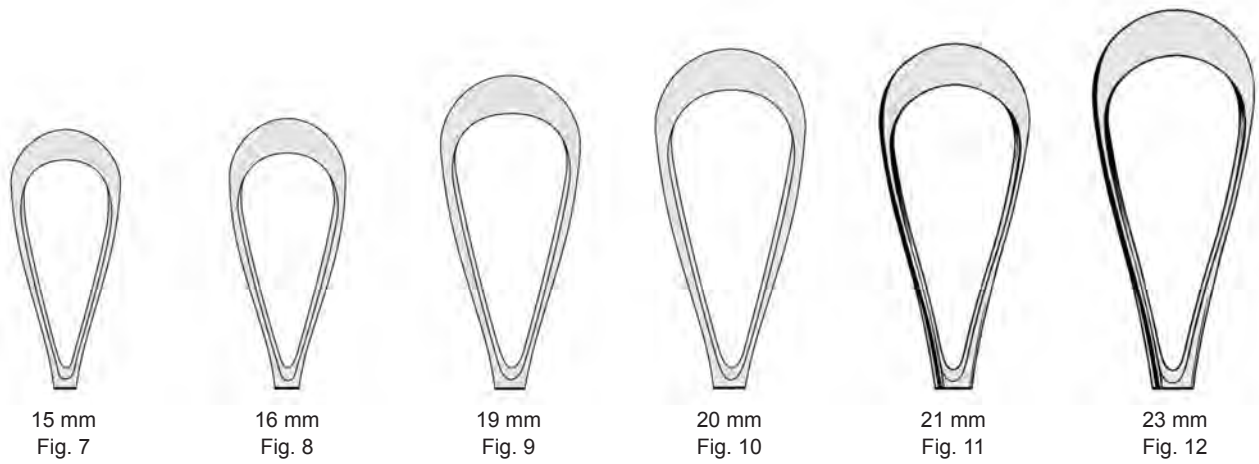
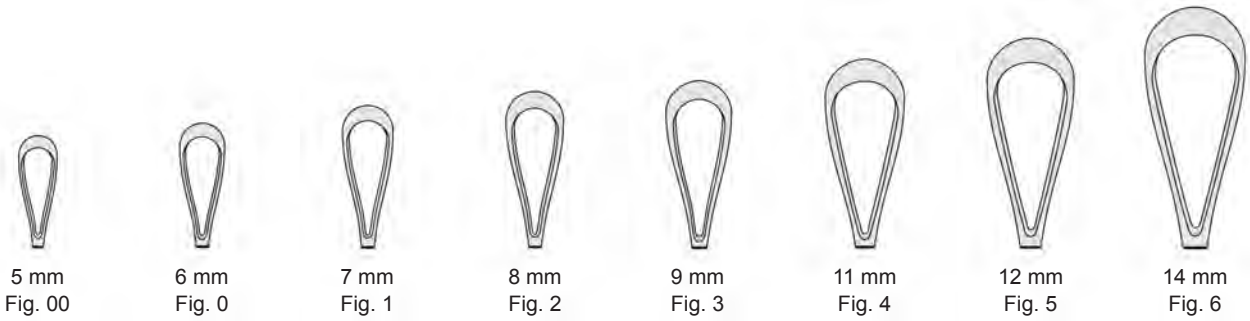

scharf, fest
sharp, rigid
cortantes, rígidas
acute, rigide

Fig. 00	180-702-05
Fig. 0	180-702-06
Fig. 1	180-702-07
Fig. 2	180-702-08
Fig. 3	180-702-09
Fig. 4	180-702-11
Fig. 5	180-702-12
Fig. 6	180-702-14
Fig. 7	180-702-15
Fig. 8	180-702-16
Fig. 9	180-702-19
Fig. 10	180-702-20
Fig. 11	180-702-21
Fig. 12	180-702-23

SIMS
26,0 cm, 10 1/4"



scharf, biegsam
sharp, malleable
cortantes, maleable
acute, malleabile

Fig. 00	180-703-05
Fig. 0	180-703-06
Fig. 1	180-703-07
Fig. 2	180-703-08
Fig. 3	180-703-09
Fig. 4	180-703-11
Fig. 5	180-703-12
Fig. 6	180-703-14
Fig. 7	180-703-15
Fig. 8	180-703-16
Fig. 9	180-703-19
Fig. 10	180-703-20
Fig. 11	180-703-21
Fig. 12	180-703-23

SIMS
26,0 cm, 10 1/4"

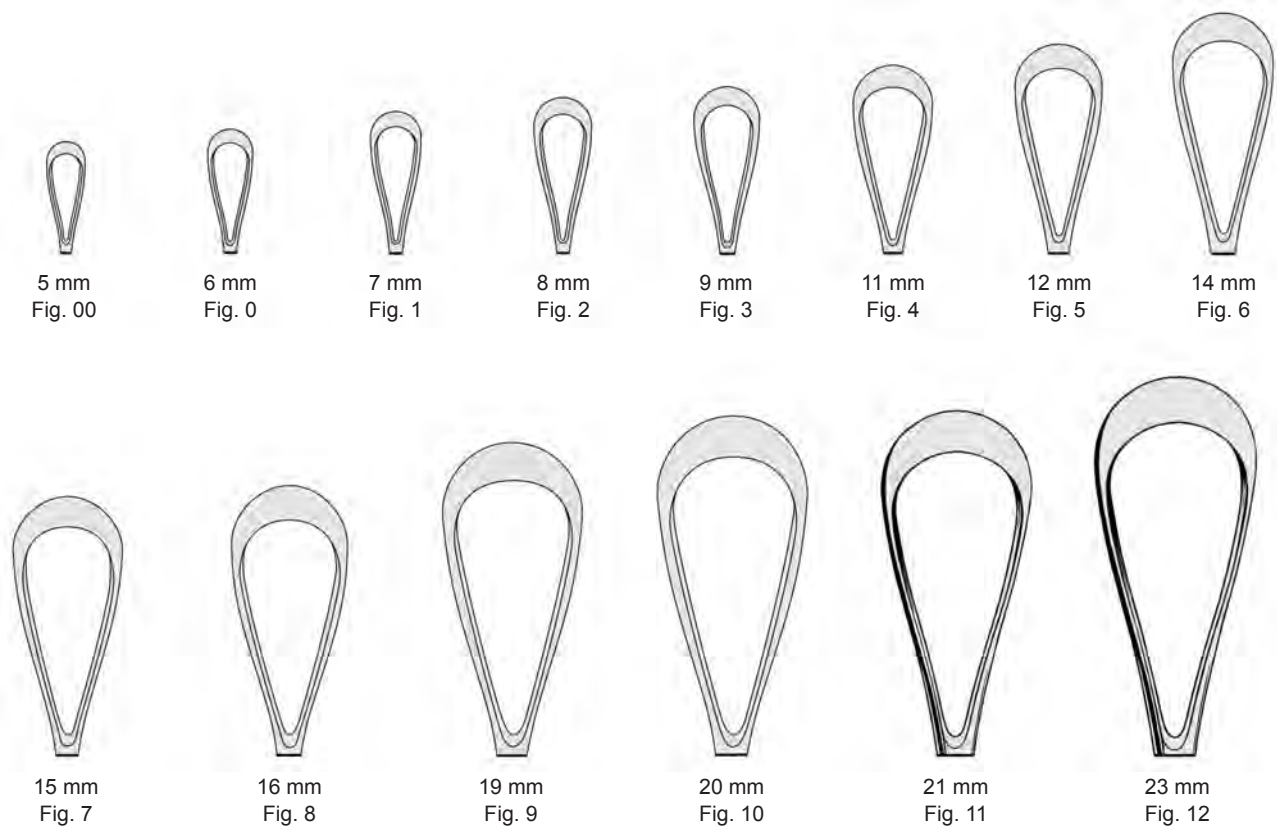

scharf, fest
sharp, rigid
cortantes, rígidas
acute, rigide

Fig. 00	180-710-05
Fig. 0	180-710-06
Fig. 1	180-710-07
Fig. 2	180-710-08
Fig. 3	180-710-09
Fig. 4	180-710-11
Fig. 5	180-710-12
Fig. 6	180-710-14
Fig. 7	180-710-15
Fig. 8	180-710-16
Fig. 9	180-710-19
Fig. 10	180-710-20
Fig. 11	180-710-21
Fig. 12	180-710-23

RECAMIER
31,0 cm, 12 1/4"



scharf, biegsam
sharp, malleable
cortantes, maleable
acute, malleabile

Fig. 00	180-711-05
Fig. 0	180-711-06
Fig. 1	180-711-07
Fig. 2	180-711-08
Fig. 3	180-711-09
Fig. 4	180-711-11
Fig. 5	180-711-12
Fig. 6	180-711-14
Fig. 7	180-711-15
Fig. 8	180-711-16
Fig. 9	180-711-19
Fig. 10	180-711-20
Fig. 11	180-711-21
Fig. 12	180-711-23

RECAMIER
31,0 cm, 12 1/4"



5 mm
Fig. 00



6 mm
Fig. 0



7 mm
Fig. 1



8 mm
Fig. 2



9 mm
Fig. 3



11 mm
Fig. 4



12 mm
Fig. 5



14 mm
Fig. 6



15 mm
Fig. 7



16 mm
Fig. 8



19 mm
Fig. 9



20 mm
Fig. 10



21 mm
Fig. 11



23 mm
Fig. 12

scharf, fest
sharp, rigid
cortantes, rígidas
acute, rigide

scharf, biegsam
sharp, malleable
cortantes, maleable
acute, malleabile

Fig. 00	180-712-05
Fig. 0	180-712-06
Fig. 1	180-712-07
Fig. 2	180-712-08
Fig. 3	180-712-09
Fig. 4	180-712-11
Fig. 5	180-712-12
Fig. 6	180-712-14
Fig. 7	180-712-15
Fig. 8	180-712-16
Fig. 9	180-712-19
Fig. 10	180-712-20
Fig. 11	180-712-21
Fig. 12	180-712-23

Fig. 00	180-713-05
Fig. 0	180-713-06
Fig. 1	180-713-07
Fig. 2	180-713-08
Fig. 3	180-713-09
Fig. 4	180-713-11
Fig. 5	180-713-12
Fig. 6	180-713-14
Fig. 7	180-713-15
Fig. 8	180-713-16
Fig. 9	180-713-19
Fig. 10	180-713-20
Fig. 11	180-713-21
Fig. 12	180-713-23

SIMS
31,0 cm, 12¹/₄"

SIMS
31,0 cm, 12¹/₄"

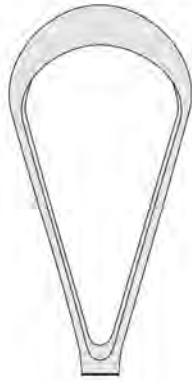

30 mm
Fig. 1

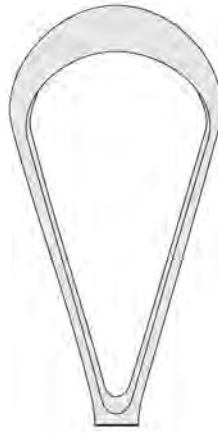

35 mm
Fig. 2

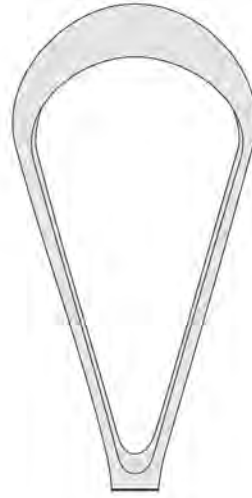

40 mm
Fig. 3



scharf, fest
sharp, rigid
cortantes, rígidas
acute, rigide

Fig. 1 **180-720-30**
Fig. 2 **180-720-35**
Fig. 3 **180-720-40**

SIMS
31,0 cm, 12¹/₄"



scharf, biegsam
sharp, malleable
cortantes, maleable
acute, malleabile

Fig. 1 **180-721-30**
Fig. 2 **180-721-35**
Fig. 3 **180-721-40**

SIMS
31,0 cm, 12¹/₄"



30 mm
Fig. 1

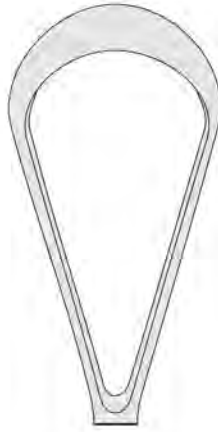

35 mm
Fig. 2



40 mm
Fig. 3



scharf, fest
sharp, rigid
cortantes, rígidas
acute, rigide

Fig. 1 **180-722-30**
Fig. 2 **180-722-35**
Fig. 3 **180-722-40**

BUMM
31,0 cm, 12¹/₄"



scharf, biegsam
sharp, malleable
cortantes, maleable
acute, malleabile

Fig. 1 **180-723-30**
Fig. 2 **180-723-35**
Fig. 3 **180-723-40**

BUMM
31,0 cm, 12¹/₄"



BLAKE
27,0 cm, 10⁵/₈"
180-750-27



SIMON
25,0 cm, 9³/₄"

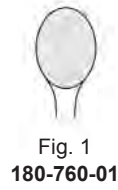

THOMS-GAYLOR
22,0 cm, 8⁵/₈" 180-680-22
24,0 cm, 9¹/₂" 180-680-24



SCHUBERT
21,0 cm, 8¹/₄" 180-682-21
29,0 cm, 11¹/₂" 180-682-29



SCHUMACHER-VAN DOREN
24,0 cm, 9¹/₂"
180-684-24

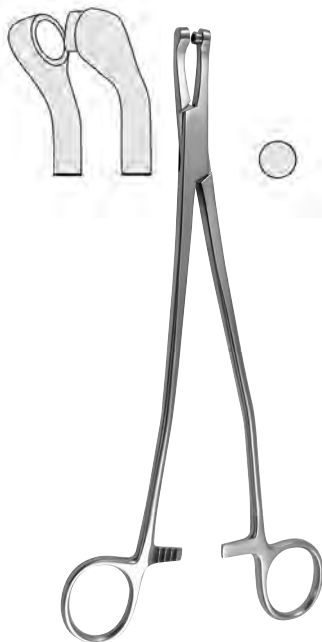

THOMS-GAYLOR
24,0 cm, 9½"
180-686-24



FAURE
21,0 cm, 8¼"
180-688-21

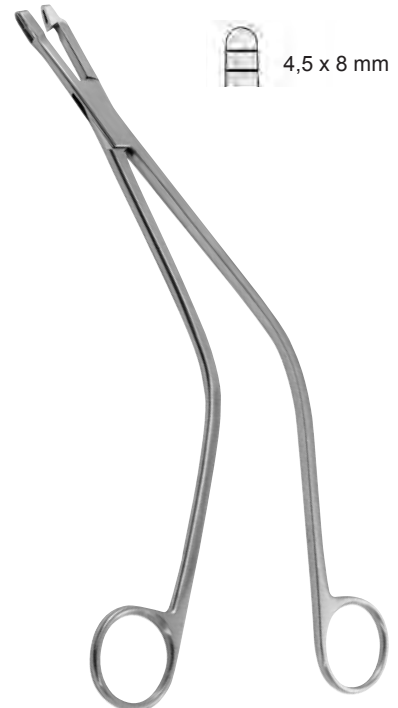

SCHUBERT
26,0 cm, 10¼"
180-690-26

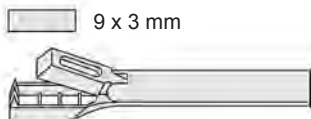

KEVORKIAN
25,0 cm, 10"
180-602-25

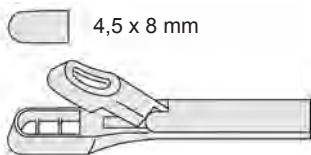

EPPENDORFER
20,0 cm, 8"
180-604-20

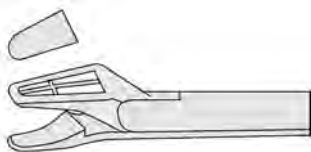

ALEXANDER
28,0 cm, 11"
180-608-28

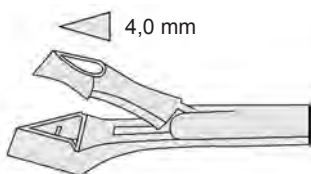

SCHUMACHER
24,0 cm, 9½"
180-610-04

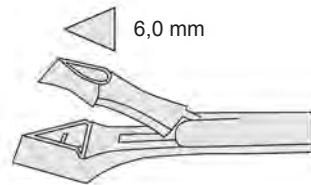

SCHUMACHER
24,0 cm, 9½"
180-610-06

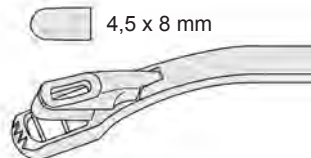

WITTNER
23,0 cm, 9"
180-615-23

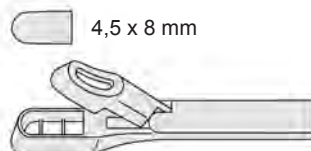

WITTNER
23,0 cm, 9"
180-614-23

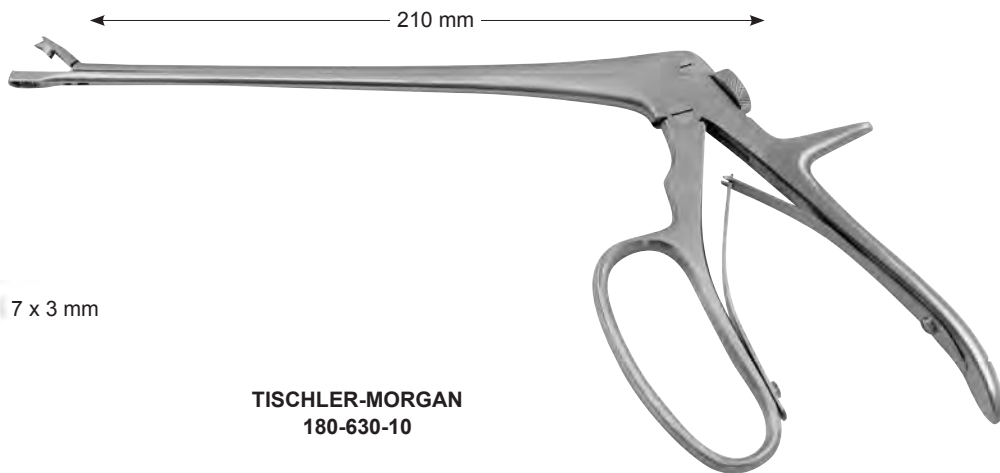
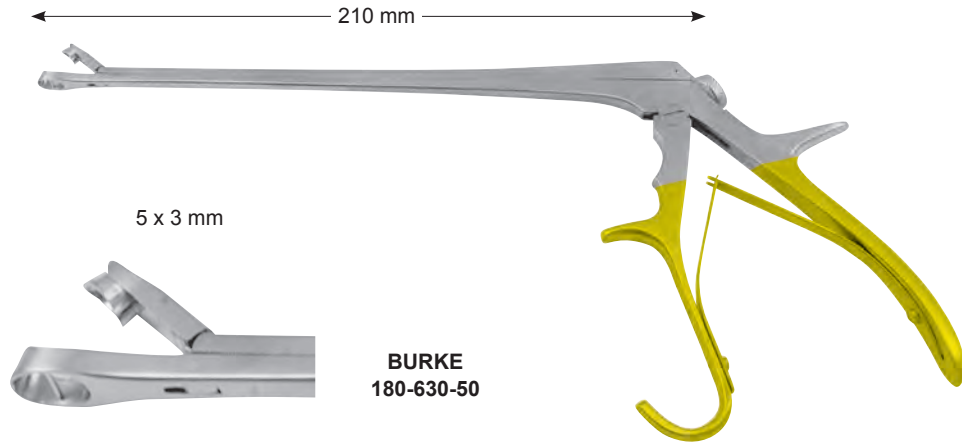

2,3 x 4 mm

MINI-TOWNSEND
180-630-12

9 x 3 mm

TISCHLER-KEVORKIAN
180-630-41

2,3 x 4 mm

BABY-TISCHLER
180-630-14

9 x 3 mm

KEVORKIAN-PACIFIC
180-630-40



WRIGLEY
28,0 cm, 11"
181-056-28



SIMPSON
30,0 cm, 11³/₄"
181-034-30



SIMPSON-BRAUN
33,0 cm, 13"
181-036-33



SIMPSON-BRAUN
36,0 cm, 14¹/₈"
181-036-36



SIMPSON-LUIKART
36,0 cm, 14¹/₈"
181-046-36



DE LEE
30,0 cm, 11³/₄"
181-058-30



DE LEE
36,0 cm, 14¹/₈"
181-058-36



DE LEE
38,0 cm, 15³/₈"
181-058-38



MC LEAN
36,0 cm, 14¹/₈"
181-044-36



KIELAND
41,0 cm, 16"
181-052-41



KIELAND-LUIKART
40,0 cm, 15³/₄"
181-054-40



PIPER
44,0 cm, 17¹/₄"
181-060-44



ELLIOT
32,0 cm, 12¹/₂"
181-080-32



ELLIOT
38,0 cm, 15"
181-080-38



NAEGELE
36,0 cm, 14¹/₈"
181-084-36



NAEGELE
40,0 cm, 15³/₄"
181-084-40



GREEN-ARMYTAGE
21,0 cm, 8¹/₄"
181-200-21

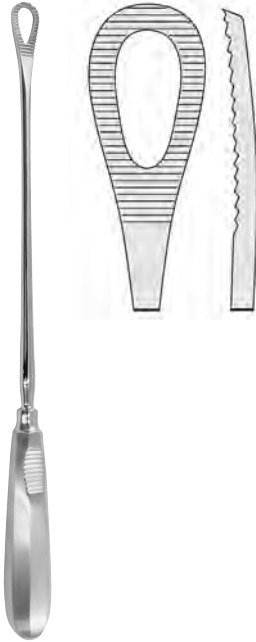

PESTALOZZA
30,0 cm, 11³/₄"
181-252-30



SAENGER
27,0 cm, 10⁵/₈"
181-260-27



SAENGER
27,0 cm, 10⁵/₈"
181-261-27



WINTER
28,0 cm, 11"



Fig. 1
181-244-01



Fig. 2
181-244-02



Fig. 3
181-244-03



Fig. 1
181-245-01



Fig. 2
181-245-02



Fig. 3
181-245-03



WALLICH
42,0 cm, 16¹/₂"
181-300-42



MARTIN
34,0 cm, 13³/₈"
181-600-34

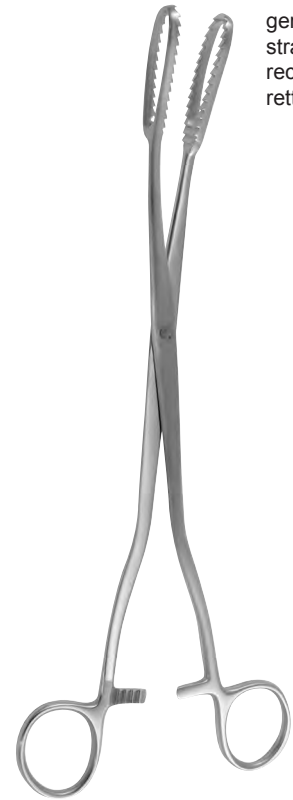

gerade
straight
recto
retto

BIERER
33,0 cm, 13"
58-1236-01



gerade
straight
recto
retto

BIERER
33,0 cm, 13"
181-236-02



gebogen
curved
curvo
curvo

BIERER
33,0 cm, 13"
181-237-01



gebogen
curved
curvo
curvo

BIERER
33,0 cm, 13"
181-237-02

Preparation, Dermatology



PIFFARD
14,0 cm, 5³/₄"

Lupusküretten
Lupus currettes
Curetas para lupus
Raschiatoio per lupus



KEYES
12,0 cm, 4³/₄"

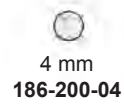
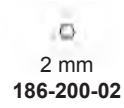

KEYES
12,0 cm, 4³/₄"
186-210-00



186-400-01



186-400-02



186-400-03

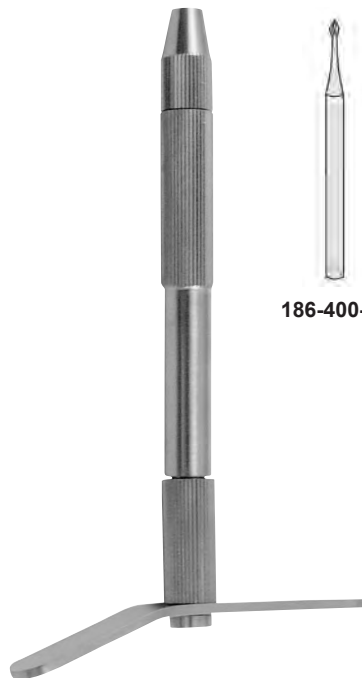

186-400-00
komplett, complete,
completo, completo,



UNNA
14,0 cm, 5³/₄"
186-000-14



UNNA
14,0 cm, 5³/₄"
186-002-14



SAALFELD
10,0 cm, 4"
186-010-10



SAALFELD
14,0 cm, 5³/₄"
186-012-14



SCHAMBERG
10,0 cm, 4"
186-020-10



WALTON
14,0 cm, 5³/₄"
186-030-14



FOX
14,0 cm, 5³/₄"



Lupusküretten
Lupus cures
Curetas para lupus
Raschiatoio per lupus



186-420-01

17,0 cm, 6³/₄"
186-420-17

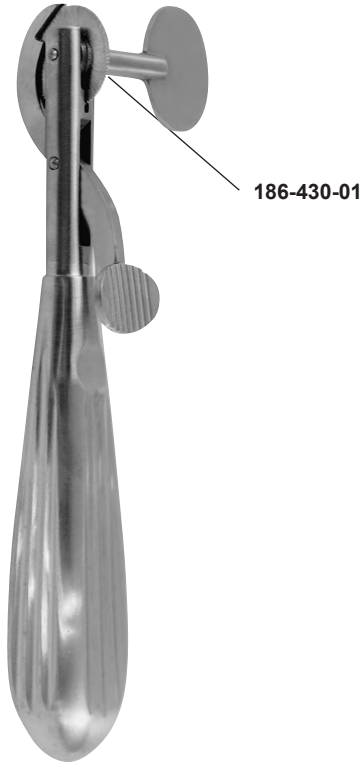

186-430-01

WALTON
16,0 cm, 6¹/₄"
186-430-16



RADOLF
13,5 cm, 5³/₈"
186-500-13



13,5 cm, 5³/₈"
186-510-13



13,0 cm, 5"
186-600-13



186-610-01

186-610-02

14,0 cm, 5¹/₂"

Bone Surgery



SCHUDE
17,0 cm, 6³/₄"

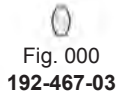

Fig. 000
192-467-03

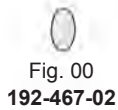

Fig. 00
192-467-02



Fig. 0
192-467-01



Fig. 1
192-467-11



Fig. 2
192-467-12

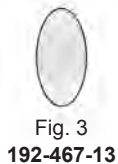

Fig. 3
192-467-13



Fig. 4
192-467-14



VOLKMANN
17,0 cm, 6³/₄"



Fig. 0000
192-469-04



Fig. 000
192-469-03



Fig. 00
192-469-02



Fig. 0
192-469-01



Fig. 1
192-469-11



Fig. 2
192-469-12

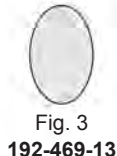

Fig. 3
192-469-13

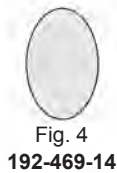

Fig. 4
192-469-14



Fig. 5
192-469-15



Fig. 6
192-469-16



BRUNS
17,0 cm, 6³/₄"

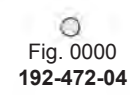

Fig. 0000
192-472-04



Fig. 000
192-472-03



Fig. 00
192-472-02



Fig. 0
192-472-01



Fig. 1
192-472-11



Fig. 2
192-472-12



Fig. 3
192-472-13



Fig. 4
192-472-14



Fig. 5
192-472-15



Fig. 6
192-472-16

Fig. 00000
192-448-04

Fig. 0000
192-448-03

Fig. 000
192-448-02

Fig. 00
192-448-01

Fig. 0
192-448-00



LEMPERT
21,5 cm, 8½"



HALLE
21,0 cm, 8¼"

Fig. 00
192-452-02

Fig. 0
192-452-01

Fig. 1
192-452-11



DAUBENSPECK
20,0 cm, 8"

Fig. 00
192-487-02

Fig. 0
192-487-01

Fig. 1
192-487-11

Fig. 2
192-487-12



WILLIGER
17,0 cm, 6³/₄"



Fig. 1
192-430-11



Fig. 2
192-430-12



WILLIGER
14,0 cm, 5¹/₂"

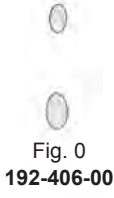

Fig. 0
192-406-00



Fig. 1
192-406-01

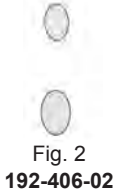

Fig. 2
192-406-02



MARTINI
14,0 cm, 5¹/₂"
192-408-00



Fig. 00/0
192-408-00
14,0 cm, 5¹/₂"

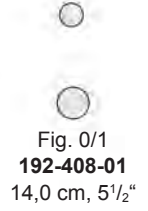

Fig. 0/1
192-408-01
14,0 cm, 5¹/₂"



Fig. 1/2
192-408-12
14,0 cm, 5¹/₂"



VOLKMAN



192-414-13
13,0 cm, 5"



192-414-14
14,0 cm, 5¹/₂"



192-414-17
17,0 cm, 6³/₄"

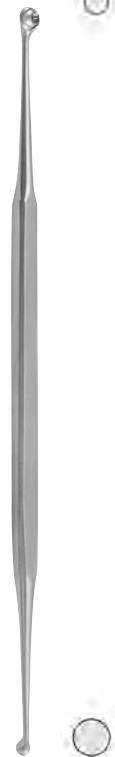

JANSEN
16,0 cm, 6¹/₄"
192-410-16



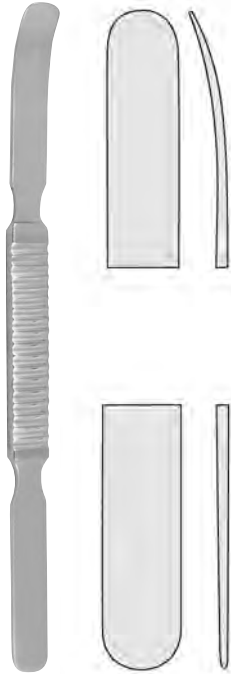

WATSON-CHEYNE
17,5 cm, 6⁵/₈"
193-501-17



MC DONALD
19,0 cm, 7¹/₂"
193-440-19



WILLIGER
17,0 cm, 6³/₄"
193-512-17



WILLIGER
16,0 cm, 6¹/₄"
193-512-16

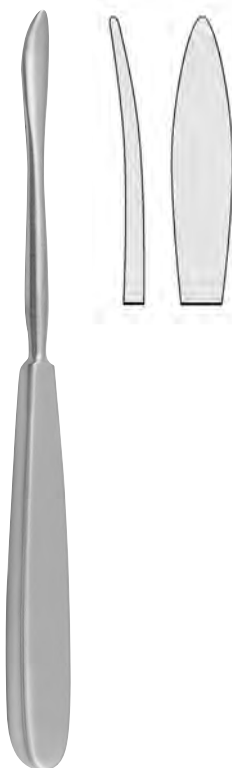

LANGENBECK
20,0 cm, 8"
193-520-08

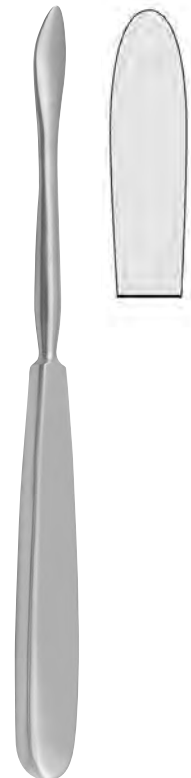

LANGENBECK
20,0 cm, 8"
193-520-10



ADSON
17,0 cm, 6³/₄"



8 mm
193-465-01

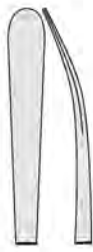

7 mm
193-465-02



7 mm
193-465-03



7 mm
193-465-04



KÖNIG
15,5 cm, 6"
193-476-15

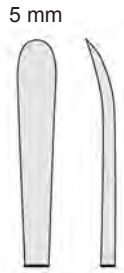

5 mm



LAMBOTTE
21,0 cm, 8¹/₄"



10 mm
193-477-10



15 mm
193-477-15



20 mm
193-477-20



25 mm
193-477-25

12,5 mm



FARABEUF
15,0 cm, 6"
193-478-15



12,5 mm

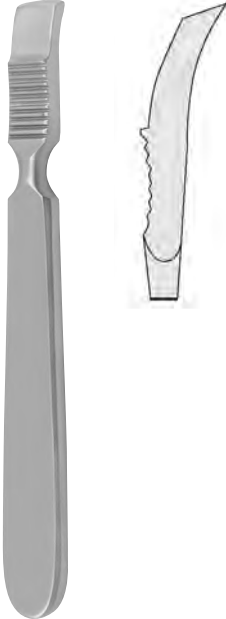

FARABEUF
15,0 cm, 6"
193-479-15

16,0 mm



LANGENBECK
19,0 cm, 7 1/2"
193-472-19

15,0 mm



SEDILLOT
21,0 cm, 8 1/4"
193-488-21



4 mm **193-480-04**
6 mm **193-480-06**
8 mm **193-480-08**

WILLIGER
16,0 cm, 6 1/4"



für Kinder
for children
para niños
per bambini

DOYEN
17,0 cm, 6 3/4"
193-485-17



für Kinder
for children
para niños
per bambini

DOYEN
17,0 cm, 6 3/4"
193-487-17



für Erwachsene
for adults
para adultos
per adulti дп

DOYEN
17,0 cm, 6 3/4"
193-481-17



für Erwachsene
for adults
para adultos
per adulti

DOYEN
17,0 cm, 6 3/4"
193-483-17

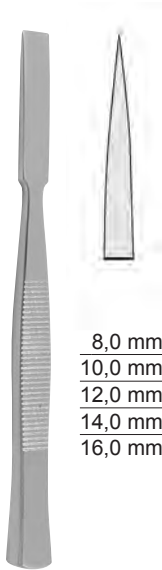

8,0 mm
10,0 mm
12,0 mm
14,0 mm
16,0 mm

194-300-08
194-300-10
194-300-12
194-300-14
194-300-16

13,5 cm, 5³/₈"

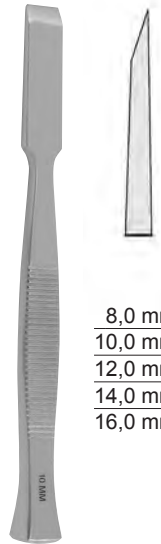

8,0 mm
10,0 mm
12,0 mm
14,0 mm
16,0 mm

194-301-08
194-301-10
194-301-12
194-301-14
194-301-16

13,5 cm, 5³/₈"

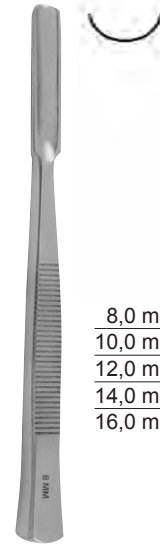

8,0 mm
10,0 mm
12,0 mm
14,0 mm
16,0 mm

194-302-08
194-302-10
194-302-12
194-302-14
194-302-16

13,5 cm, 5³/₈"



3,0 mm
4,0 mm
5,0 mm
6,0 mm

194-334-03
194-334-04
194-334-05
194-334-06

PARTSCH
13,5 cm, 5³/₈"



3,0 mm
4,0 mm
5,0 mm
6,0 mm

194-336-03
194-336-04
194-336-05
194-336-06

PARTSCH
13,5 cm, 5³/₈"



10,0 mm
15,0 mm
20,0 mm
25,0 mm

194-361-10
194-361-15
194-361-20
194-361-25

STILLE
20,0 cm, 8"



10,0 mm **194-360-10**
 15,0 mm **194-360-15**
 20,0 mm **194-360-20**
 25,0 mm **194-360-25**

STILLE
20,0 cm, 8"

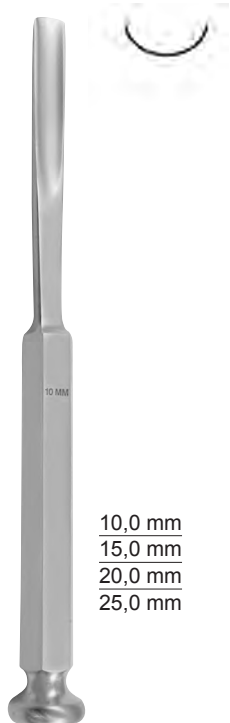

10,0 mm **194-362-10**
 15,0 mm **194-362-15**
 20,0 mm **194-362-20**
 25,0 mm **194-362-25**

STILLE
20,0 cm, 8"



4,0 mm **194-318-04**
 6,0 mm **194-318-06**
 8,0 mm **194-318-08**
 10,0 mm **194-318-10**
 12,0 mm **194-318-12**
 14,0 mm **194-318-14**

ALEXANDER
18,0 cm, 7"

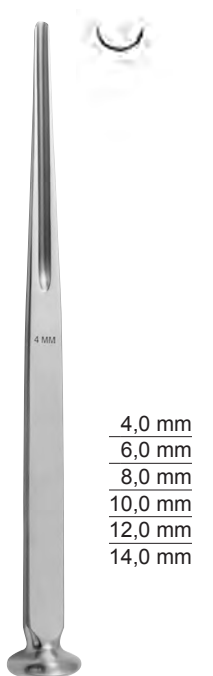

4,0 mm **194-319-04**
 6,0 mm **194-319-06**
 8,0 mm **194-319-08**
 10,0 mm **194-319-10**
 12,0 mm **194-319-12**
 14,0 mm **194-319-14**

ALEXANDER
18,0 cm, 7"

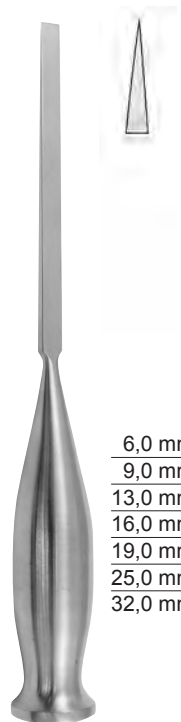

6,0 mm **194-350-06**
 9,0 mm **194-350-09**
 13,0 mm **194-350-13**
 16,0 mm **194-350-16**
 19,0 mm **194-350-19**
 25,0 mm **194-350-25**
 32,0 mm **194-350-32**

SMITH-PETERSEN
20,0 cm, 8"



6,0 mm **194-351-06**
 9,0 mm **194-351-09**
 13,0 mm **194-351-13**
 16,0 mm **194-351-16**
 19,0 mm **194-351-19**
 25,0 mm **194-351-25**
 32,0 mm **194-351-32**

SMITH-PETERSEN
20,0 cm, 8"



9,0 mm
14,0 mm
16,0 mm
19,0 mm
25,0 mm

194-352-09
194-352-14
194-352-16
194-352-19
194-352-25

SMITH-PETERSEN
20,0 cm, 8"



9,0 mm
14,0 mm
16,0 mm
19,0 mm
25,0 mm

194-353-09
194-353-14
194-353-16
194-353-19
194-353-25

SMITH-PETERSEN
20,0 cm, 8"



6,0 mm
15,0 mm
20,0 mm
25,0 mm
30,0 mm
38,0 mm
44,0 mm
50,0 mm

194-450-06
194-450-15
194-450-20
194-450-25
194-450-30
194-450-38
194-450-44
194-450-50

LAMBOTTE
24,0 cm, 9 1/2"

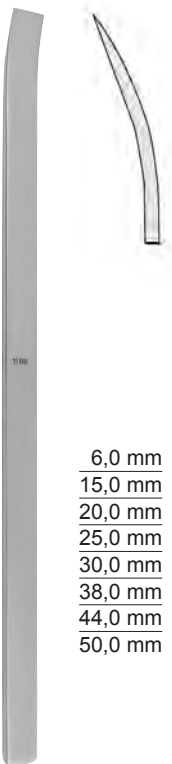

6,0 mm
15,0 mm
20,0 mm
25,0 mm
30,0 mm
38,0 mm
44,0 mm
50,0 mm

194-451-06
194-451-15
194-451-20
194-451-25
194-451-30
194-451-38
194-451-44
194-451-50

LAMBOTTE
24,0 cm, 9 1/2"

Ø 30 mm
220 g



COLLIN
20,0 cm, 8"
191-132-20

Ø 22 mm
200 g



PARTSCH
18,0 cm, 7"
191-145-18

mit Bleifüllung
lead filled head
cabezal relleno de plomo
testa di piombo

Ø 45 mm
300 g



BERGMANN
24,0 cm, 9 1/2"
191-201-24

Sterilization



20,0 cm, 8"
250-160-20



CHEATTLE
27,0 cm, 10⁵/₈"
250-163-27



ROGGE
23,0 cm, 9"
250-164-23

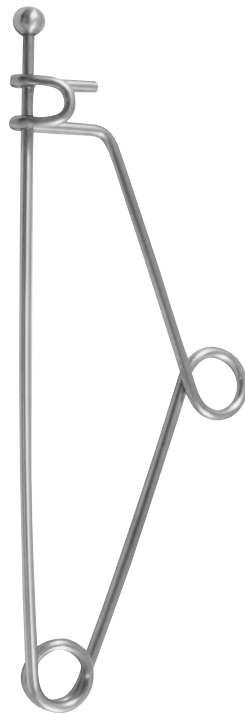

MAYO
14,0 cm, 5¹/₂"
250-151-14



BUNT
12,0 cm, 4³/₄"
250-154-12



Ø 75 x 130 mm	250-142-06
Ø 75 x 175 mm	250-142-07
Ø 100 x 175 mm	250-142-08
Ø 100 x 200 mm	250-142-09



Ø 40,0 mm	250-130-04
Ø 60,0 mm	250-130-06
Ø 80,0 mm	250-130-08
Ø 100,0 mm	250-130-10
Ø 120,0 mm	250-130-12
Ø 150,0 mm	250-130-15



165 x 55 mm	0,75 l	250-133-00
175 x 70 mm	1,00 l	250-133-10
225 x 100 mm	2,00 l	250-133-20
240 x 95 mm	2,75 l	250-133-30
260 x 120 mm	4,00 l	250-133-40
290 x 100 mm	5,00 l	250-133-50
315 x 150 mm	5,50 l	250-133-60
325 x 135 mm	8,00 l	250-133-70
360 x 165 mm	12,00 l	250-133-80
415 x 150 mm	14,00 l	250-133-90



170 mm	250-140-17
250 mm	250-140-25
275 mm	250-140-27



250-300-00
 Ø 65 x 17 mm
 Außen- und Innendose
 Exterior and interior box
 Caja exterior e interior
 Scatola esterna es interiore

250-300-01
 Ø 62 x 13 mm
 Innendose allein
 Interior box only
 Caja interior, suelta
 Scatola interiore sola



200 x 150 x 25 mm	250-200-01
260 x 180 x 30 mm	250-200-02
300 x 220 x 30 mm	250-200-03
350 x 220 x 40 mm	250-200-04
220 x 170 x 50 mm	250-200-05
280 x 200 x 50 mm	250-200-06
320 x 240 x 50 mm	250-200-07
370 x 270 x 50 mm	250-200-08
420 x 320 x 50 mm	250-200-09



25 ccm
250-310-25



50 ccm
250-310-50



Bürstenspender für 10 Bürsten
Brush dispenser for 10 brushes
Distribuidor de cepillos para 10 cepillos
Distributore per 10 spazzole
260 x 155 x 65 mm
250-800-01

Bürstenspender für 20 Bürsten
Brush dispenser for 20 brushes
Distribuidor de cepillos para 20 cepillos
Distributore per 20 spazzole
270 x 240 x 65 mm
250-800-02

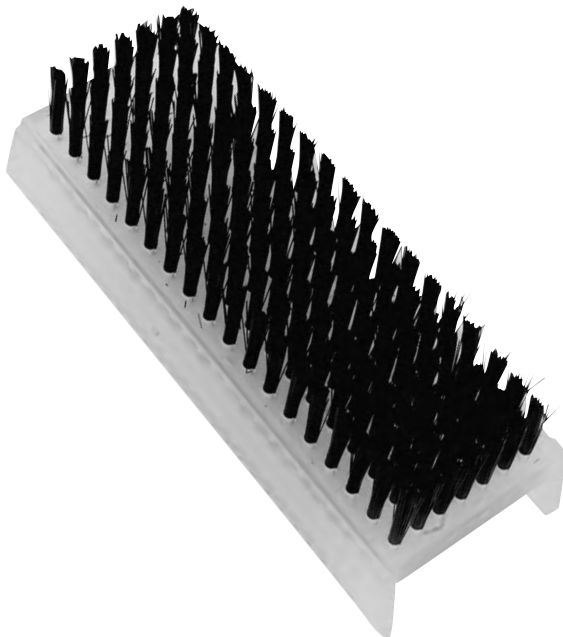

250-800-10

mehr als 400x autoklavierbar
more than 400 times autoclavable
esterilizable màs de 400 veces en autoclave
sterilizzabile piú di 400 volte in autoclave



Address: 9-KM Daska Road, Near PSO Filling Station.

Tell: +92 52 352 4035-36

Cell: +92 321 861 0165

Email: info@rimzasurgident.com

Email: atiqueratra@icloud.com

Email: sheikh@rimzasurgident.com

Email: ibrahim@rimzasurgident.com

Email: usman@rimzasurgident.com

Our Distributor in Oman & Middle East

Zayed Development and Services

Oman

Muscat

C.R 1540692

Mob / Whats up: +96890454563

